

# THE AVION

MFG. EXPORT. CO

High Grade Dental Instruments



## Dental

INSTRUMENTS  
CATALOGUE



# Company Profile

**“THE AVION VALUES THE TIME & QUALITY”**

## **Introduction**

The Avion is a Mfg. Export Company with 30 Years of Experience

We are a team of Expertise who committed to deliver the Excellent Quality of Instruments to make sure the perfection of Professionals.

We are proud to be a part of such sacred profession, saving lives by providing excellent quality of Instruments at very competitive prices since 30 Years

## **Our Philosophy**

Our philosophy is to share our knowledge and experience with our customers and give them all the professional assistance they might need.

## **Company's Policy**

The Avion do not compromise on quality of the products. We achieve quality excellence by using quality assurance programs and techniques. Prompt and dedicated services shall be ensured to customers and efficiently to the best of our ability.

## **Our Commitment**

Our commitment to quality, based on our continuous monitoring at every stage of the manufacturing process has placed us at par with international standards, while maintaining very competitive prices. Quality Management System, The Avion manufacturing, process emphasizes quality above all else. Our employees are requested a ten to fifteen-years technical and practical experience in order to achieve Quality. The proper stainless steel, stamping and forged materials used are meticulously selected and go through highly effective quality control.

## **Our Staff**

We are convinced that a highly qualified staff brings trust in our company. We are tight team, consisting of people, who with their education and experience contribute to our company strength.

## **Support**

Our friendly and well trained support staff is happy to assist you in any way even if you are looking for something not in our product range. We will do our best to help you.

## **Vision & Goals**

To be the first choice through deliver high-quality ,value –added : cost –effective services & services on schedule that exceed our client’s expectations .This is achieved by allocating sufficient ,resources ,experts and dedicated teams ,outstanding performance ,and professional integrity .



**M.D.  
Muhammad Abbas**



# MISSION STATEMENT

## “THE AVION VALUES THE TIME & QUALITY”

### Organization Chart

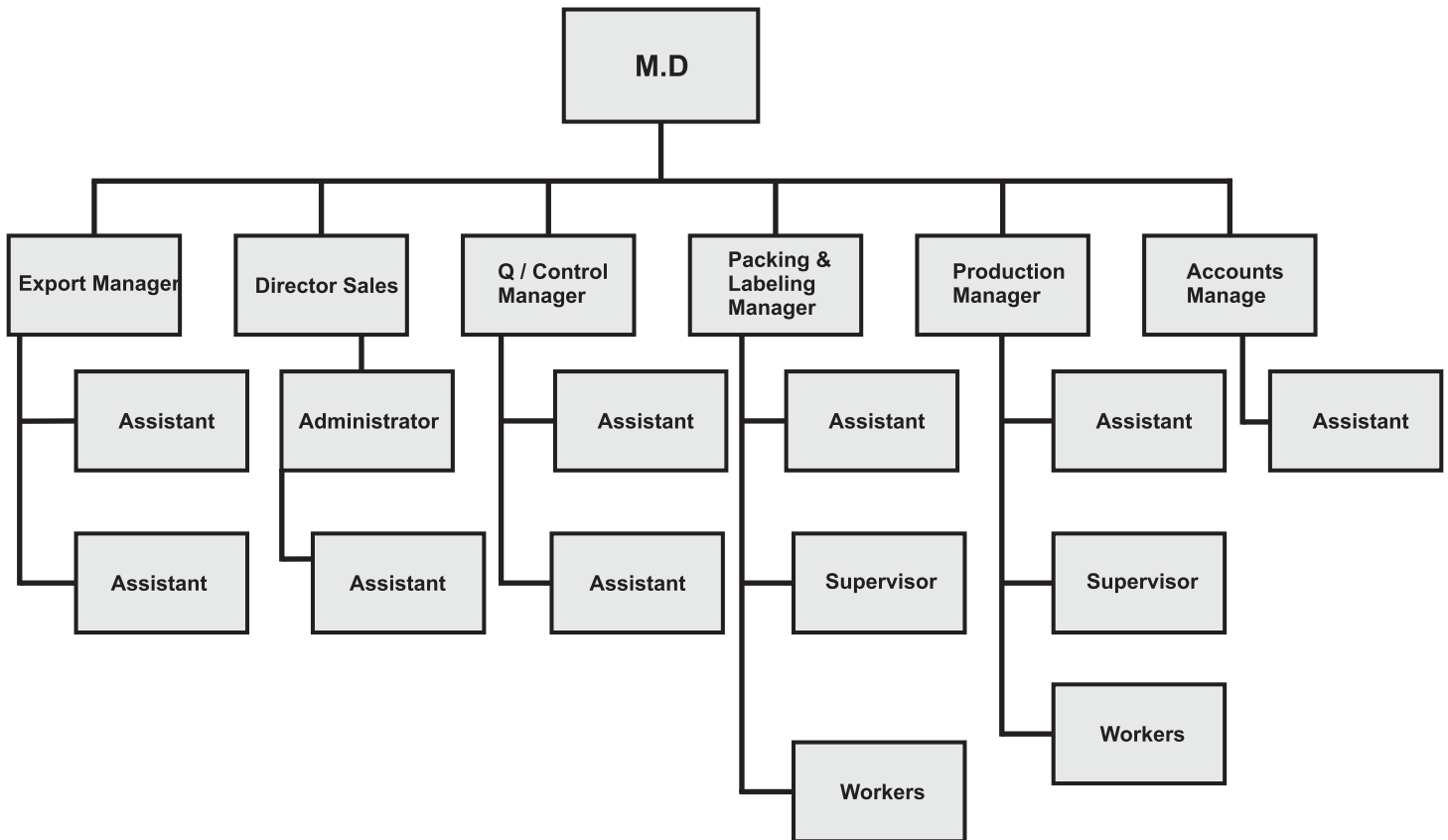

### Process Flow Chart

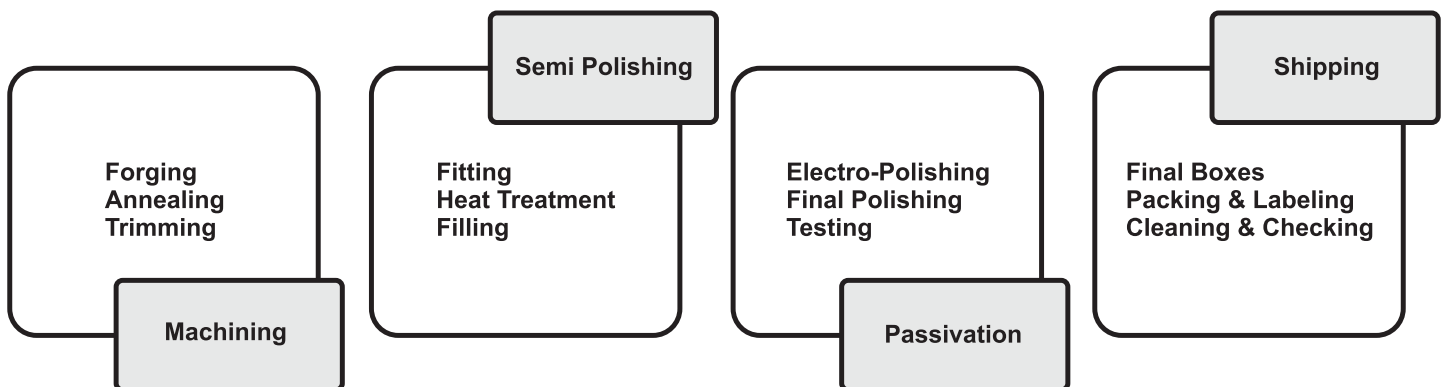

# Dental Instruments



**THE AVION**  
MFG. EXPORT. CO



# Table Of Contents

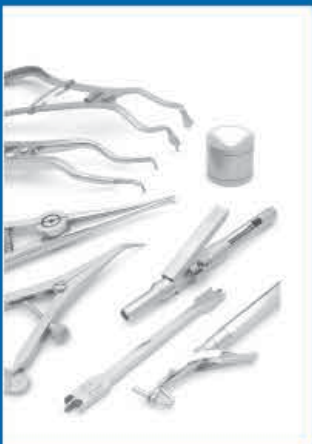



## Table of Contents



<b>01</b>	<b>Tooth Extracting Forceps</b>	<b>  01-49</b>	
<b>02</b>	<b>Root Elevators</b>	<b>  50-70</b>	
<b>03</b>	<b>Scalpel Handles, Handles, Mouth Mirrors Scalers, Explorer / Probes</b>	<b>  71-85</b>	
<b>04</b>	<b>Endodontic Condensers, Obturation Instruments Excavators, Explorer / Probes, Curette Sets</b>	<b>  86-96</b>	
<b>05</b>	<b>Amalgam Pluggers / Condensers, Burnishers</b>	<b>  97-100</b>	
<b>06</b>	<b>Wax Carvers, Carvers, Chisels</b>	<b>  101-103</b>	
<b>07</b>	<b>Compsite Placement, Plastic Filling Instruments</b>	<b>  104-107</b>	
<b>08</b>	<b>Curettes, Gracey Curettes, Dental Products, Knives</b>	<b>  108-117</b>	
<b>09</b>	<b>Wax Porcelain &amp; Cement Instruments Wax &amp; Modeling Instruments</b>	<b>  118-121</b>	
<b>10</b>	<b>Spatulas, Cement Spatulas</b>	<b>  122-124</b>	
<b>11</b>	<b>Files, Hoes, Knives, Wax &amp; Plaster Knives, Crane Kaplan</b>	<b>  125-128</b>	
<b>12</b>	<b>Bone Curettes, Bone Files, Bone Chisels, Bone Mallets</b>	<b>  129-133</b>	
<b>13</b>	<b>Crown Removers, Crown Instruments</b>	<b>  134-136</b>	





## Table of Contents



<b>14</b>	<b>Implants &amp; Measuring Instruments, Suction Tubes, Bone Gauges</b>	<b>  137-144  </b>	<b>██████████</b>
<b>15</b>	<b>Amalgam Guns &amp; Carriers, Retainers, Bands, Strip Holders, Napkin Holders</b>	<b>  145-146  </b>	<b>██████████</b>
<b>16</b>	<b>Rubber Dam Instruments, Rubber Dam Clamps</b>	<b>  147-148  </b>	<b>██████████</b>
<b>17</b>	<b>Syringes, Tweezers, Sterilizing &amp; Lab Instruments</b>	<b>  149-156  </b>	<b>██████████</b>
<b>18</b>	<b>Endodontic Forceps, Tissue Forceps, Haemostatic Forceps, Towel Clamps</b>	<b>  157-159  </b>	<b>██████████</b>
<b>19</b>	<b>Retractors, Lip &amp; Cheek Retractors, Hooks, Depressors &amp; Mouth Gags, Sterilizing Forceps</b>	<b>  160-164  </b>	<b>██████████</b>
<b>20</b>	<b>Orthodontic Pliers &amp; Cutters, Rongeurs</b>	<b>  165-179  </b>	<b>██████████</b>
<b>21</b>	<b>Needle Holders, Scissors, Micro Surgery Set</b>	<b>  180-186  </b>	<b>██████████</b>
<b>22</b>	<b>Impression Trays</b>	<b>  187-193  </b>	<b>██████████</b>
<b>23</b>	<b>Articulators, Hollow Wares</b>	<b>  194-200  </b>	<b>██████████</b>
<b>24</b>	<b>Scissors, Dissecting Forceps, Needle Holders, Wire Cutting Pliers With Tungsten Carbide Inserts</b>	<b>  201-213  </b>	<b>██████████</b>
<b>25</b>	<b>Dental Implants Instruments</b>	<b>  214-216  </b>	<b>██████████</b>
<b>26</b>	<b>Dental Instruments Sets</b>	<b>  217  </b>	<b>██████████</b>



⟨☞⟩ Extracting Forceps

⟨☞⟩ Root Elevators



# 01

SECTION







**1001**  
Fig. 4  
lower incisor



**1001**  
Fig. 4  
lower incisor



**1002**  
Fig. 8  
lower premolar



**1002**  
Fig. 8  
lower premolars



**1003**  
Fig. 1  
upper centrals & canines

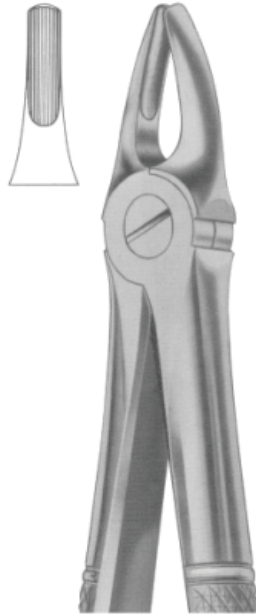

**1004**  
Fig. 2  
upper laterals & canines



**1005**  
Fig. 3  
upper incisors & canines



**1006**  
Fig. 4  
upper incisors & canines

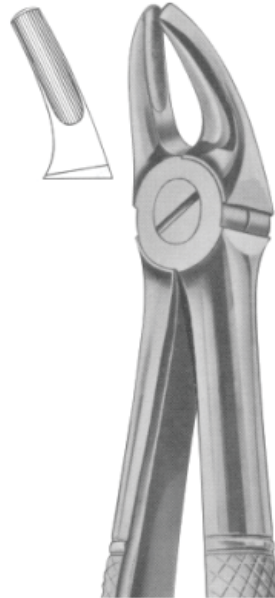

**1007**  
Fig. 7  
upper premolars

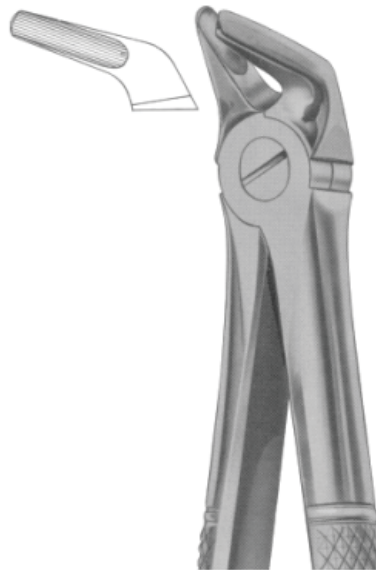

**1008**  
Fig. 8  
lower premolars

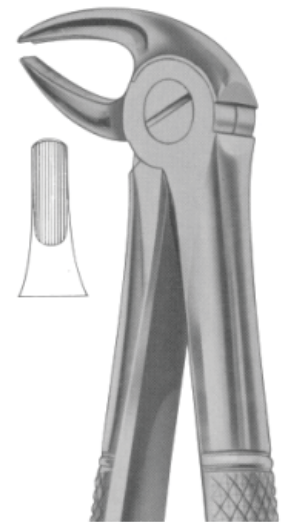

**1009**  
Fig. 13  
lower premolars



**1010**  
Fig. 13S  
lower premolars  
for children.

**1011**  
Fig. 17  
upper molars, right

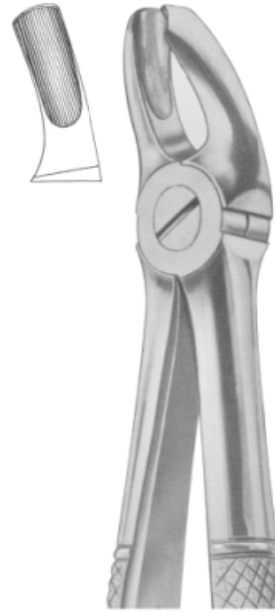

**1012**  
Fig. 18  
upper molars, left

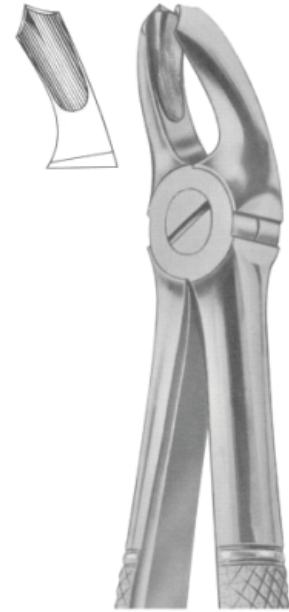

**1013**  
Fig. 18A  
upper molars

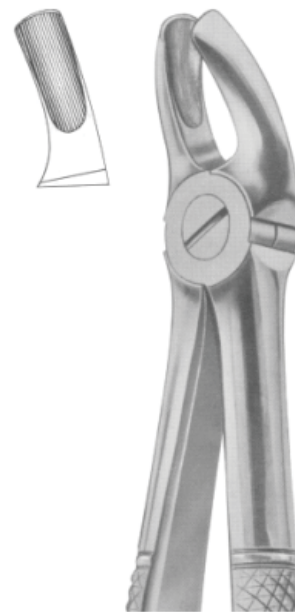

**1014**  
Fig. 18B  
upper molars

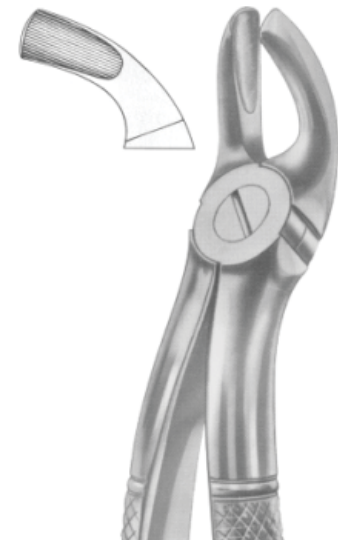

**1015**  
Fig. 19  
upper third molars



**1016**  
Fig. 20  
upper third molars

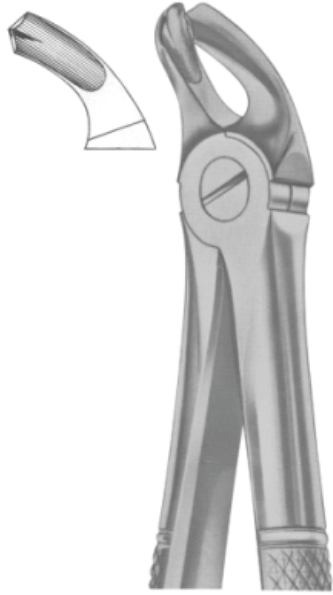

**1017**  
Fig. 21  
lower molars

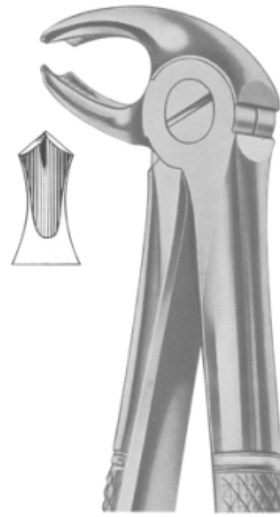

**1018**  
Fig. 22  
lower molars

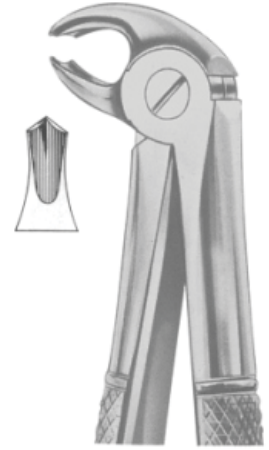

**1019**  
Fig. 22S  
lower molars  
for children

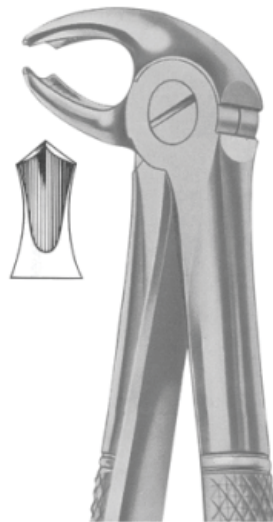

**1020**  
Fig. 22G  
lower molars

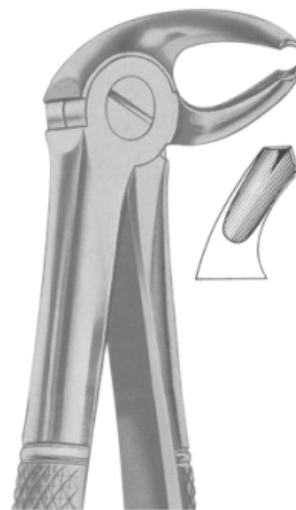

**1021**  
Fig. 23  
lower molars right

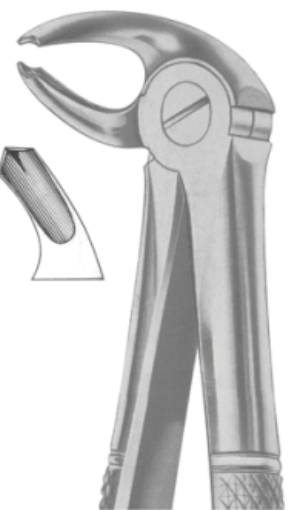

**1022**  
Fig. 24  
lower molars left



**1023**  
Fig. 29  
upper roots



**1024**  
Fig. 29S  
upper roots for children



**1025**  
Fig. 30  
upper roots

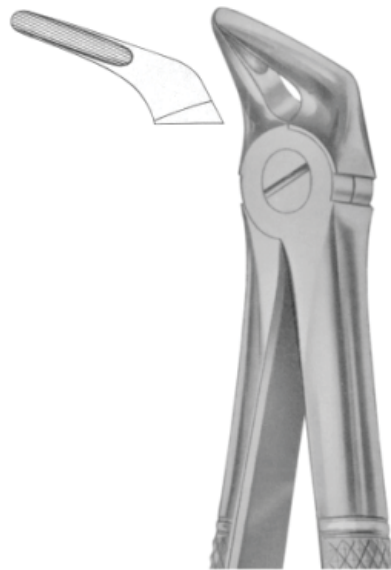

**1026**  
Fig. 31  
lower roots



**1027**  
Fig. 32  
lower molars



**1028**  
Fig. 30S  
upper roots  
for children



**1029**  
Fig. 33  
lower roots

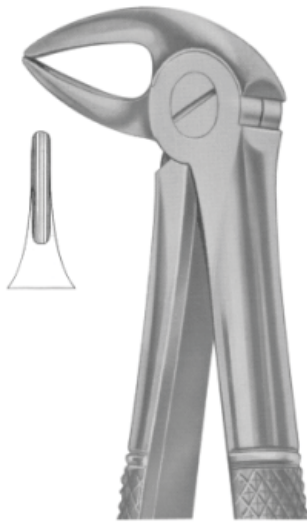

**1030**  
Fig. 33A  
lower roots

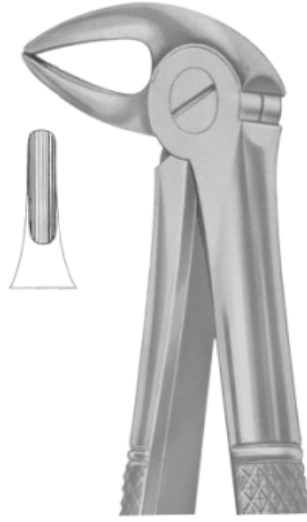

**1031**  
Fig. 33B  
lower roots

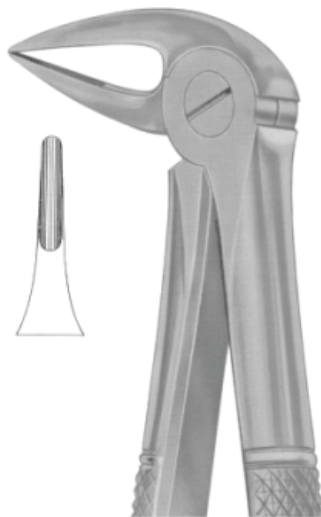

**1032**  
Fig. 33L  
lower roots



**1033**  
Fig. 37  
upper incisors  
for children



**1034**  
Fig. 33S  
lower roots  
for children



**1035**  
Fig. 38  
lower incisors &  
canines for children



**1036**  
Fig. 39  
upper molars  
for children



**1037**  
Fig. 39R  
upper molars right  
for children



**1040**  
Fig. 39L  
upper molars left  
for children



**1038**  
Fig. 39A  
upper molars  
for children

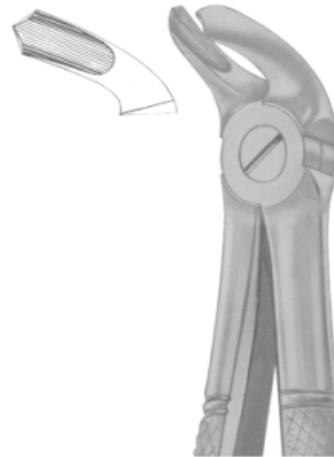

**1039**  
Fig. 40  
lower molars  
for children

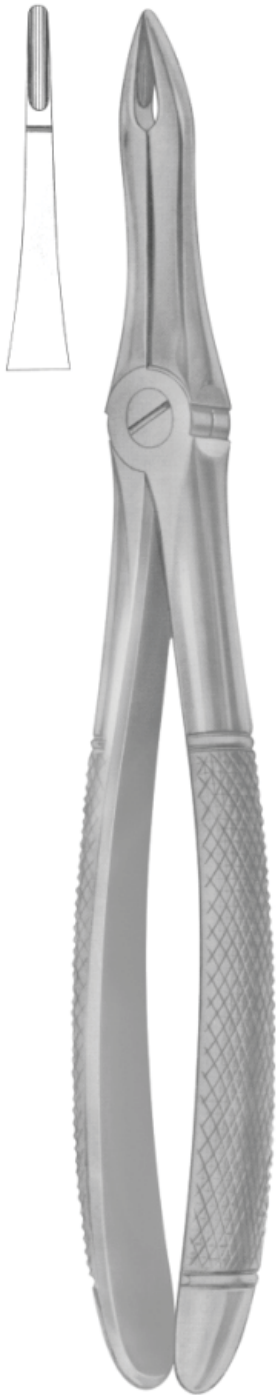

**1041**  
Fig. 41  
upper roots

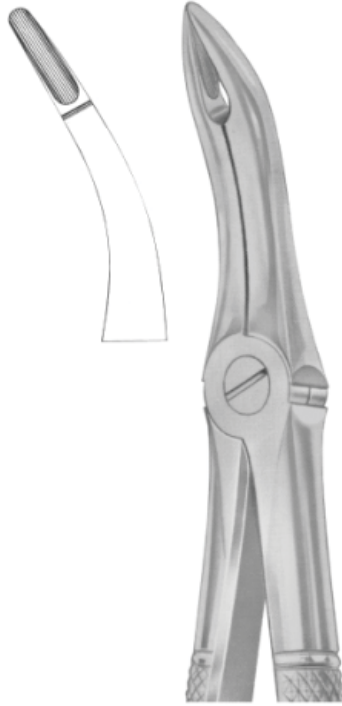

**1042**  
Fig. 44  
upper roots

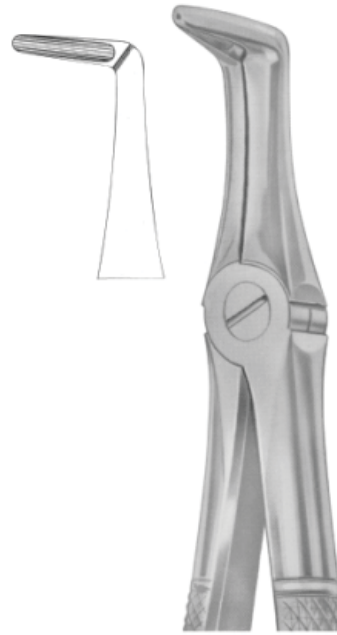

**1043**  
Fig. 45  
lower roots

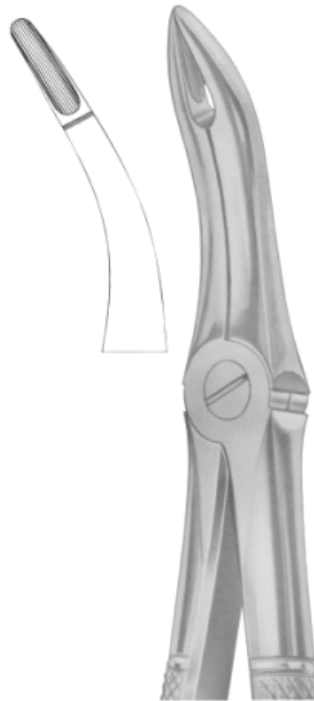

**1044**  
Fig. 48  
lower roots

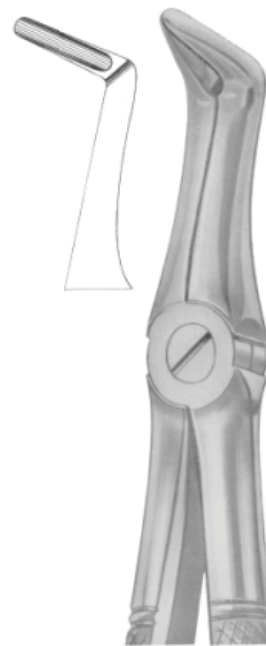

**1045**  
Fig. 49  
upper roots

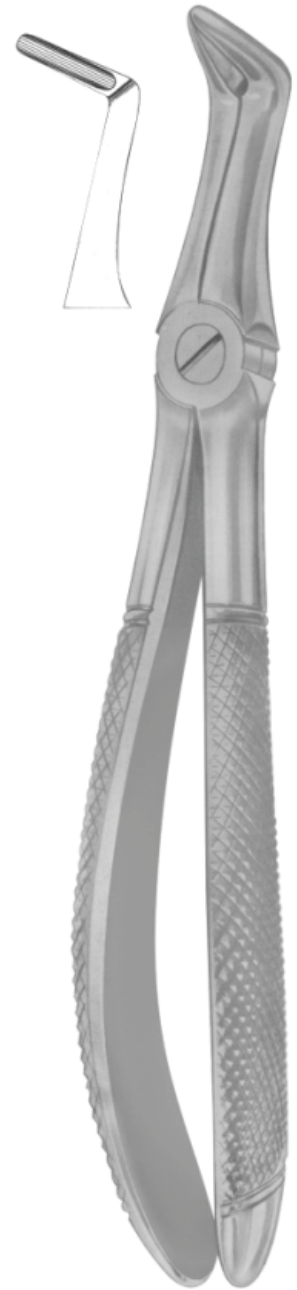

**1046**  
Fig. 50  
upper roots



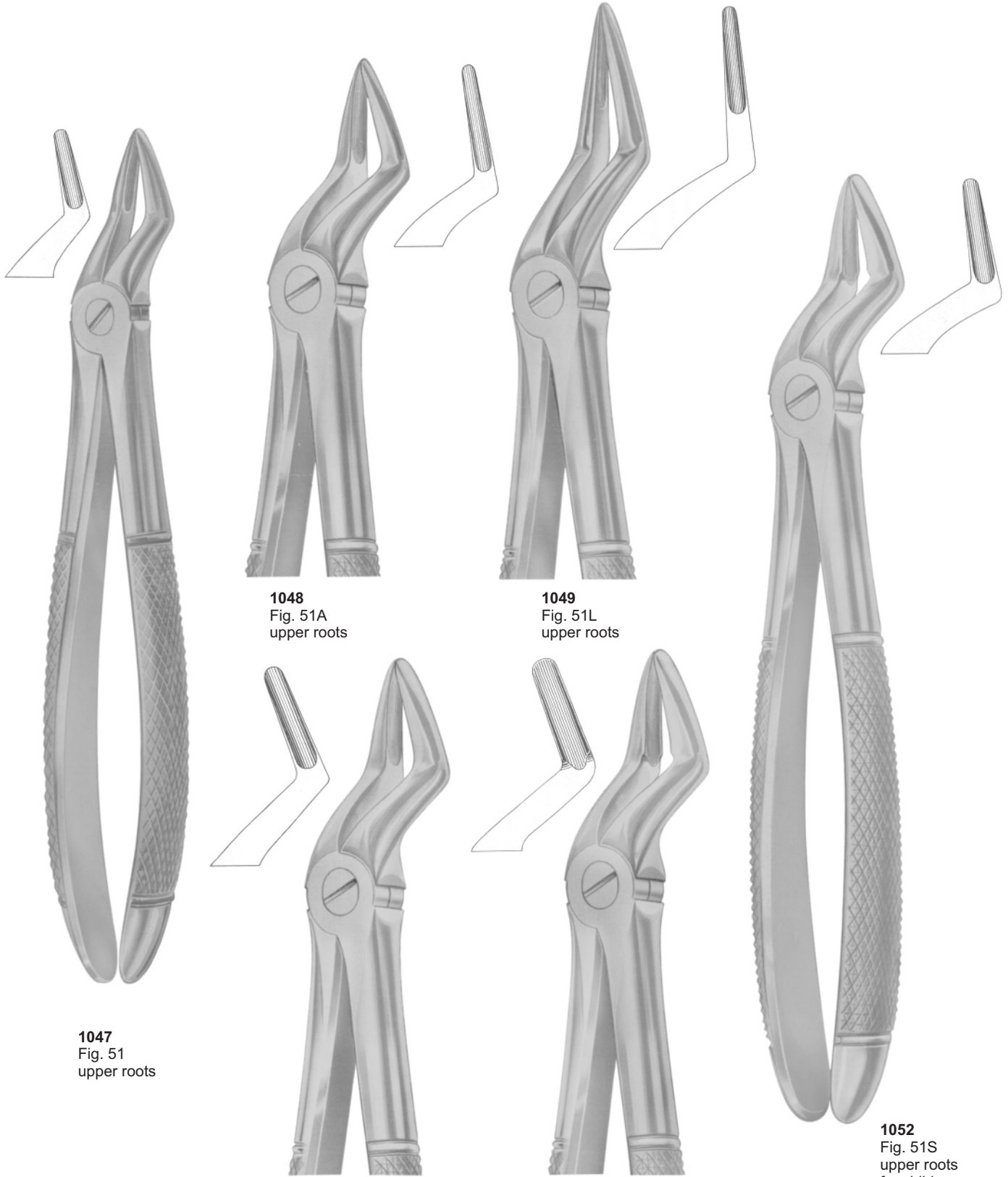

**1048**  
Fig. 51A  
upper roots

**1049**  
Fig. 51L  
upper roots

**1047**  
Fig. 51  
upper roots

**1050**  
Fig. 52  
upper roots

**1051**  
Fig. 52A  
upper teeth  
and resection

**1052**  
Fig. 51S  
upper roots  
for children



**1053**  
Fig. 54  
for separating  
upper molars



**1054**  
Fig. 55  
for separating  
upper molars



**1055**  
Fig. 56  
for separating  
lower molars

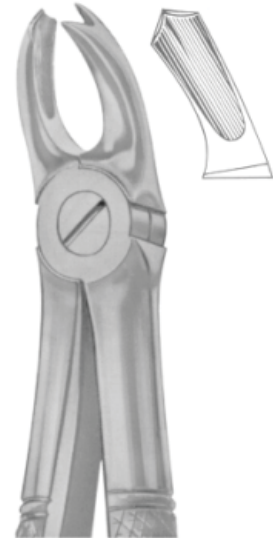

**1056**  
Fig. 65R  
upper molars  
right



**1057**  
Fig. 65L  
upper molars left



**1058**  
Fig. 67  
upper third molars

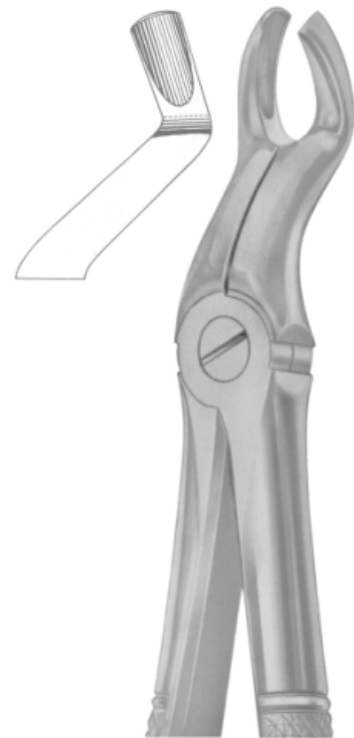

**1059**  
Fig. 67A  
upper third molars



**1060**  
Fig. 67 ½R  
upper third molars  
right



**1061**  
Fig. 67 ½L  
upper third molars  
left



**1062**  
Fig. 68  
lower roots



**1063**  
Fig. 68A  
lower roots



**1064**  
Fig. 73  
lower molars



**1065**  
Fig. 73R  
lower molars right



**1066**  
Fig. 73L  
lower molars left



**1067**  
Fig. 73A  
lower molars



**1068**  
Fig. 73S  
lower molars



**1069**  
Fig. 73B  
lower molars for children

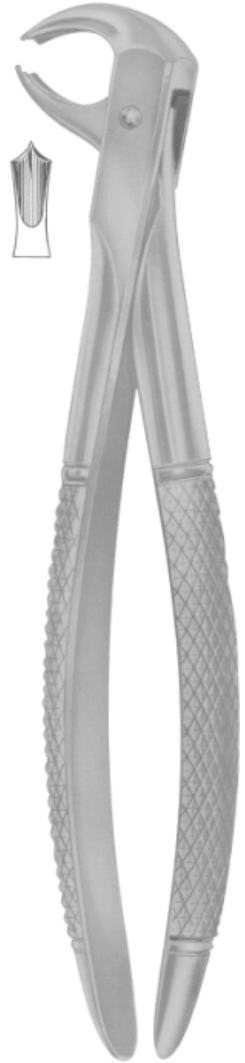

**1072**  
Fig. 73K  
lower molars  
for children



**1070**  
Fig. 74  
lower roots

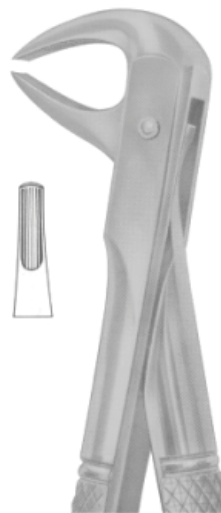

**1071**  
Fig. 74D  
lower roots

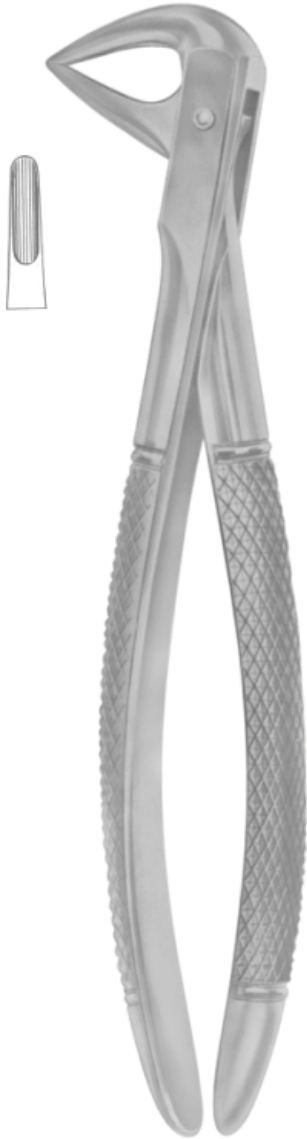

**1073**  
Fig. 74M  
lower roots



**1074**  
Fig. 74N  
lower roots



**1075**  
Fig. 74XN  
lower roots and  
crowded incisors



**1078**  
Fig. 76N  
upper roots

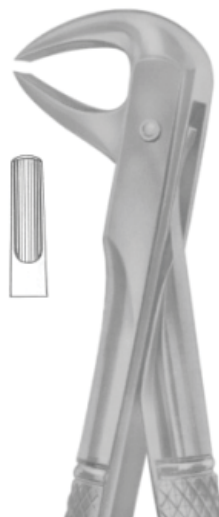

**1076**  
Fig. 75  
lower premolars



**1077**  
Fig. 76  
upper roots





**1079**  
Fig. 76S  
upper roots



**1080**  
Fig. 79  
lower third molars



**1081**  
Fig. 79A  
lower third molars



**1082**  
Fig. 81  
lower premolars  
and roots



**1083**  
Fig. 86A  
lower molars



**1084**  
Fig. 86B  
lower molars



**1085**  
Fig. 86C  
lower molars



**1086**  
Fig. 87  
lower molars



**1087**  
Fig. 91  
for separating  
lower molars

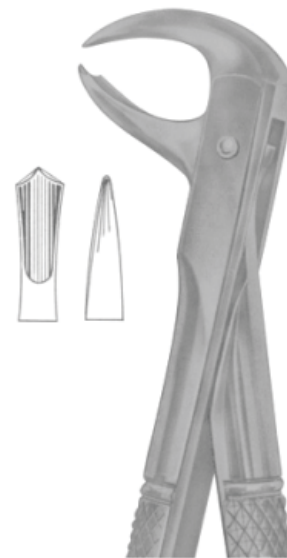

**1088**  
Fig. 99  
lower molars



**1089**  
Fig. 101  
upper premolars  
and roots

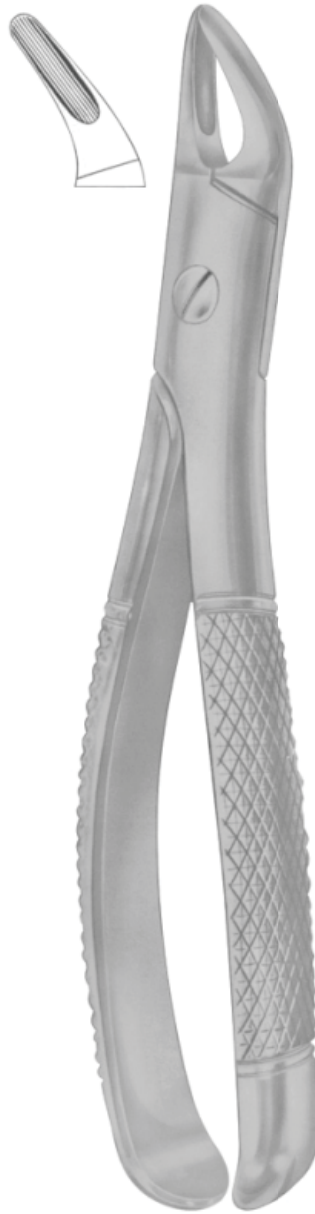

**1090**  
Fig. 100  
upper roots



**1091**  
Fig. 99 1/4  
lower molars



**1092**  
Fig. 99 1/2  
lower molars







**1093**  
Fig. 102  
upper molars right



**1094**  
Fig. 103  
upper molars left



**1095**  
Fig. 105  
lower incisors



**1096**  
Fig. 106  
lower incisors



**1097**  
Fig. 103  
upper canines

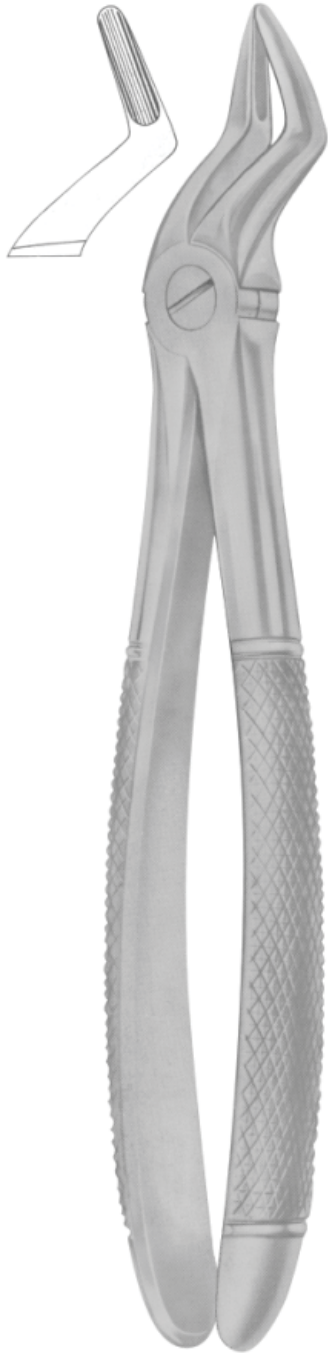

**1098**  
Fig. 112  
upper roots

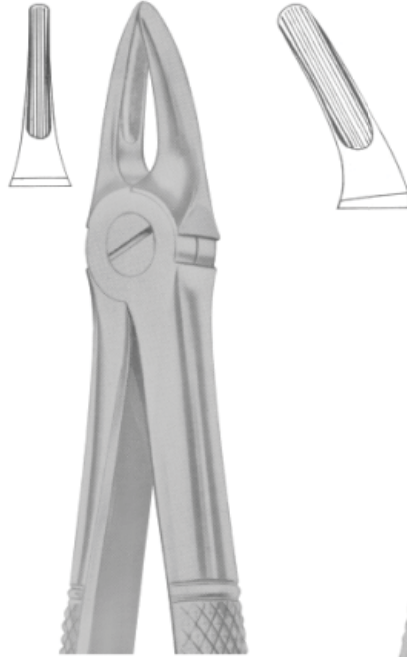

**1099**  
Fig. 113  
upper roots



**1101**  
Fig. 136  
upper premolars  
and roots

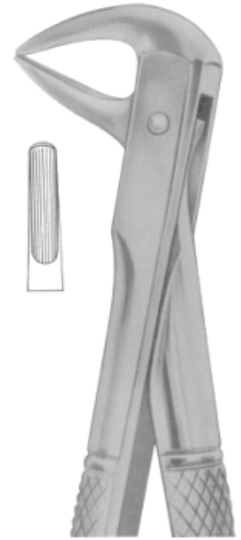

**1102**  
Fig. 137  
lower incisors  
and roots

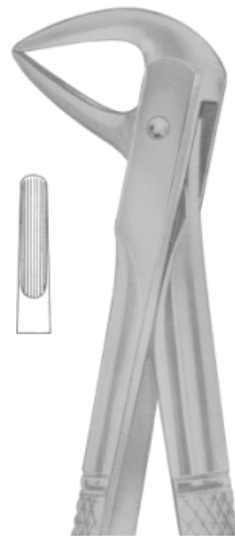

**1100**  
Fig. 114  
upper roots



**1103**  
Fig. 143  
lower roots



**1104**  
MEAD (MD 1)  
upper anteriors,  
roots, incisors, canines

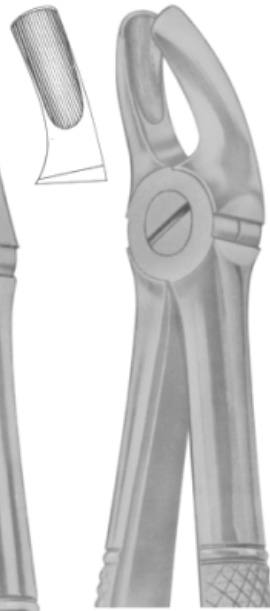

**1105**  
MEAD (MD 2)  
upper molars



**1108**  
FELSCH (Fig. 210)  
upper third molars

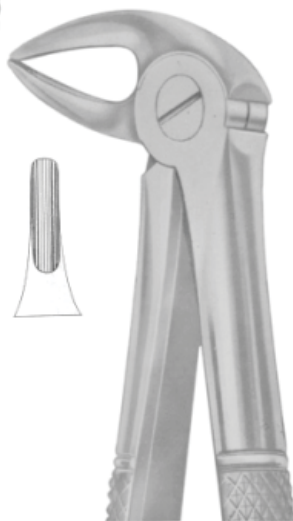

**1106**  
MEAD (MD 3)  
lower roots



**1107**  
MEAD (MD 4)  
lower molars



**1109**  
HERTZ (Fig. 211)  
lower incisors





**1110**  
ROUTURIER (Fig. 212)  
( 22 ½ L )  
lower molars  
and wisdom left



**1111**  
ROUTURIER (Fig. 213)  
( 22 ½ R )  
lower molars  
and wisdom right



**1112**  
ROUTURIER (Fig. 214)  
( 22 ½ L )  
lower molars  
and wisdom left



**1113**  
ROUTURIER (Fig. 215)  
( 33 ½ R )  
lower molars  
and wisdom right

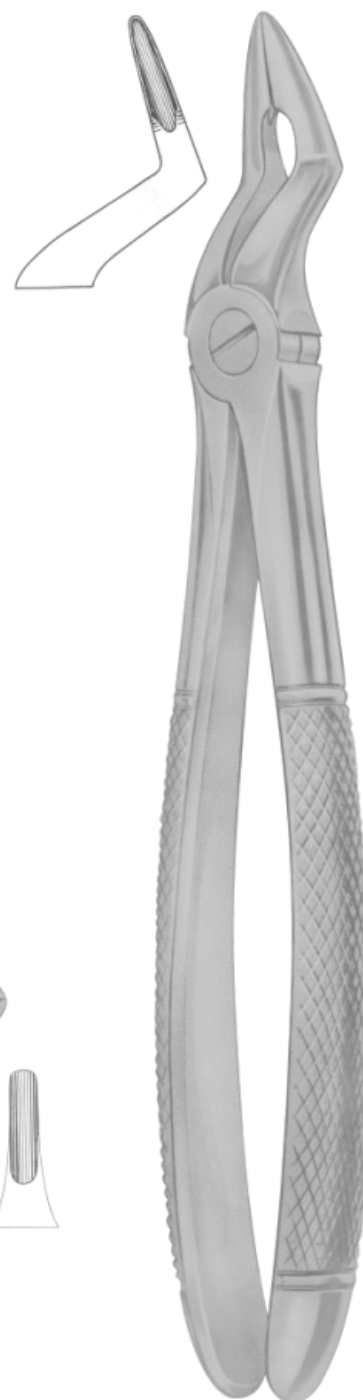

**1114**  
RESECTION FORCEPS  
( 216/Witzel )  
upper roots



**1115**  
Fig. 5



**1116**  
Fig. 6



**1117**  
Fig. 9



**1118**  
Fig. 10



**1119**  
Fig. 11



**1120**  
Fig. 12



**1121**  
Fig. 14



**1122**  
Fig. 15



**1123**  
Fig. 25



**1124**  
Fig. 26



**1125**  
Fig. 27



**1126**  
Fig. 28



**1127**  
Fig. 34



**1128**  
Fig. 35



**1129**  
Fig. 42



**1130**  
Fig. 43



**1131**  
Fig. 44A



**1132**  
Fig. 46



**1133**  
Fig. 47



**1134**  
Fig. 50A



**1135**  
Fig. 74R



**1136**  
Fig. 74L



**1137**  
Fig. 75R



**1138**  
Fig. 75L



1139  
Fig. 94



1140  
Fig. 95



1141  
Fig. 98



1142  
Fig. 105



1143  
Fig. 106



1144  
Fig. 2002





**1145**  
Fig. 1  
upper laterals  
and canines

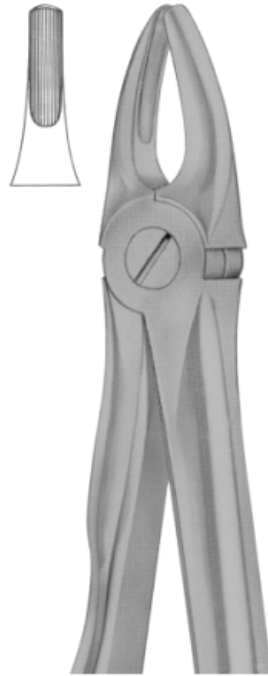

**1146**  
Fig. 2  
upper laterals  
and canines

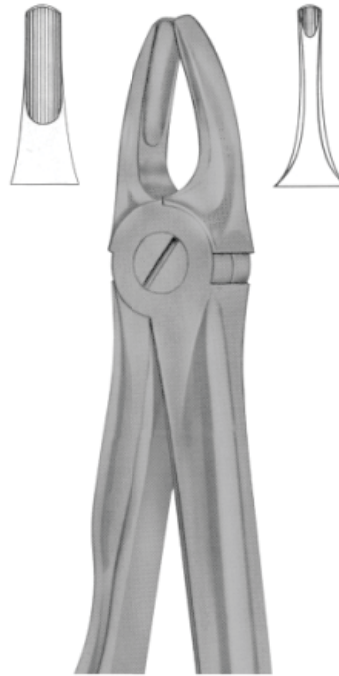

**1147**  
Fig. 3  
upper incisors  
and canines

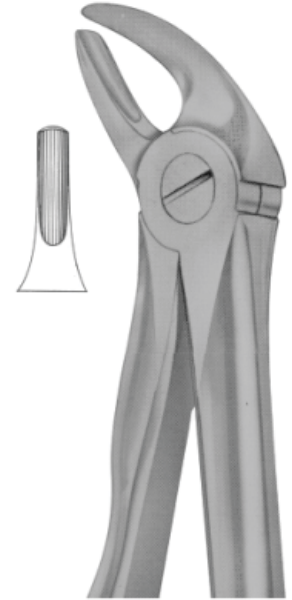

**1148**  
Fig. 4  
lower incisors  
and canines

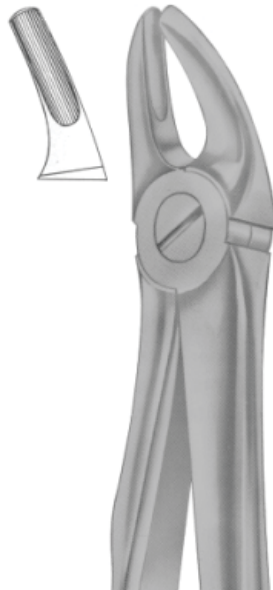

**1149**  
Fig. 7  
upper premolars

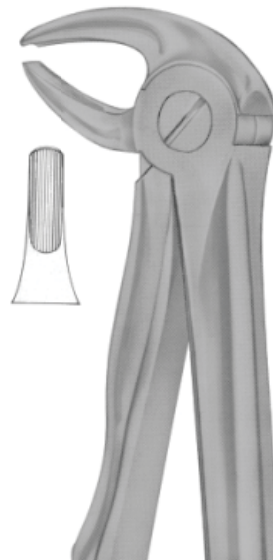

**1150**  
Fig. 13  
lower premolars



**1151**  
Fig. 13S  
lower premolars  
for children



**1152**  
Fig. 17  
upper molars right



**1153**  
Fig. 18  
upper molars left



**1154**  
Fig. 18A  
upper molars

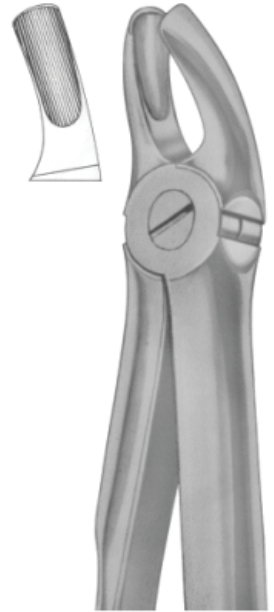

**1155**  
Fig. 18B  
upper molars

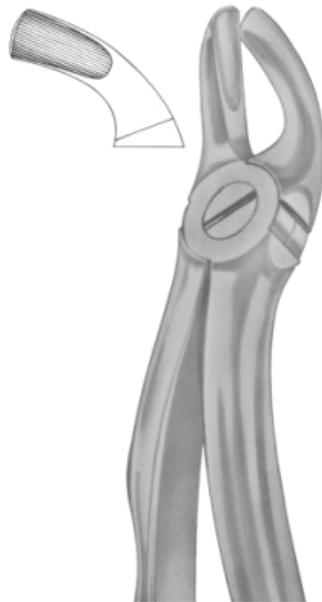

**1156**  
Fig. 19  
upper third molars

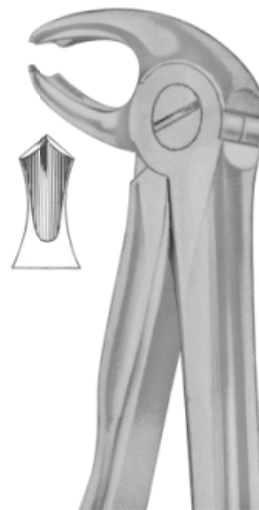

**1157**  
Fig. 22  
lower molars



**1158**  
Fig. 22S  
lower molars  
for children



**1159**  
Fig. 29  
upper roots



**1160**  
Fig. 29S  
upper roots  
for children

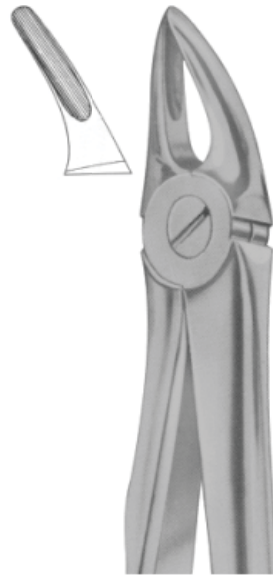

**1161**  
Fig. 30  
upper roots

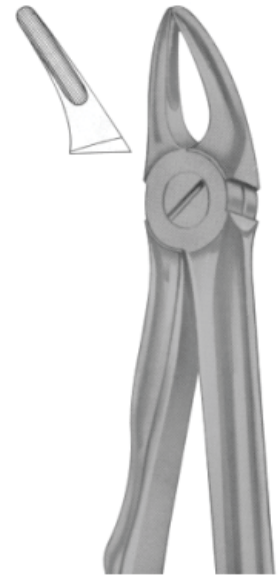

**1162**  
Fig. 30S  
upper roots  
for children

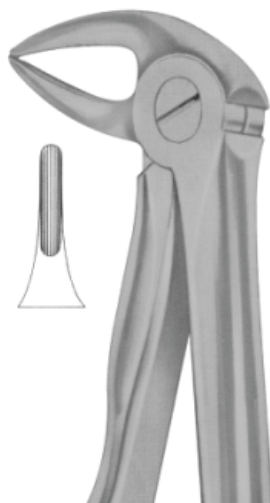

**1163**  
Fig. 33  
lower roots



**1164**  
Fig. 33A  
lower roots

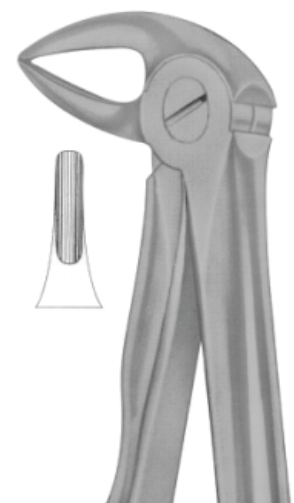

**1165**  
Fig. 33B  
lower roots



**1166**  
Fig. 33L  
lower roots



**1167**  
Fig. 33S  
lower roots  
for children



**1168**  
Fig. 37  
upper incisors  
for children



**1169**  
Fig. 39  
upper incisors  
for children



**1170**  
Fig. 39A  
upper molars  
for children



**1171**  
Fig. 39R  
upper molars right  
for children

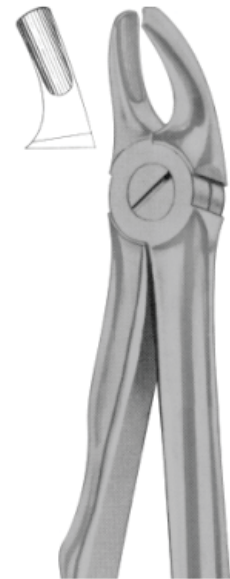

**1172**  
Fig. 39L  
upper molars left  
for children



**1173**  
Fig. 41  
upper roots

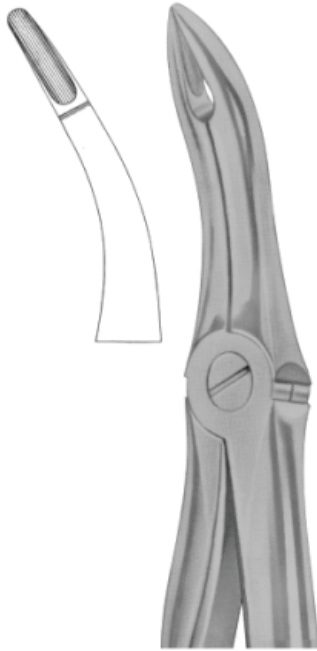

**1174**  
Fig. 44  
upper roots

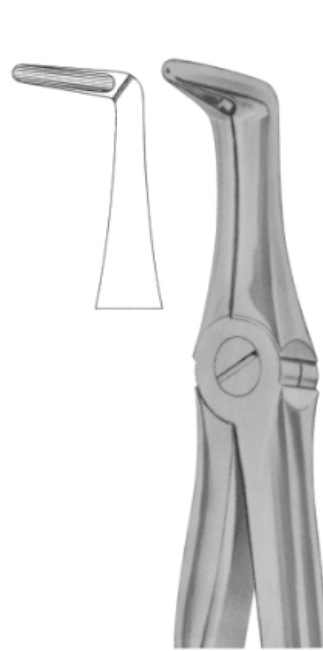

**1175**  
Fig. 45  
lower roots

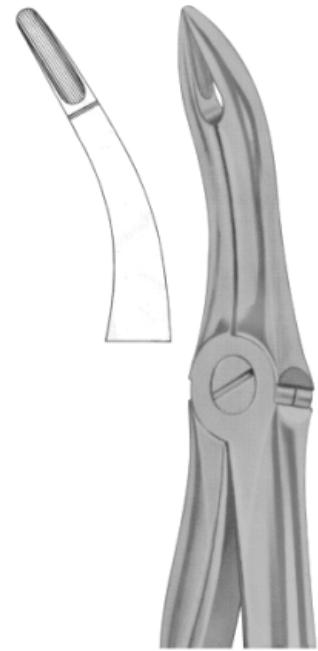

**1176**  
Fig. 48  
lower roots

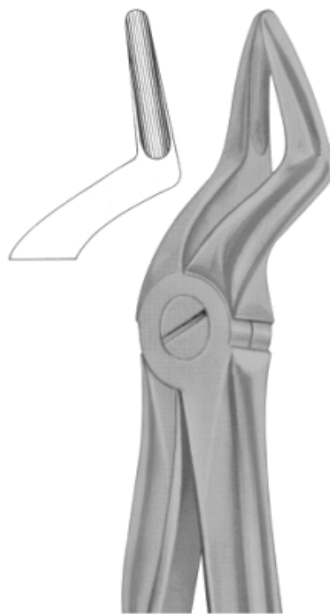

**1177**  
Fig. 51  
upper roots

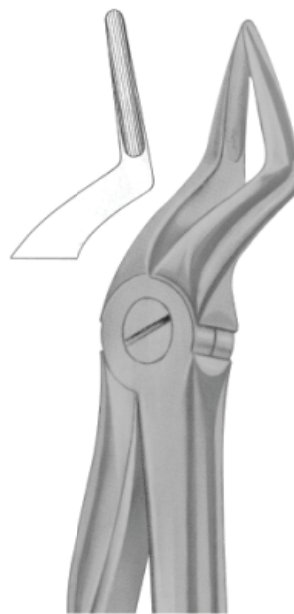

**1178**  
Fig. 51A  
upper roots

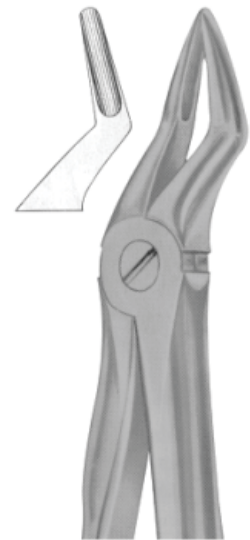

**1179**  
Fig. 51S  
upper roots  
for children



**1180**  
Fig. 51L  
upper roots

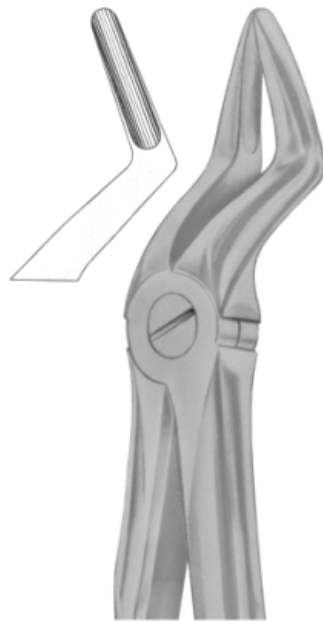

**1181**  
Fig. 52  
upper roots

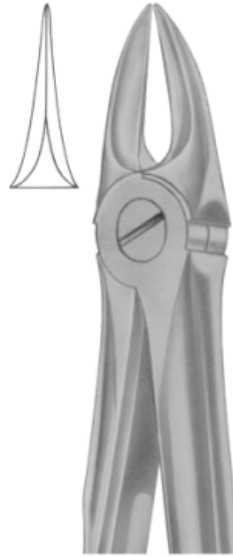

**1182**  
Fig. 54  
for separating  
upper molars

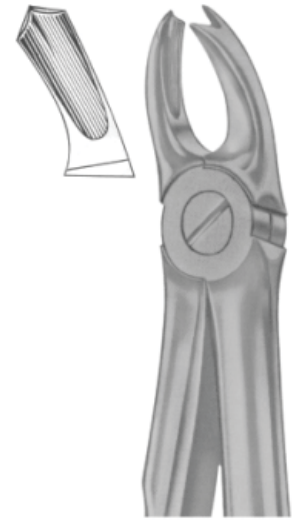

**1183**  
Fig. 65R  
upper molars right

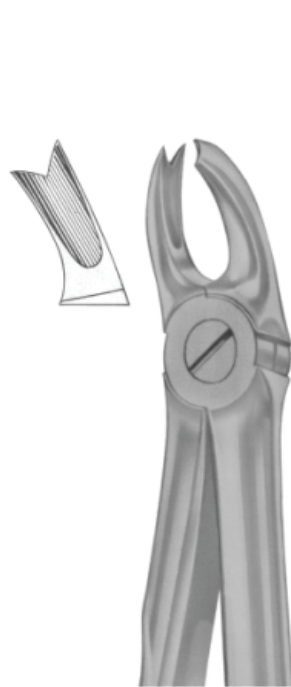

**1184**  
Fig. 65L  
upper molars left



**1185**  
Fig. 67  
upper third molars

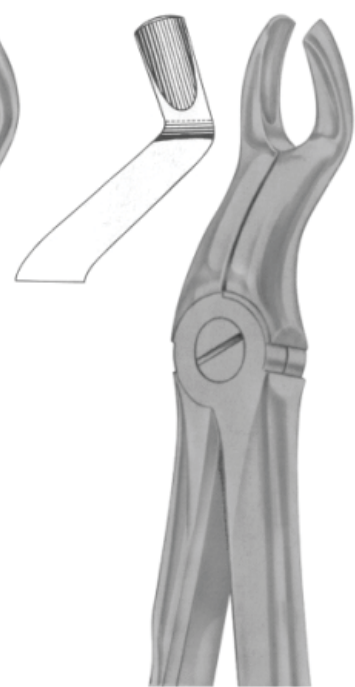

**1186**  
Fig. 67A  
upper third molars



**1187**  
Fig. 67 ½ R  
upper third molars  
right

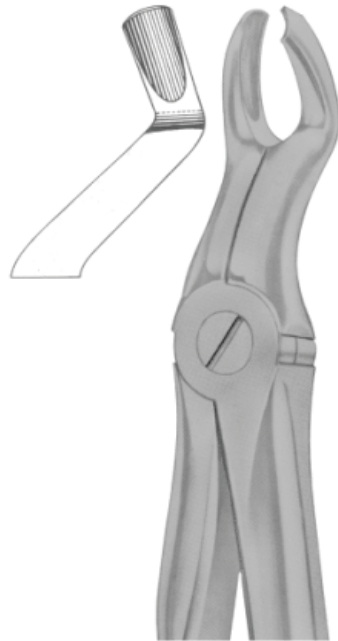

**1188**  
Fig. 67 ½ L  
upper third molars  
left



**1189**  
Fig. 73  
lower molars



**1190**  
Fig. 74  
lower roots

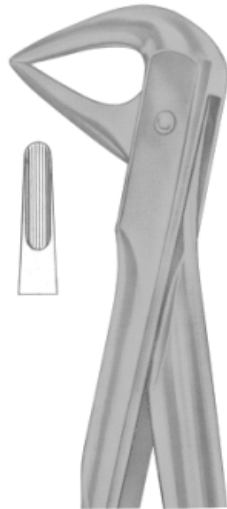

**1191**  
Fig. 74M  
lower roots



**1192**  
Fig. 74N  
lower roots



**1193**  
Fig. 74XN  
lower roots and  
crowded incisors



**1194**  
Fig. 75  
lower premolars



**1195**  
Fig. 76  
upper roots



**1196**  
Fig. 76N  
upper roots



**1197**  
Fig. 81  
lower premolars  
and roots



**1198**  
Fig. 76A  
lower third molars



**1199**  
Fig. 79  
lower third molars





**1200**  
Fig. 86A  
lower molars



**1201**  
Fig. 86B  
lower molars



**1202**  
Fig. 86C  
lower molars

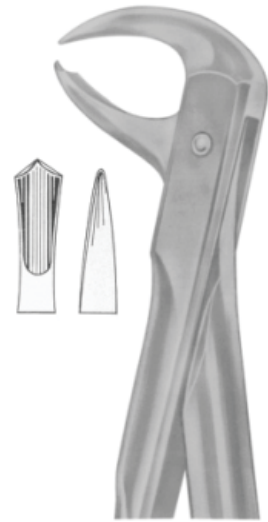

**1203**  
Fig. 99  
lower molars



**1204**  
Fig. 99 1/4  
lower molars

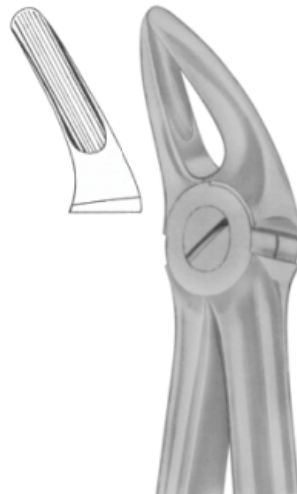

**1205**  
Fig. 136  
upper premolars  
and roots



**1206**  
Fig. 143  
lower roots



**1207**  
KLEIN (Fig. 217)  
upper incisors



**1208**  
KLEIN (Fig. 218)  
upper premolars



**1209**  
KLEIN (Fig. 219)  
upper roots

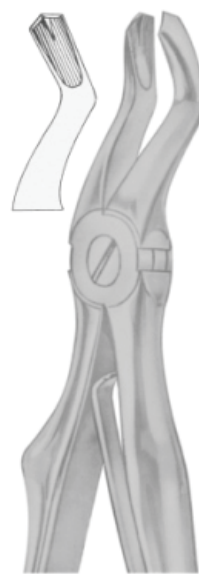

**1210**  
KLEIN (Fig. 220)  
upper molars



**1214**  
ALBRECHT  
Fig. 224  
Deciduous



**1215**  
ALBRECHT  
Fig. 225  
Deciduous



**1211**  
KLEIN (Fig. 221)  
lower incisors



**1212**  
KLEIN (Fig. 222)  
lower molars



**1213**  
KLEIN (Fig. 223)  
lower roots

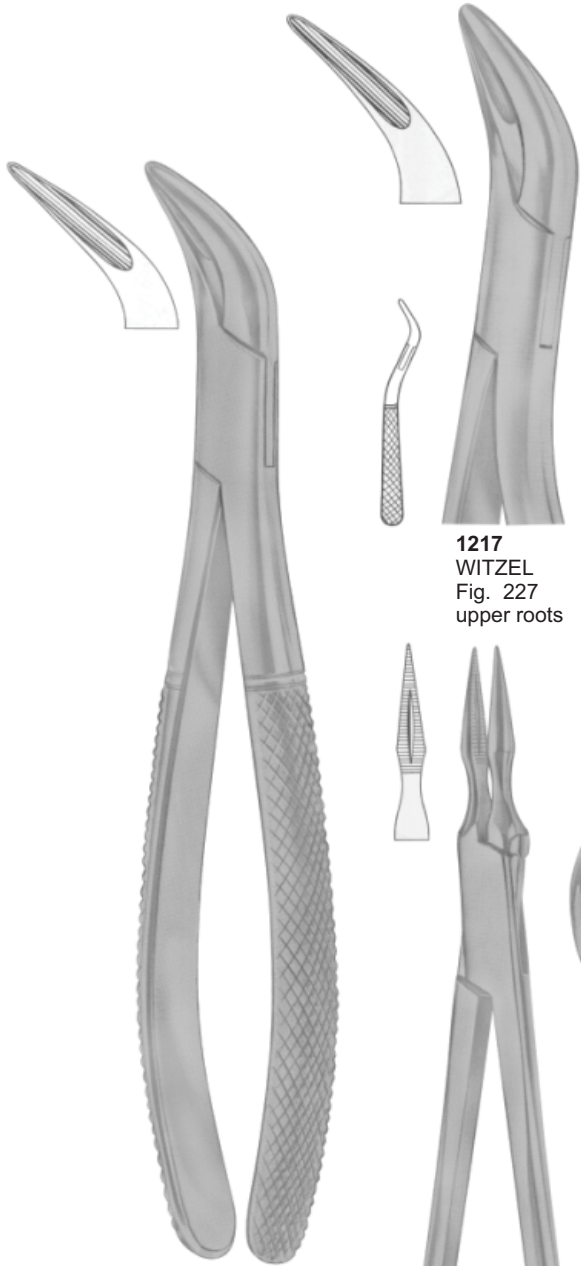

**1216**  
WITZEL  
Fig. 226  
lower roots



**1217**  
WITZEL  
Fig. 227  
upper roots



**1218**  
ARTHUR  
Fig. 228  
root fragments

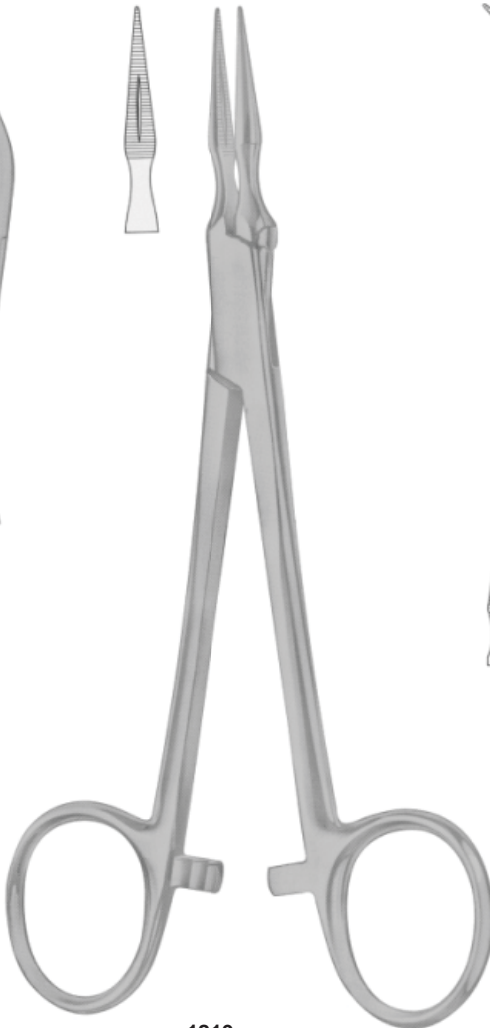

**1219**  
STIEGLITZ  
Fig. 229  
root fragments

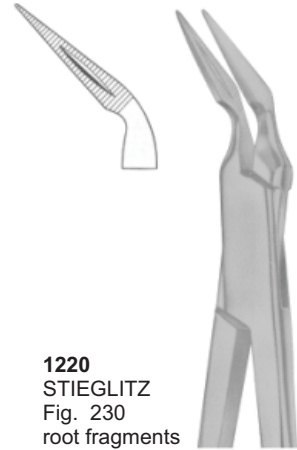

**1220**  
STIEGLITZ  
Fig. 230  
root fragments



**1221**  
RALK  
Fig. 231  
root fragments



**1222**  
W1-WINTER  
upper centrals  
and canines



**1223**  
Fig. 1  
upper incisors and roots

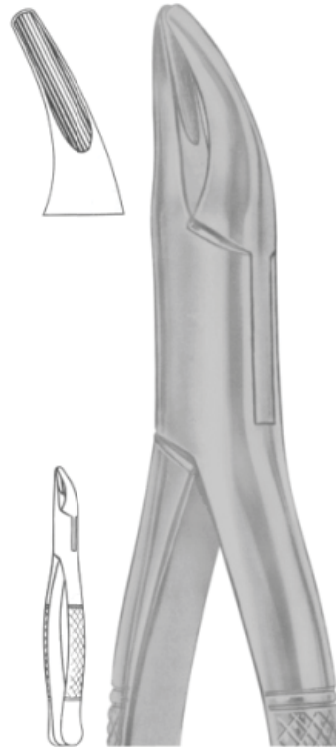

**1224**  
Fig. 2  
upper and lower roots

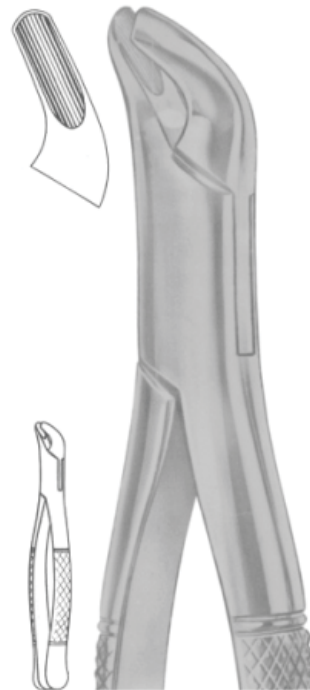

**1225**  
Fig. 4  
upper and lower premolars



**1226**  
PHYSICK  
Fig. 5  
lower third molars



**1227**  
Fig. 6  
separating  
forceps



**1228**  
Fig. 7  
upper roots

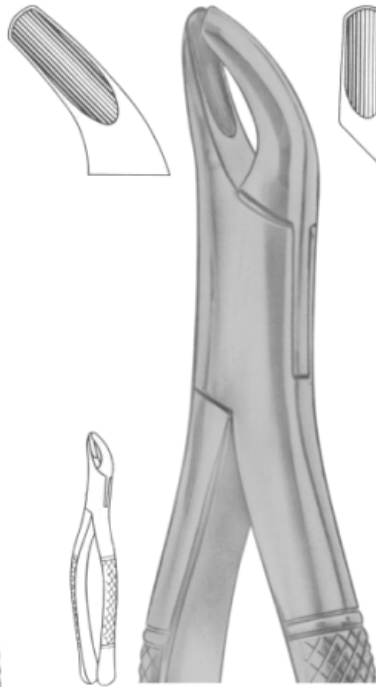

**1229**  
Fig. 8  
upper and lower  
third molars

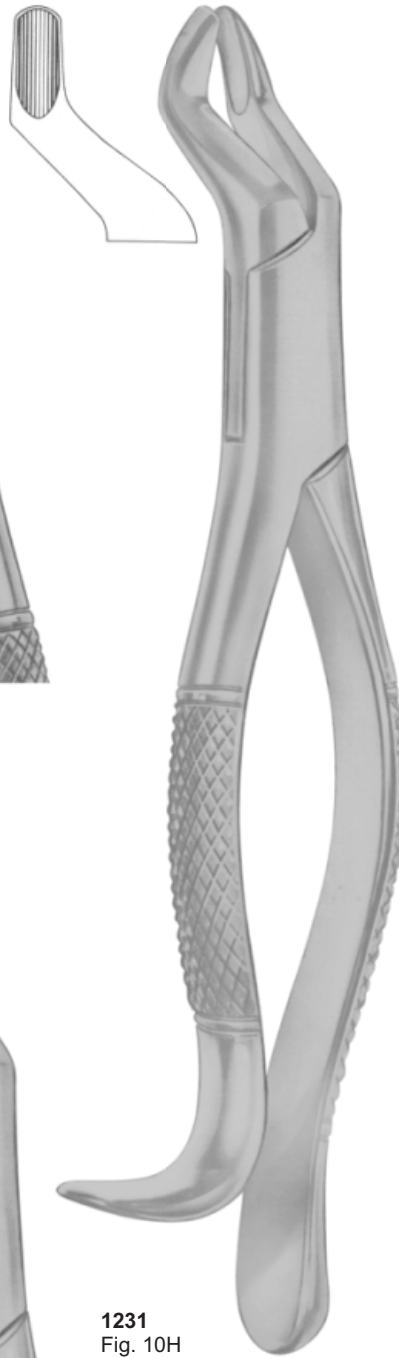

**1231**  
Fig. 10H  
upper molars



**1232**  
Fig. 13  
upper incisors

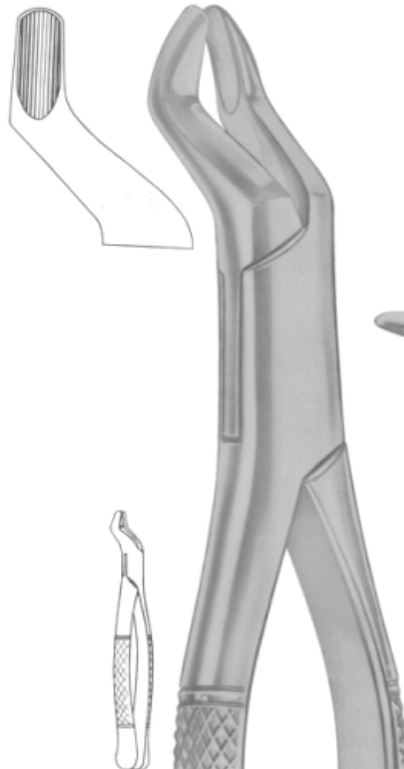

**1230**  
Fig. 10S  
upper molars



**1233**  
Fig. 14  
lower incisors



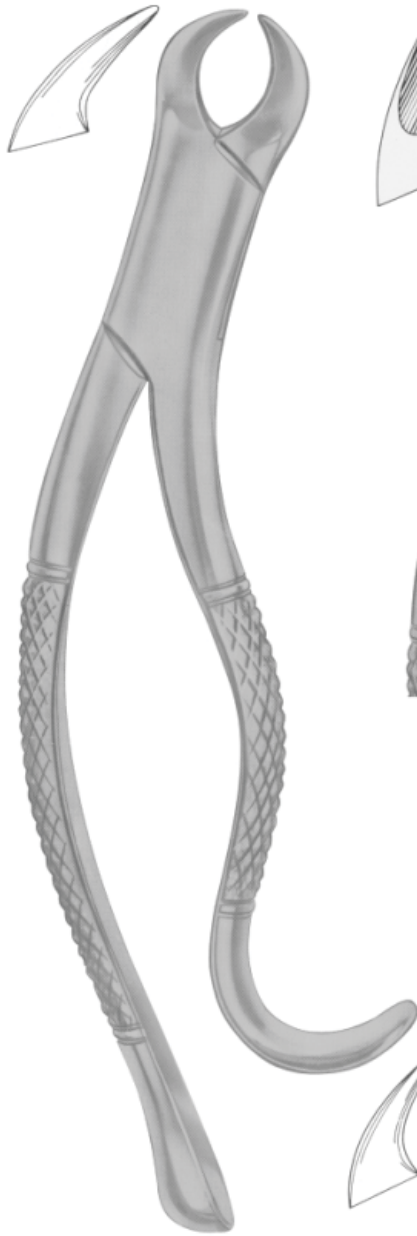

**1234**  
Fig. 16  
lower molars



**1235**  
HARRIS  
Fig. 15  
lower molars

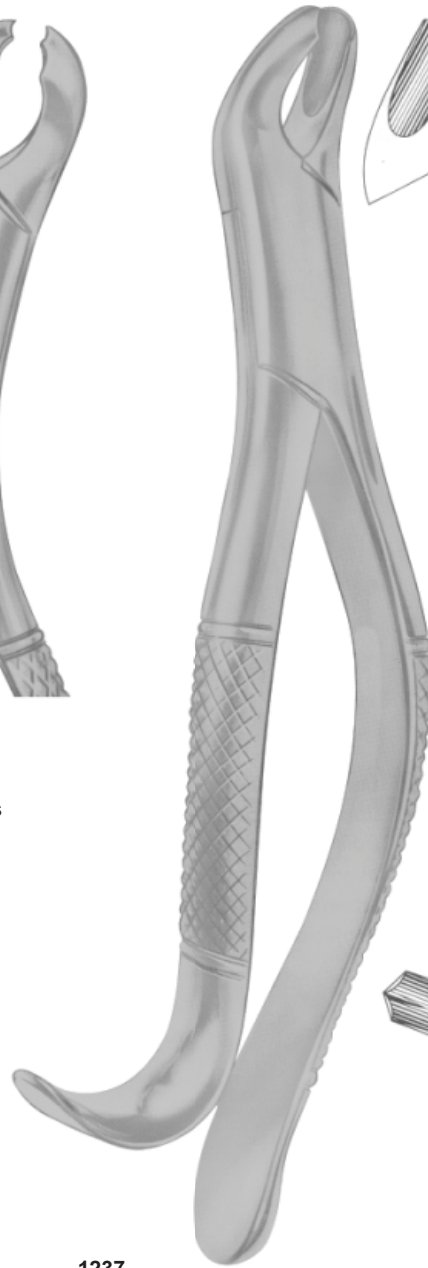

**1237**  
HARRIS  
Fig. 18R  
upper molars right



**1238**  
HARRIS  
Fig. 18L  
upper molars left



**1236**  
Fig. 16S  
lower molars  
for children

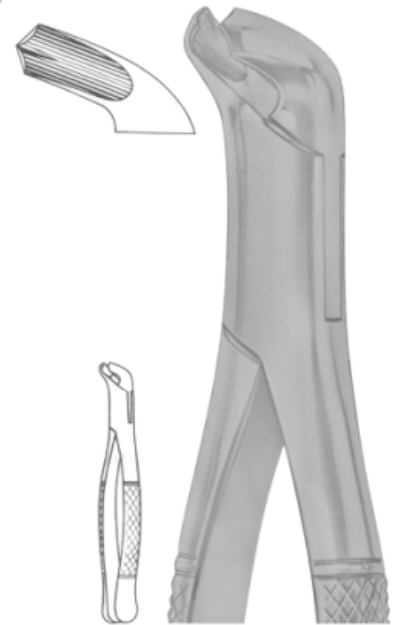

**1239**  
Fig. 17  
lower molars

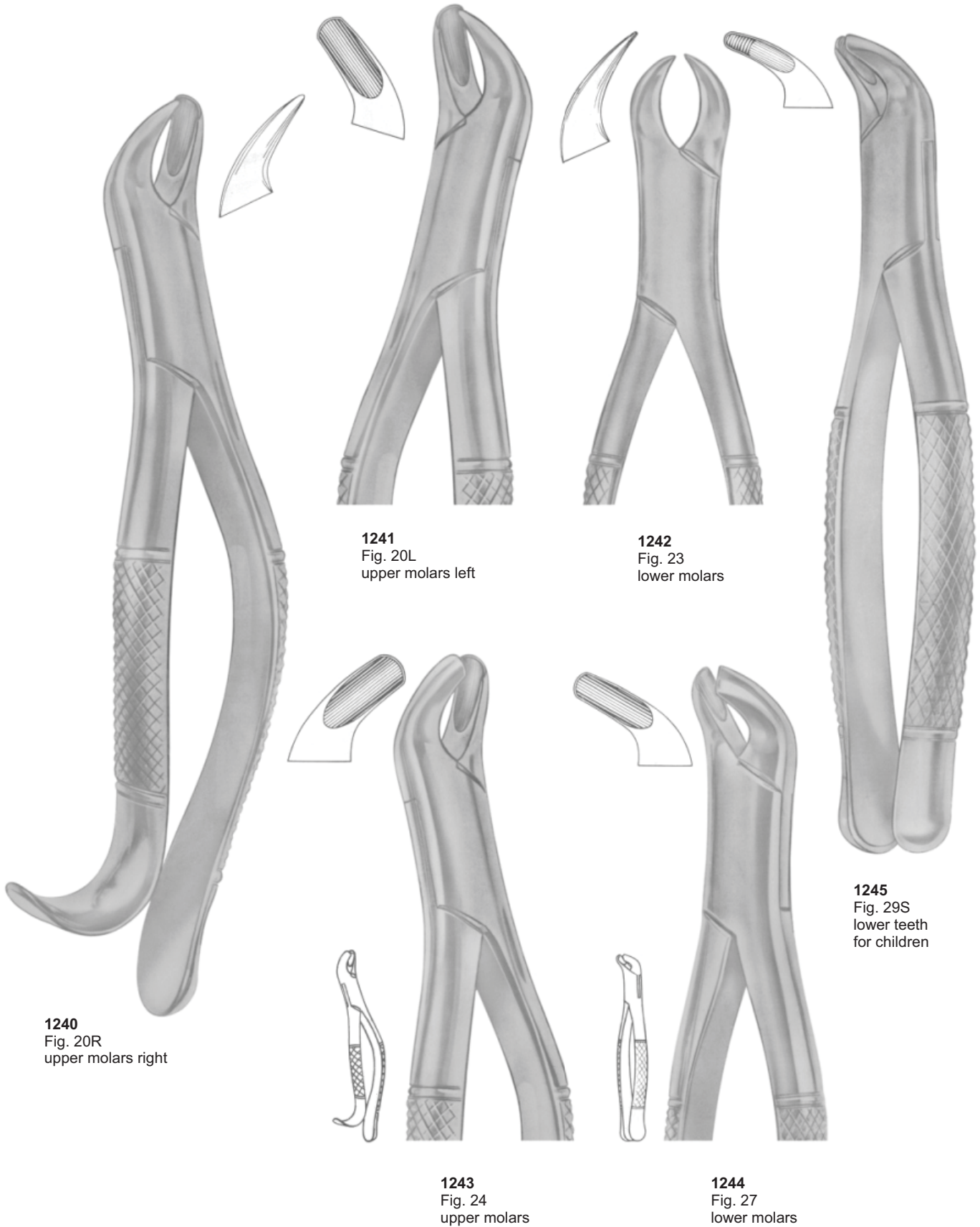



**1246**  
Fig. 30S  
upper teeth  
for children

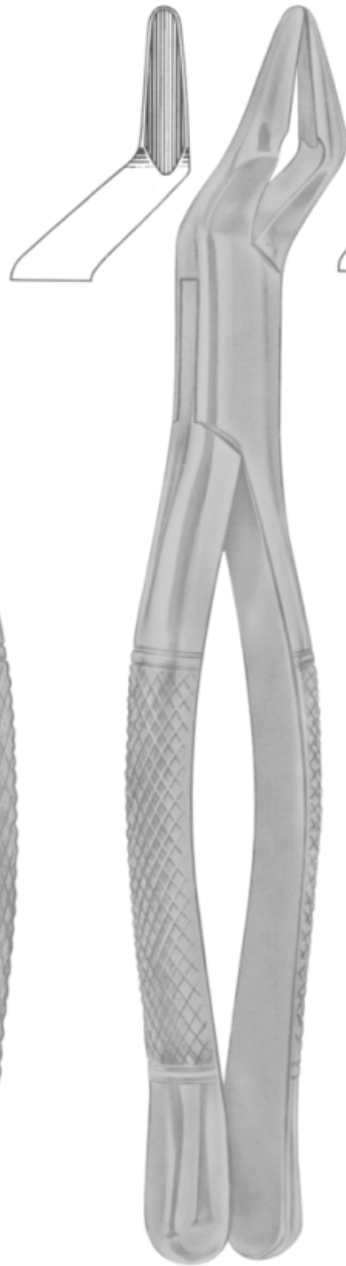

**1247**  
PARMLY  
Fig. 32  
upper premolars  
and molars



**1248**  
PARMLY  
Fig. 32A  
upper premolars  
and roots



**1249**  
Fig. 34  
lower anteriors  
and roots

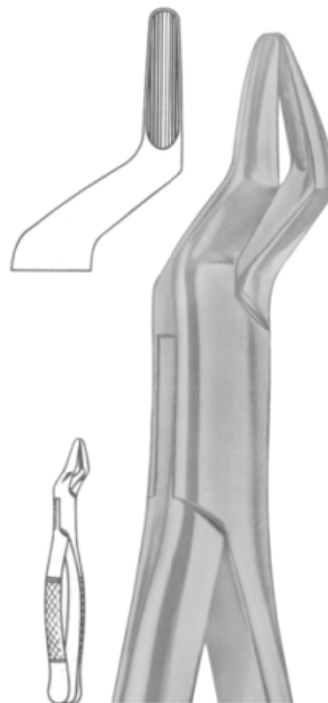

**1250**  
Fig. 35  
upper roots



**1251**  
Fig. 36  
lower anteriors  
and roots





**1252**  
Fig. 37  
lower anteriors  
and roots

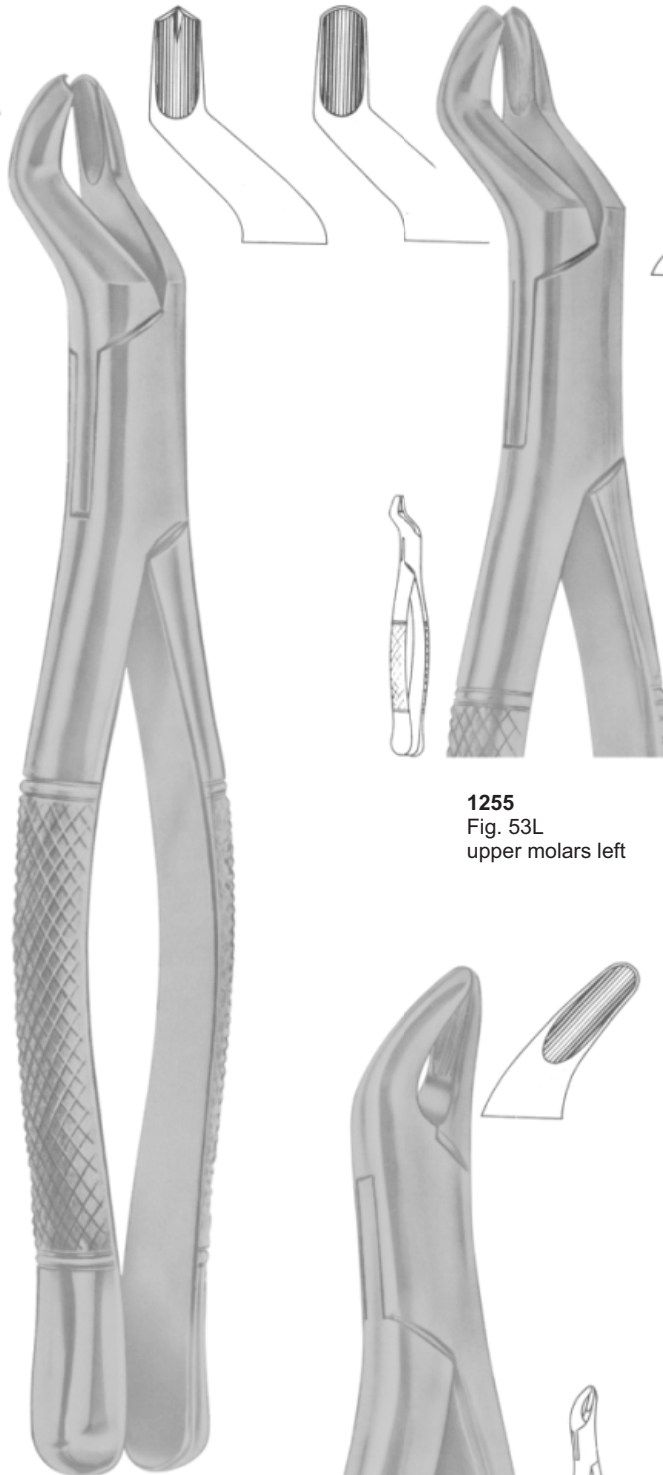

**1254**  
Fig. 53R  
upper molars right



**1255**  
Fig. 53L  
upper molars left

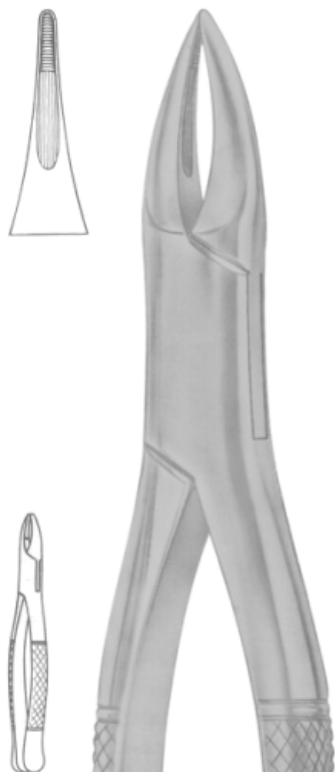

**1253**  
Fig. 38  
upper anteriors  
and roots



**1256**  
Fig. 62  
incisors, premolars,  
deciduous teeth

**1257**  
Fig. 65  
upper incisors  
and roots



**1258**  
TOMEs  
Fig. 69  
upper and lower roots



**1259**  
TOMEs  
Fig. 85  
lower canines,  
premolars and molars



**1260**  
NEVIUS  
Fig. 88R  
upper molars right



**1261**  
THOMAS  
Fig. 85A  
lower canines,  
premolars and molars



**1262**  
NEVIUS  
Fig. 88L  
upper molars left



**1263**  
KELLS  
Fig. 99A  
upper incisors,  
canines, premolars



**1264**  
Fig. 104  
upper third molars



**1266**  
HULL  
Fig. 101  
deciduous teeth



**1267**  
Fig. 103  
lower incisors,  
premolars



**1265**  
KELLS  
Fig. 99C  
upper incisors,  
canines, premolars



**1268**  
CRYER  
Fig. 150  
lower incisors,  
premolars, roots



**1269**  
CRYER  
Fig. 150A  
upper incisors,  
premolars, roots

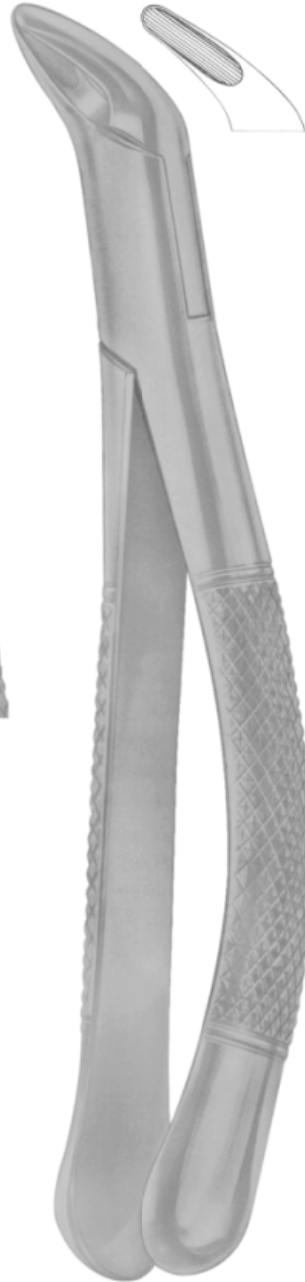

**1271**  
CRYER  
Fig. 151  
lower incisors,  
premolars, roots



**1272**  
CRYER  
Fig. 151A  
lower incisors,  
premolars, roots



**1270**  
CRYER  
Fig. 150S  
upper teeth for children



**1273**  
CRYER  
Fig. 151S  
lower teeth  
for children



**1274**  
Fig. 203  
lower incisors  
and roots



**1275**  
Fig. 210S  
upper third molars

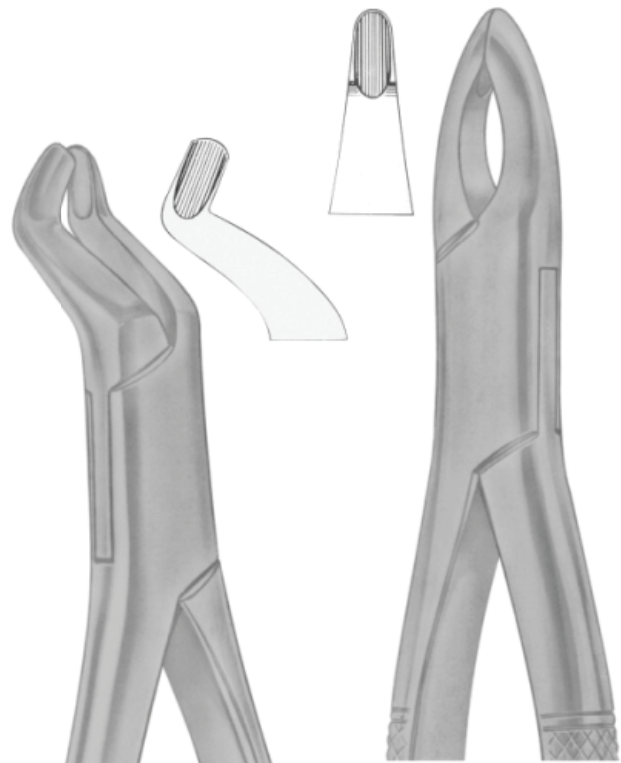

**1278**  
Fig. 213  
upper centrals and canines



**1276**  
Fig. 201  
upper incisors,  
canines, premolars



**1277**  
Fig. 210H  
upper third molars



**1279**  
Fig. 217  
lower molars

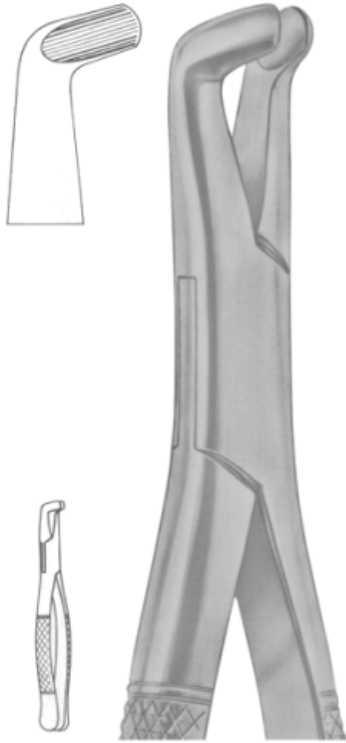

**1280**  
Fig. 222  
lower third molars



**1282**  
Fig. 286  
Swing lower molars



**1283**  
Fig. 288  
lower canines  
and premolars

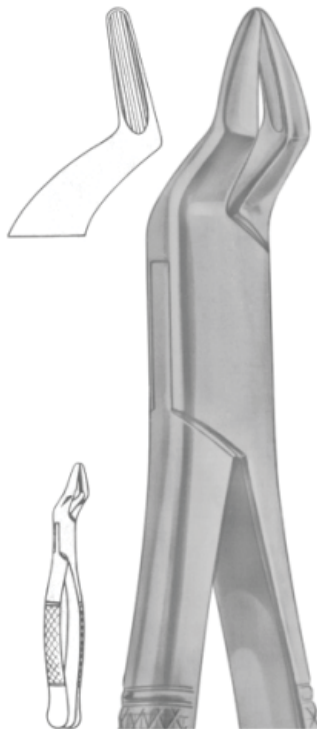

**1281**  
Fig. 286  
upper incisors and roots



**1284**  
COHEN  
Fig. 310  
universal forceps

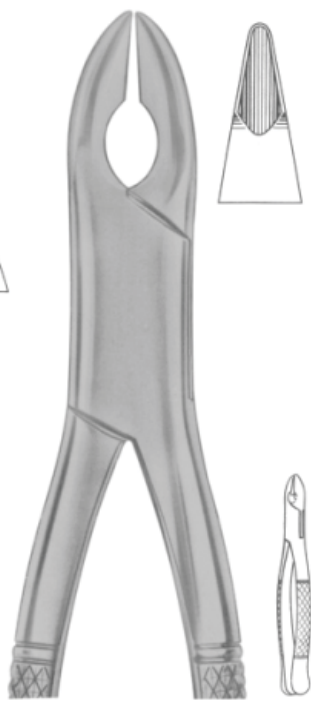

**1285**  
NEVIUS  
Fig. 320/10S  
upper canines



**1287**  
NEVIUS  
Fig. 325/10H  
upper canines

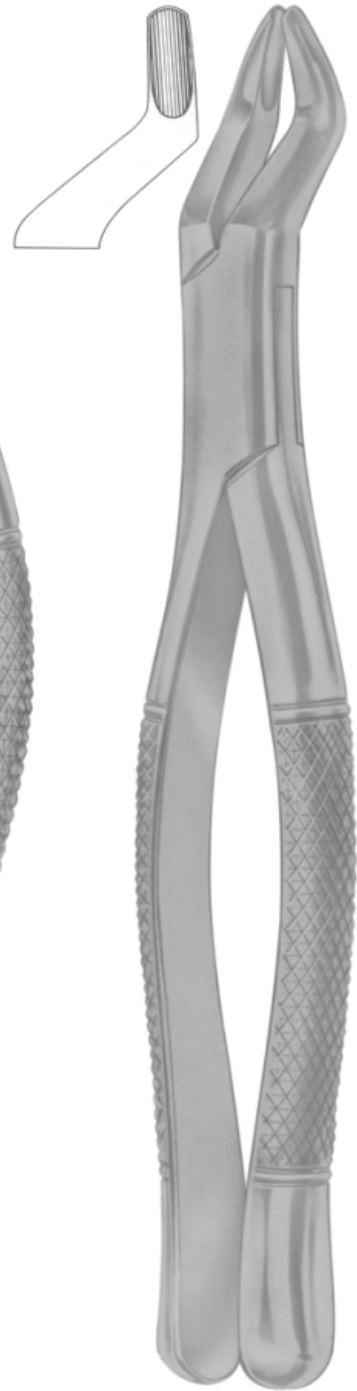

**1288**  
STANDARD  
Fig. 330/4  
upper third molars



**1286**  
HENAHAN  
Fig. 315/1A upper incisors



**1289**  
WOODWARD  
Fig. 335/FH  
lower molars



**1291**  
WOODWARD  
Fig. 335/FS  
lower molars



**1290**  
Fig. 340/89  
upper molars right

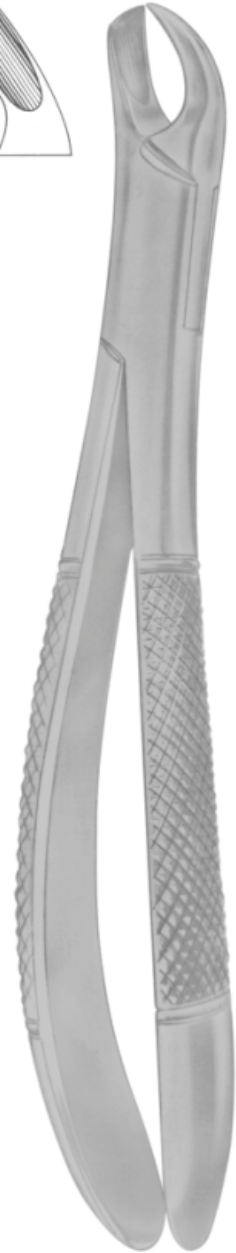

**1292**  
Fig. 345/90  
upper molars left



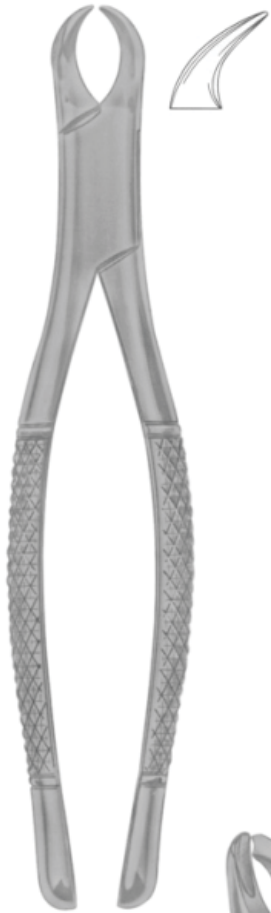

**1293**  
Fig. 350/23S  
lower molars



**1294**  
Fig. 355/23SK  
lower molars



**1295**  
Forcep Fig. 301



**1295-A**  
Forcep Fig. 300



**1296**  
Fig. 360/17SK  
lower molars



**1297**  
Fig. 365/150SK  
upper anteriors  
and roots



**1298**  
Fig. 370/151SK  
lower anteriors  
and roots



1299  
Molt 9



1300  
Allen 9A



1301  
Prichard



1302  
Seldin

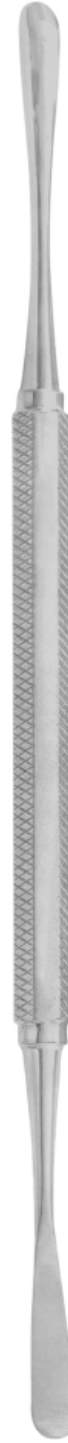

1303  
Goldman- Fox 14



1304  
West  
Dell W2

Heidbrink Root - Tip Picks

Root Tip



1305  
DEL 78



1306  
DEL 79



1307  
DEL 80



1308  
DEL H1



1309  
DEL H2



1310  
DEL H3



1311  
DEL H2-3



1312  
POTT  
6X



1313  
POTT  
7X



**1314**  
BUSER



**1315**  
OHI 10



**1316**  
HOWARD 9H



**1317**  
FREER



**1318**  
FREER 15



**1319**  
FREER 16

lower jaw, left side

lower jaw, right side



**1320**  
BEIN  
Fig. 4



**1331**



**1332**

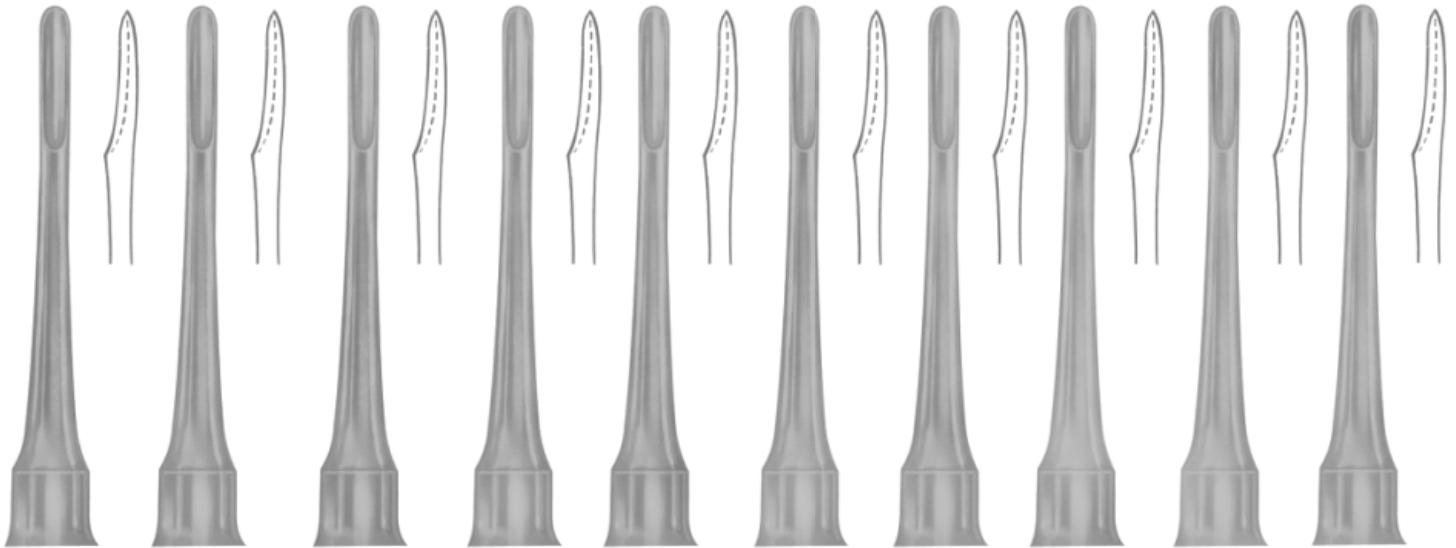

**1321**  
BEIN  
1.0 mm

**1322**  
BEIN  
1.5 mm

**1323**  
BEIN  
2.0 mm

**1324**  
BEIN  
2.5 mm

**1325**  
BEIN  
3.0 mm

**1326**  
BEIN  
3.5 mm

**1327**  
BEIN  
4.0 mm

**1328**  
BEIN  
4.5 mm

**1329**  
BEIN  
5.0 mm

**1330**  
BEIN  
5.5 mm



1334  
BEIN  
Fig. 1



1335  
BEIN  
Fig. 2



1336  
BEIN  
Fig. 0



1337  
BEIN  
Fig. 3



1333  
BEIN

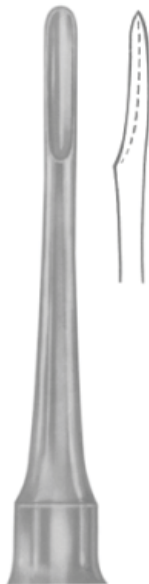

1338  
BEIN  
Fig. 4



1339  
BEIN  
Fig. 5



1340  
BEIN  
Fig. 6



**1341**  
CRYER  
Fig. 3



**1342**  
CRYER  
Fig. 4



**1343**  
CRYER  
Fig. 12



**1344**  
CRYER  
Fig. 27



**1345**  
CRYER  
Fig. 28



**1346**  
CRYER  
Fig. 27S



**1347**  
CRYER  
Fig. 28S



**1348**  
SELDIN  
Fig. 2



**1349**  
SELDIN  
Fig. 3



**1350**  
SELDIN  
Fig. 4L



**1351**  
SELDIN  
Fig. 4R



**1352**  
SELDIN  
Fig. 1L



**1353**  
SELDIN  
Fig. 1R



1354



1355



1356



1357

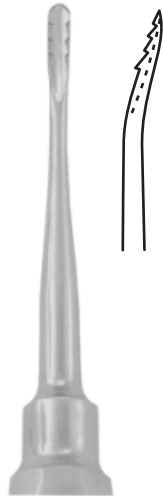

1358

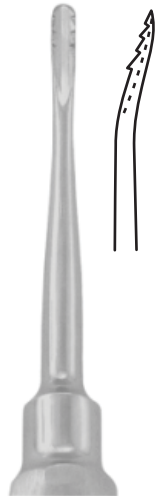

1359

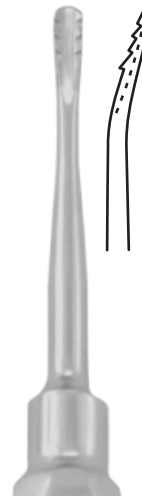

1360

## Root Screws



1362  
Morrison  
2.0 mm



1363  
Morrison  
2.5 mm



1364  
Morrison  
3.0 mm

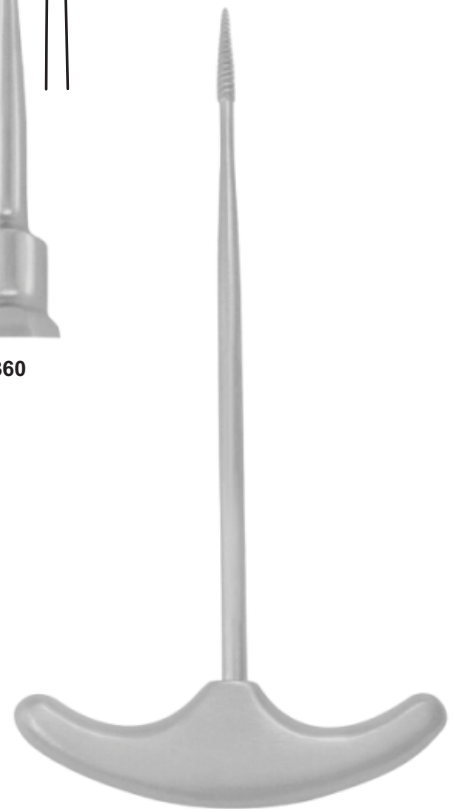

1361  
Morrison  
3.5 mm





**1365**  
IS-APICAL



**1366**  
APICAL  
2 mm  
Fig. 1



**1367**  
APICAL  
3 mm  
Fig. 2



**1368**  
APICAL  
4 mm  
Fig. 3



**1369**  
APICAL  
4.5 mm  
Fig. 4



**1370**  
APICAL  
2 mm  
Fig. 5



**1371**  
APICAL  
3 mm  
Fig. 6



**1372**  
APICAL  
4 mm  
Fig. 7



**1373**  
APICAL  
4.5 mm  
Fig. 8



**1374**  
APICAL  
Fig. 9



**1375**  
WINTER  
Fig. 14 L



**1376**  
WINTER  
Fig. 14 R



**1377**  
HEIDBRINK  
Fig. 1



**1378**  
HEIDBRINK  
Fig. 2



**1379**  
FLOHR  
Fig. 1



**1380**  
FLOHR  
Fig. 2



**1381**  
APICAL  
Fig. 1



**1382**  
APICAL  
Fig. 2



**1383**  
IS-CRYER



**1384**  
CRYER  
Fig. 1



**1385**  
CRYER  
Fig. 2



**1386**  
IS-COUPLAND



**1387**  
COUPLAND  
Fig. 1



**1388**  
COUPLAND  
Fig. 2



**1389**  
COUPLAND  
Fig. 3



1390  
Fig. 1



1391  
Fig. 2



1392  
Fig. 3



1393  
FLOHR  
Fig. 1



1394  
FLOHR  
Fig. 2

1395  
FLOHR  
Fig. 3



**1396**  
KOPP  
Fig. 1



**1397**  
KOPP  
Fig. 2



**1403**  
KOPP  
Fig. 1



**1404**  
KOPP  
Fig. 2



**1396**  
KOPP



**1398**  
KOPP  
Fig. 3



**1399**  
KOPP  
Fig. 4



**1402**  
KOPP



**1405**  
KOPP  
Fig. 3



**1406**  
KOPP  
Fig. 4



**1400**  
KOPP  
Fig. 5



**1401**  
KOPP  
Fig. 6



1407  
HYLIN

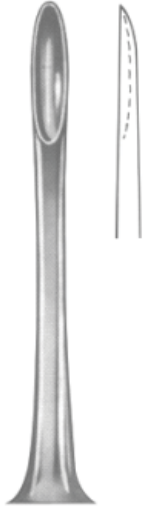

1407  
HYLIN  
Fig. 1



1408  
HYLIN  
Fig. 2



1409  
BEIN

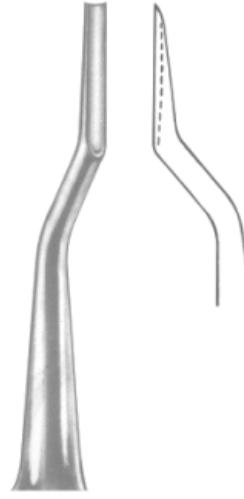

1409  
BEIN  
Fig. 1

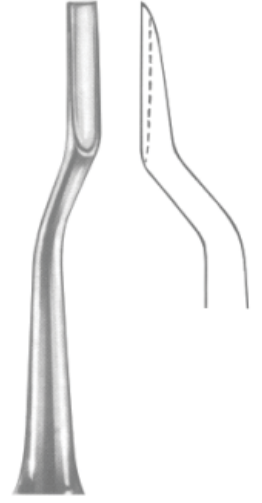

1410  
BEIN  
Fig. 2



1411  
BEIN  
Fig. 3

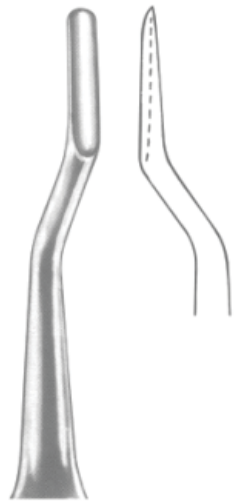

1412  
BEIN  
Fig. 4



**1413**  
WARWICK-JAMES  
Fig. 1



**1413**  
Warwick-James  
Fig. 2



**1414**  
Warwick-James  
Fig. 3



**1415**  
London-Hospital  
Fig. 1



**1415**  
London-Hospital  
Fig. 2



**1416**  
London-Hospital  
Fig. 3



**1417**  
OTT



**1418**  
CHOMPRET  
Fig. 1



**1419**  
CHOMPRET  
Fig. 2



**1420**  
CHOMPRET  
Fig. 3



**1421**  
CHOMPRET  
Fig. 4



**1423**  
Fig. 1



**1422**  
Fig. 2

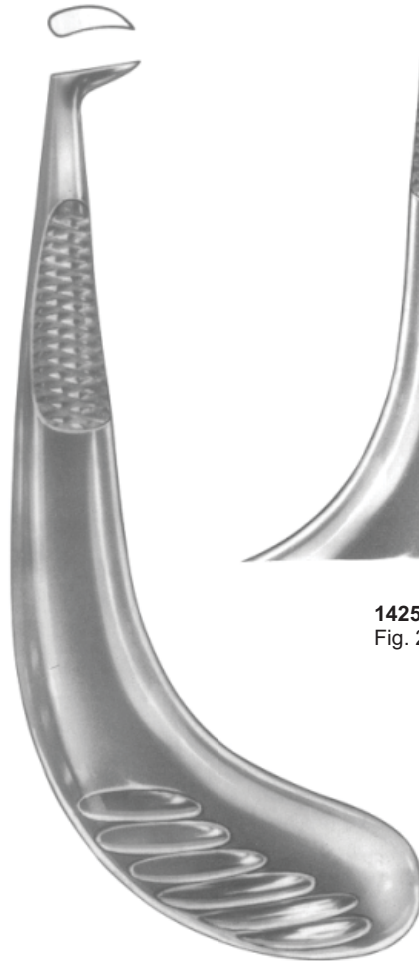

**1424**  
Fig. 1



**1425**  
Fig. 2



**1426**  
APICAL



1427  
IS-Fig. 1



1428  
Fig. 2



1429  
Fig. 3



1430  
HEIDBRINK  
Fig. 1



1431  
HEIDBRINK  
Fig. 2



1432  
HEIDBRINK  
Fig. 3



1438  
MEAD  
MD1



1433  
LECLUSE



1434  
MEAD  
MD-5 A



1435  
MEAD  
MD-6 A



1436  
MEAD  
MD-7 A



1437  
MEAD  
MD-8





**1439**  
WINTER  
Fig. 1L



**1440**  
WINTER  
Fig. 1R



**1441**  
WINTER  
Fig. 2L



**1442**  
WINTER  
Fig. 2R

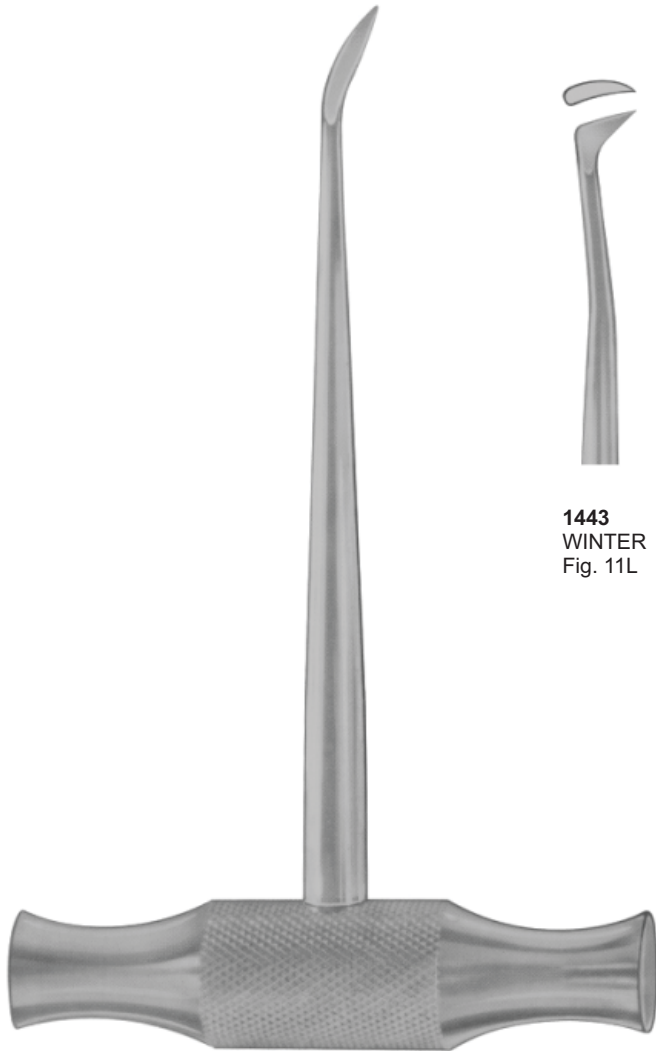

**1439**  
WINTER



**1443**  
WINTER  
Fig. 11L



**1444**  
WINTER  
Fig. 11R



**1445**  
WINTER  
Fig. 12L



**1446**  
WINTER  
Fig. 12R



**1447**  
WINTER  
Fig. 14L



**1448**  
WINTER  
Fig. 14R



1449  
BARRY  
Fig. 1



1450  
BARRY  
Fig. 2



1451  
BARRY  
Fig. 3



1452  
BARRY  
Fig. 4



1449  
BARRY



1453  
BARRY  
Fig. 11



1454  
BARRY  
Fig. 12



1455  
BARRY  
Fig. 17



1456  
BARRY  
Fig. 18



1458  
CRYER  
Fig. 26



1459  
SELDIN  
Fig. 27



1460  
CRYER  
Fig. 28



1461  
CRYER  
Fig. 29



1462  
HEIDBRINK  
Fig. 22



1463  
HEIDBRINK  
Fig. 23

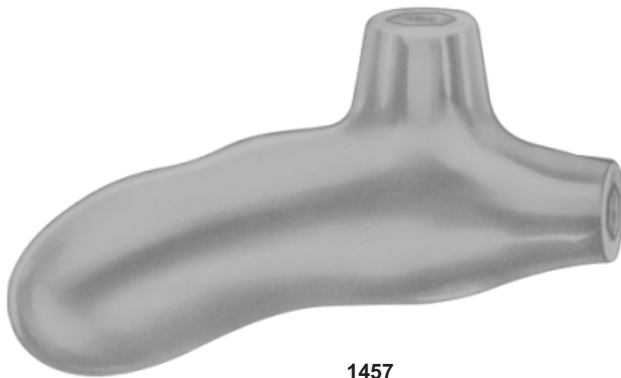

1457



**1465**  
KOPP  
Fig. 31



**1466**  
KOPP  
Fig. 32



**1467**  
KOPP  
Fig. 33



**1468**  
KOPP  
Fig. 34



**1469**  
KOPP  
Fig. 35



**1470**  
KOPP  
Fig. 44

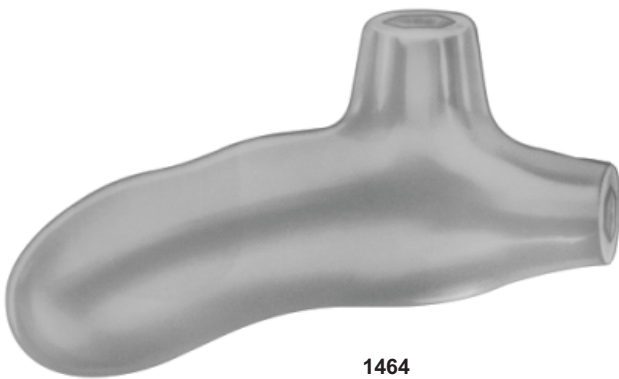

**1464**



1472  
HEIDBRINK  
Fig. 10



1473  
WINTER  
Fig. 11



1474  
WINTER  
Fig. 12



1475  
BARRY  
Fig. 17



1476  
BARRY  
Fig. 18



1477  
BARRY  
Fig. 20



1471

Root Elevators according to Dr. Sader,  
with interchangeable working tips

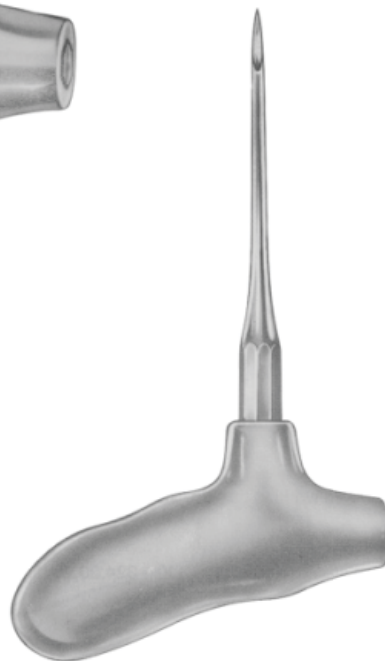

1478



1479



1480

1481  
Root Elevator, Plastic Handle, Set of 10 Pcs

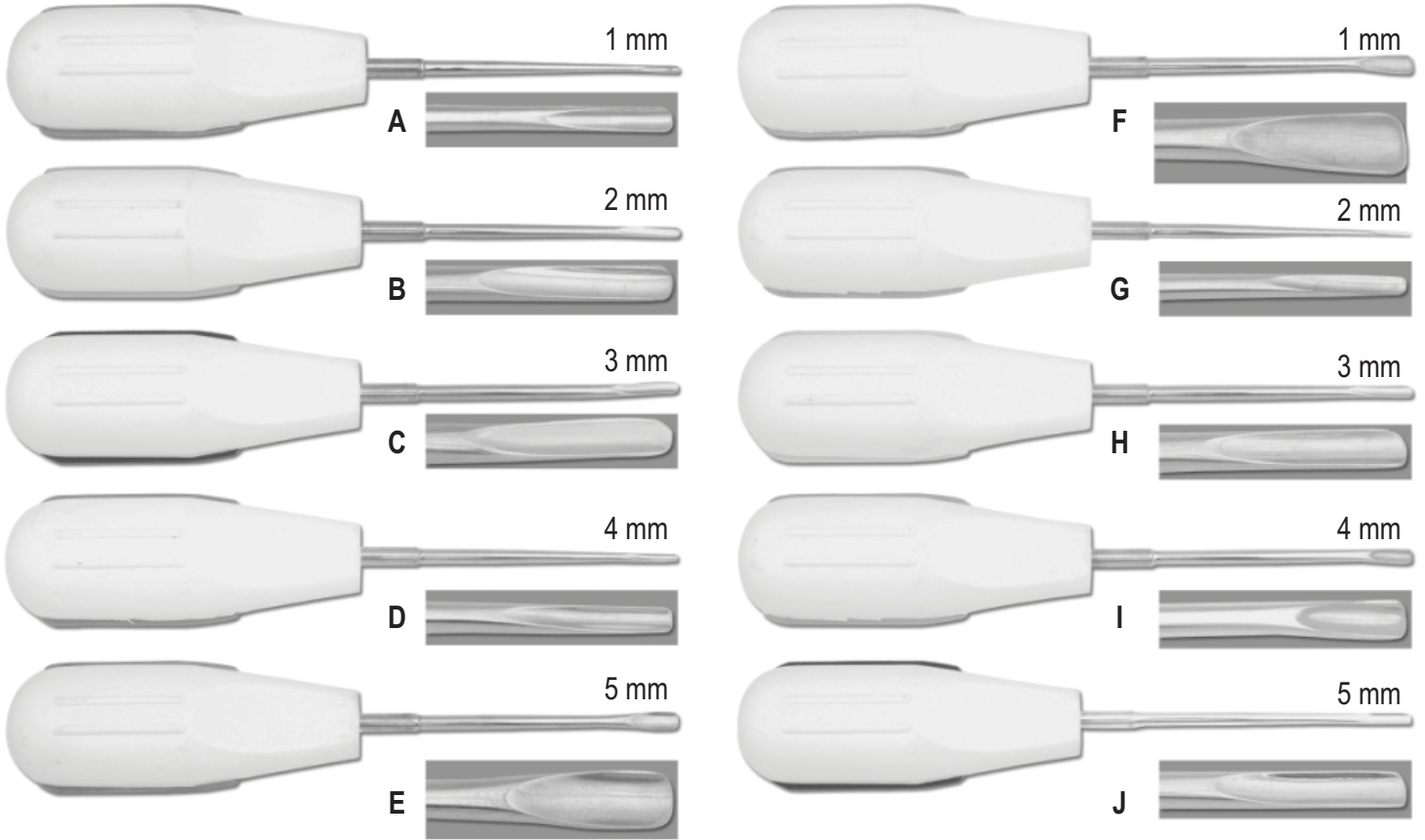

1482  
Root Elevator, Plastic Handle, Set of 5 Pcs

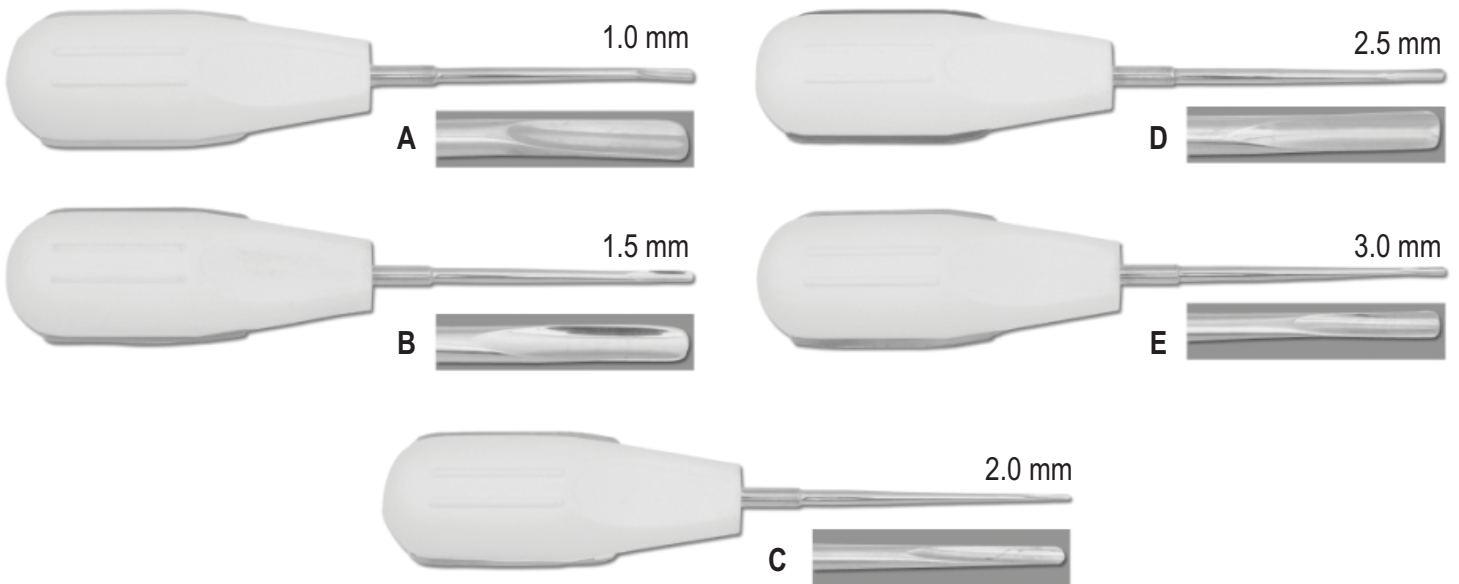

- ◁ ▷ Scalpel Handles
- ◁ ▷ Mouth Mirrors and Handles
- ◁ ▷ Explorer and Probes
- ◁ ▷ Endodontics
- ◁ ▷ Excavators



# 02

SECTION





**1483**  
Scalpel Handle Angle Of Blade Adjusts To Easily Get Around Corners  
Adjustment Sets Blade From Straight To Back Angled  
Locks In At 90°, 60°, 30°, Straight, -30°, -60° Angles



**1484**  
Scalpel Handle  
Fig. 5



**1485**  
Scalpel Handle  
Curved



**1486**  
Fig. 3L



**1487**  
Fig. 7



**1488**  
Scalpel Handle  
Fig. 4L, Curved  
20 cm



**1489**  
Fig. 3



**1490**  
Fig. 3G



**1491**  
Fig. 4



**1492**



**1493**  
Scalpel Handle  
4 D 14.0 cm



**1494**  
Mess Holders



**1495**  
Gouge  
Blade Handle  
Fig. 2 / 11.5 cm





Handle For Mouth Mirrors, Probes, Explorers, Excavators, Carvers, Curettes & Scalars



**1496**  
Handle No. 2 Standard Single Ended



**1497**  
Handle Single Ended



**1498**  
Handle Single Ended



**1499**  
Handle Single Ended



**1500**  
Octagonal Double Ended



**1501**  
Octagonal Double Ended



**1502**  
Octagonal Double Ended



**1503**  
Handle No. 2 (Standard Double Ended)



**1504**  
Octagonal Double Ended



**1505**  
Tactile Tone Double Ended



**1506**  
Tactile Tone Double Ended



**1507**  
Tactile Tone Double Ended



**1508**  
Handle, Double Ended



**1509**  
Double Ended



**1510**  
Tactile Tone Double Ended



**1511**  
Tactile Tone Double Ended



## Mouth Mirrors



### Mouth Mirrors, Magnifying 1513-A Plain 1512-B

Fig. 00	Ø	8 mm
Fig. 0	Ø	10 mm
Fig. 1	Ø	14 mm
Fig. 2	Ø	16 mm
Fig. 3	Ø	18 mm
Fig. 4	Ø	20 mm
Fig. 5	Ø	22 mm
Fig. 6	Ø	24 mm
Fig. 7	Ø	26 mm
Fig. 8	Ø	28 mm
Fig. 9	Ø	30 mm
Fig. 10	Ø	32 mm

### Plane



**1514**  
Fig.6  
Ø 26 mm

**1515**  
Fig.5  
Ø 24 mm

**1516**  
Fig.4  
Ø 22 mm

### Magnifying



**1517**  
Fig.6  
Ø 26 mm

**1518**  
Fig.5  
Ø 24 mm

**1519**  
Fig.4  
Ø 22 mm

### Front surface



**1520**  
Fig.6  
Rhodium  
Ø 26 mm  
Front surface

**1521**  
Fig.5  
Rhodium  
Ø 24 mm  
Front surface

**1522**  
Fig.4  
Rhodium  
Ø 22 mm  
Front surface

### Plane



**1523**  
Fig.6  
Ø 26 mm

**1524**  
Fig.5  
Ø 24 mm

**1525**  
Fig.4  
Ø 22 mm

### Magnifying



**1526**  
Fig.6  
Ø 26 mm

**1527**  
Fig.5  
Ø 24 mm

**1528**  
Fig.4  
Ø 22 mm

**1512**  
Hollow Handle  
Fig.1

**1513**  
Hollow Handle  
Fig.2

With cone - socket



1529



1530



1531



1532



1533



1534



1535  
Parallelometer  
mouth mirror

1536  
Parallelometer  
mouth mirror  
+ handle  
code 2101

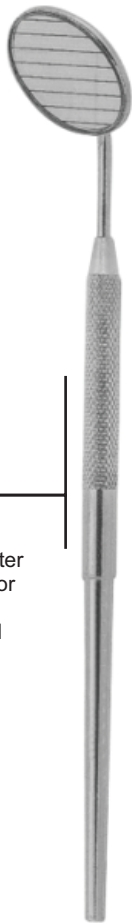

1537  
Tactile Tone  
Single Ended



1538  
Handle  
Thompson  
Single Ended



1539  
Hollow Handle



1540  
Hollow Handle  
Stainless  
Steel



1541  
Cone-socket  
Hollow Handle



1542  
Hollow Handle



1543  
Hollow Handle

SCALERS - JAQUETTE

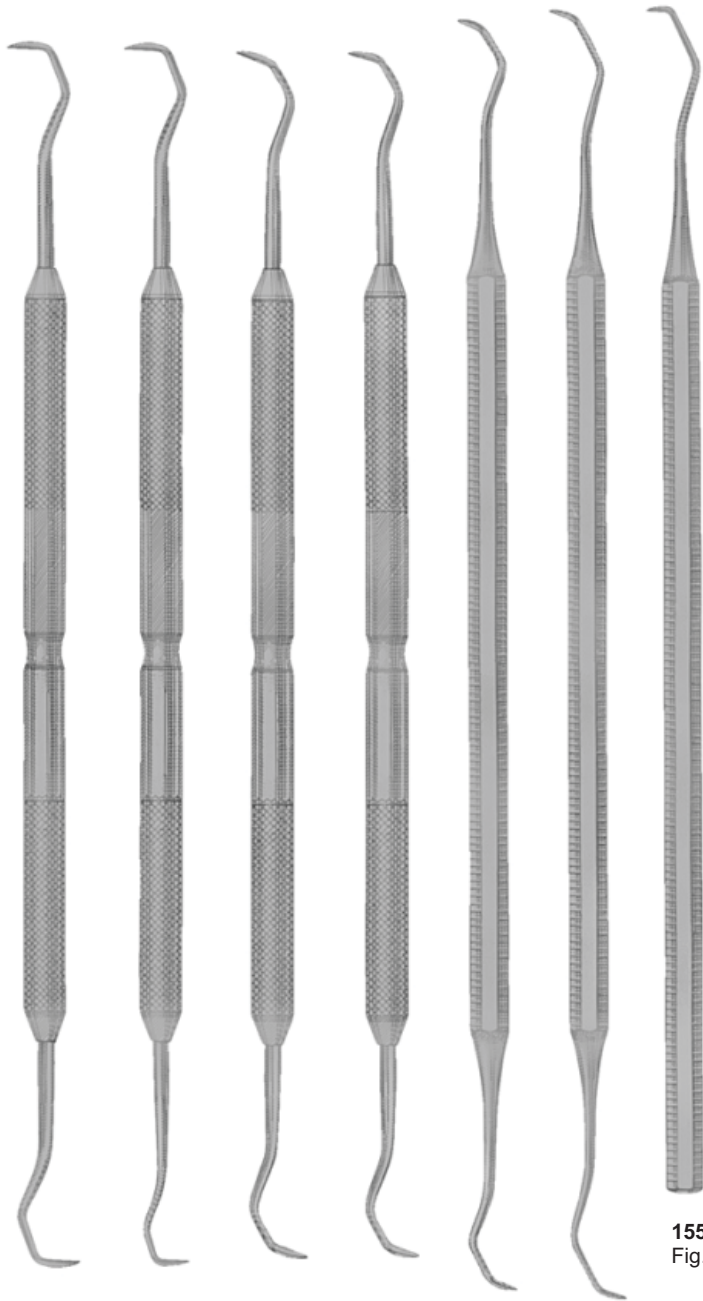

1544 1Y-1Y  
1545 1Y-1YS  
1546 2Y-3Y  
1547 2YS-3YS  
1548 2-3  
1549 2S-3S

1550  
Fig.1

SCALERS - OCTAGONAL

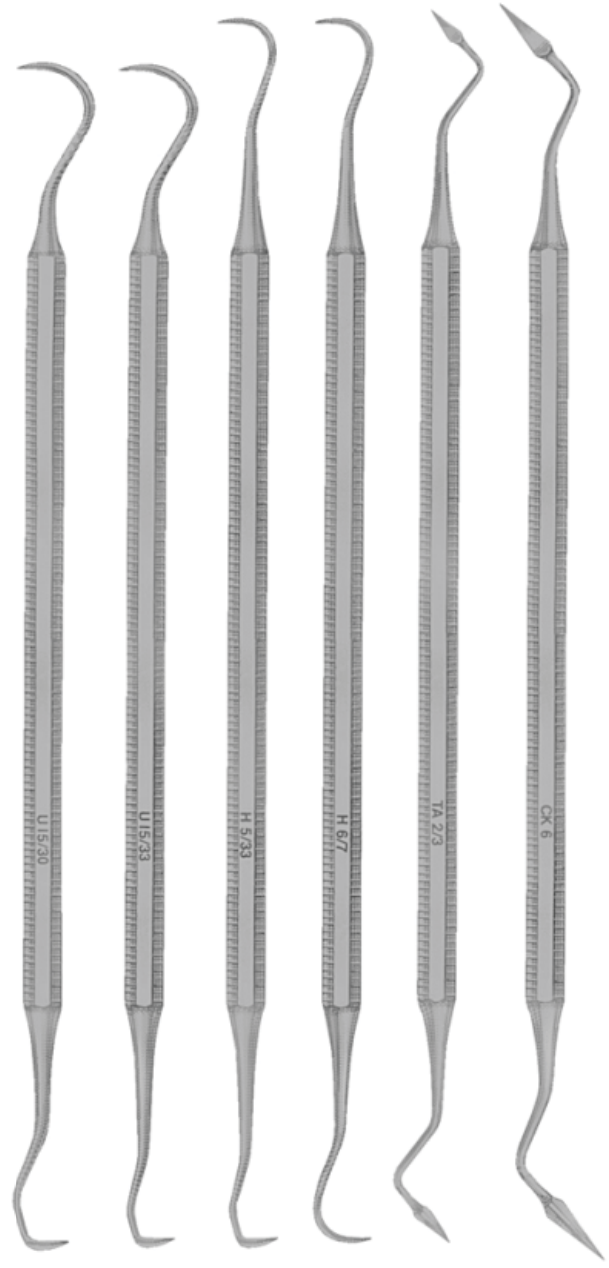

1551 U15-30  
1552 U15-33  
1553 H5-33  
1554 H6-7  
1555 Taylor 2-3  
1556 CK6



1557  
U15



1558  
No. 3



1559  
No. 12



1560  
WHITESIDE 1-0

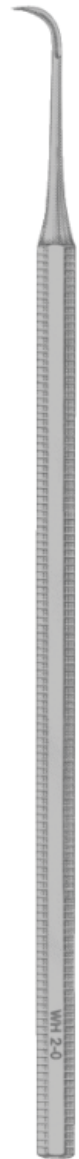

1561  
WHITESIDE 2-0

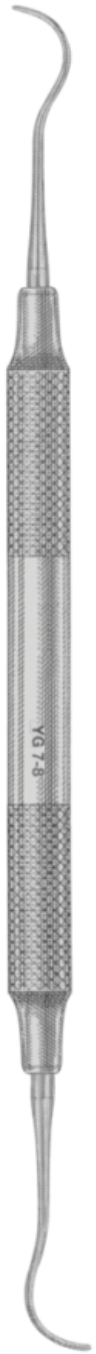

**1562**  
YAOUNGER/GOOD  
7-8

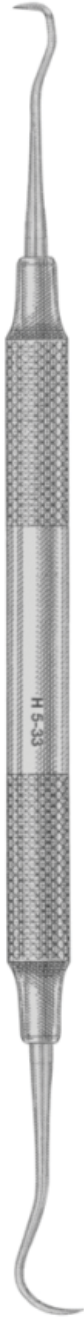

**1563**  
H5-33

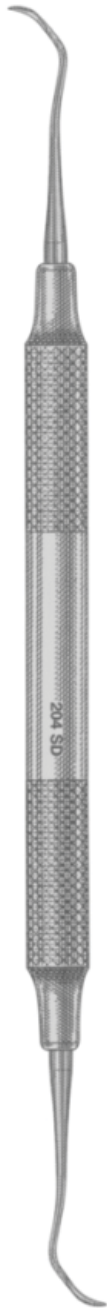

**1564**  
204SD



**1565**  
H6-7



**1566**  
204S



**1567**  
TOWNER/JAQUETTE  
U15-30

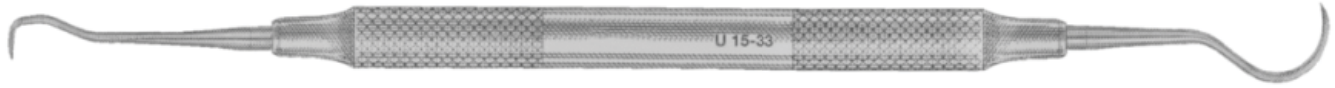

1568  
JAQUETTE (33-U15)



1569  
JAQUETTE  
2Y-3Y



1570  
JAQUETTE  
30-U15



1571  
JAQUETTE  
2YS-3YS



1572  
JAQUETTE  
33-H5



1573  
YOUNGER/GOOD  
7-8



1574  
204S

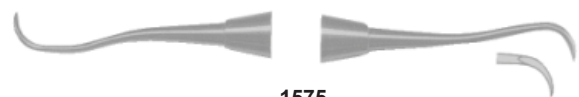

1575  
204SD



1576  
H6-7

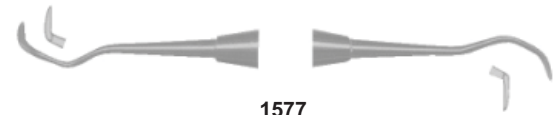

1577  
JAQUETTE  
2S-3S



1578  
JAQUETTE  
1Y-1YS

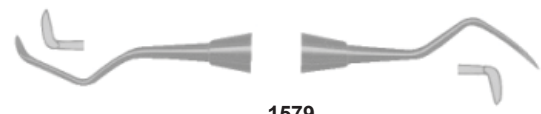

1579  
JAQUETTE  
2-3



1580  
JAQUETTE (33-U15)



1581  
S204



1583  
S204S



1585  
S204SD



1587  
Goldman 6-7



1589  
Goldman Fox 21



1591  
H5-U15



1593  
Jaquette 34-35



1595  
Thompson Jr.



1597  
UT107-108



1599  
UP128

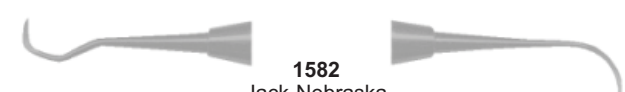

1582  
Jack-Nebraska



1584  
Jaquette 1-U15



1586  
Jaquette 2-3

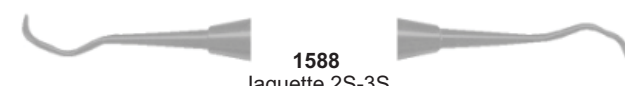

1588  
Jaquette 2S-3S

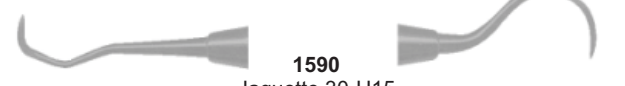

1590  
Jaquette 30-U15



1592  
Jaquette 30-33



1594  
Jaquette 31-32



1596  
Jaquette 33-H5



1598  
U 6-7



1600  
128L



Explorers Double Ended - Octagonal

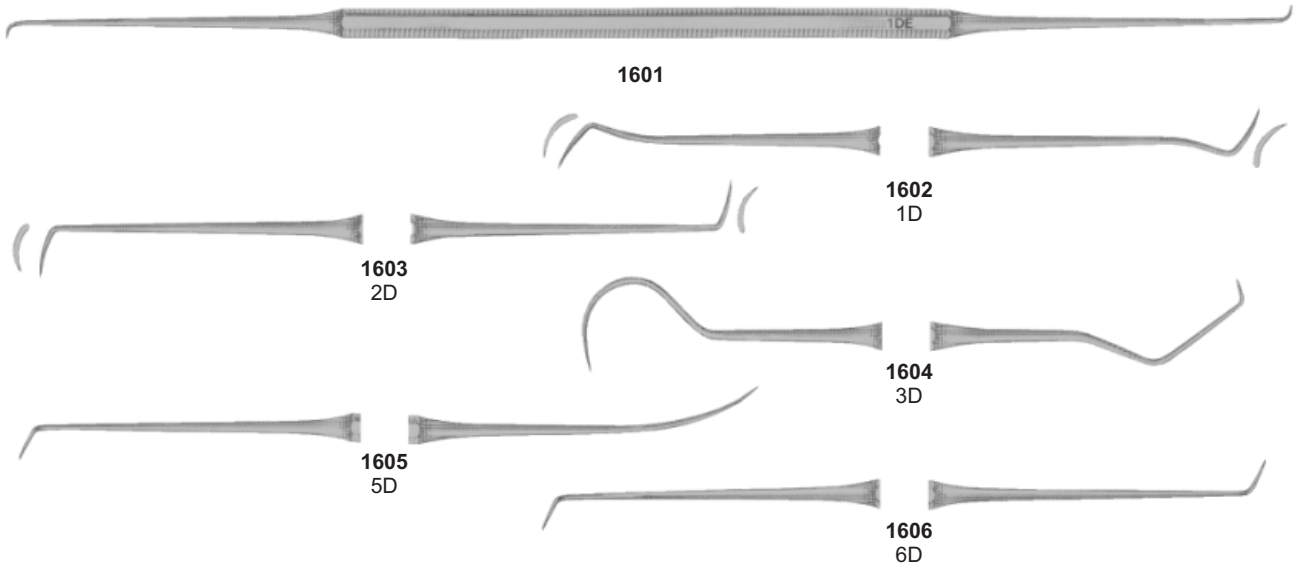

Explorers Double Ended - Standard

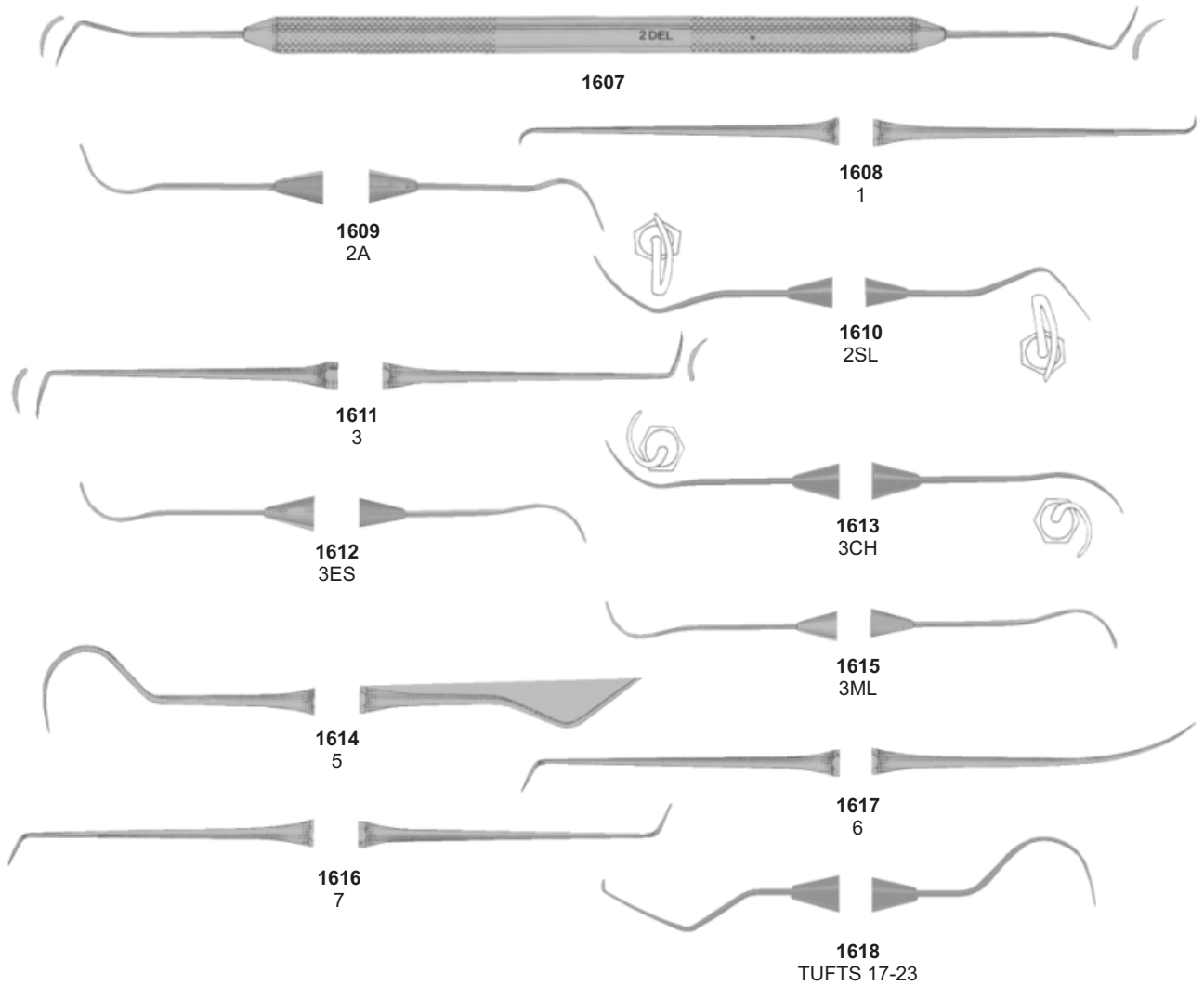

Explorers Double Ended Tactile Tone



1619  
2A



1620  
2



1621  
1



1622  
2SL



1623  
3



1624  
3CH



1625  
3ES



1626  
3ML

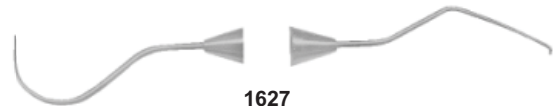

1627  
5



1628  
6



1629  
7

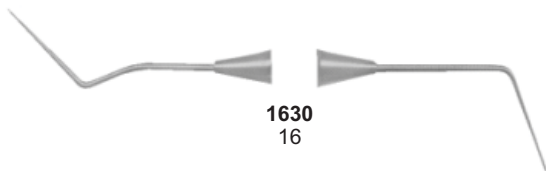

1630  
16



1631  
TUFTS 17/23

Explorers Single Ended - Octagonal



**1632**  
Fig. 3A



**1633**  
Fig. 6



**1634**  
Fig. 7



**1635**  
Fig. 17



**1636**  
Fig. 23

Explorers Single Ended - Standard



**1637**  
Fig. 3A



**1638**  
Fig. 6



**1639**  
Fig. 7

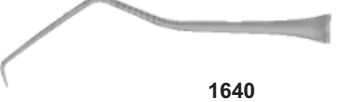

**1640**  
Fig. 17



**1641**  
Fig. 23

Probe / Explorer - Octagonal

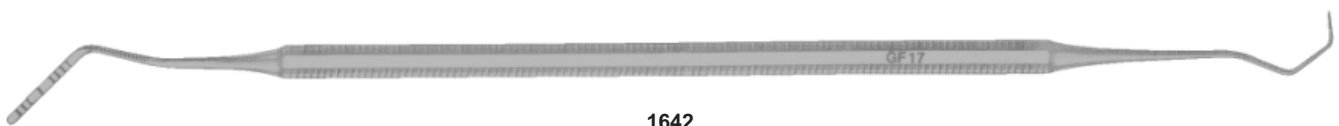

**1642**  
GF-17

Double Ended Probe - Octagonal



**1643**  
GF-18 (1-2)

Probes Double Ended - Standard

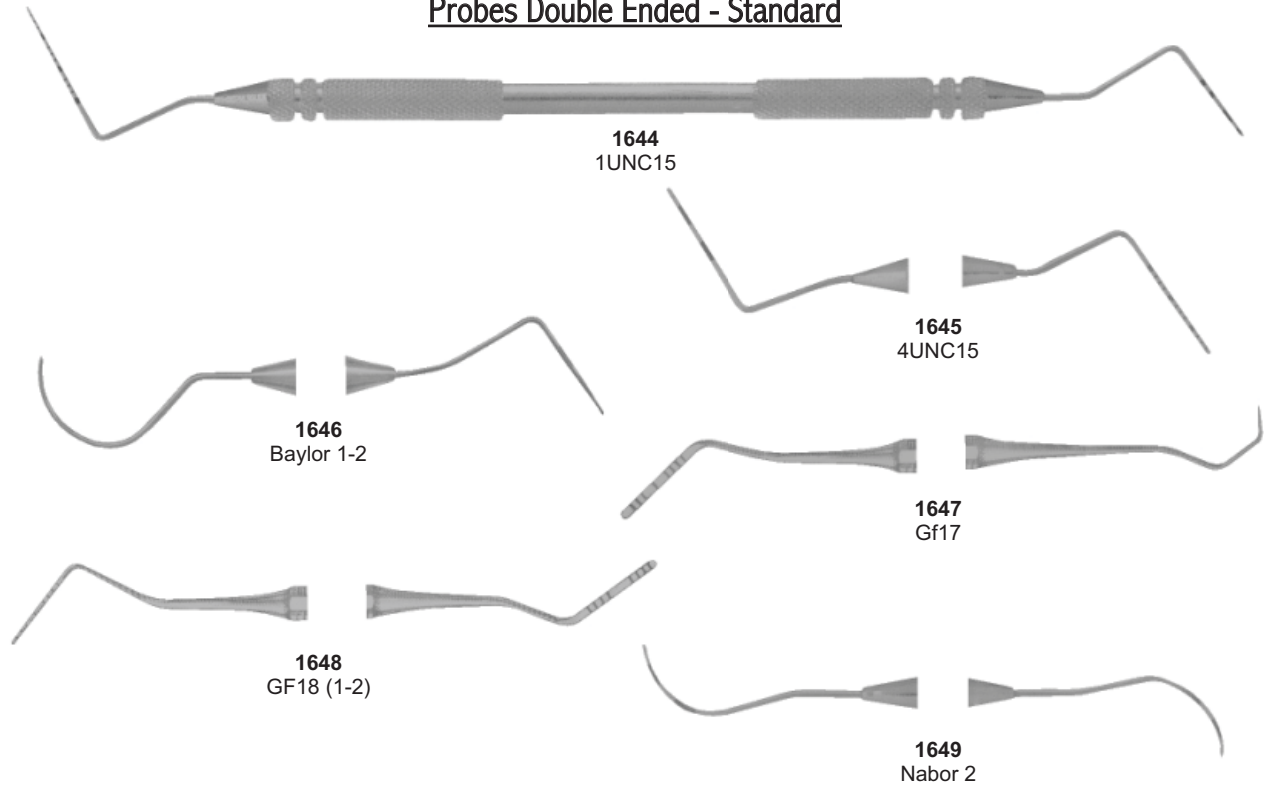

Probes Double Ended - Tactile Tone

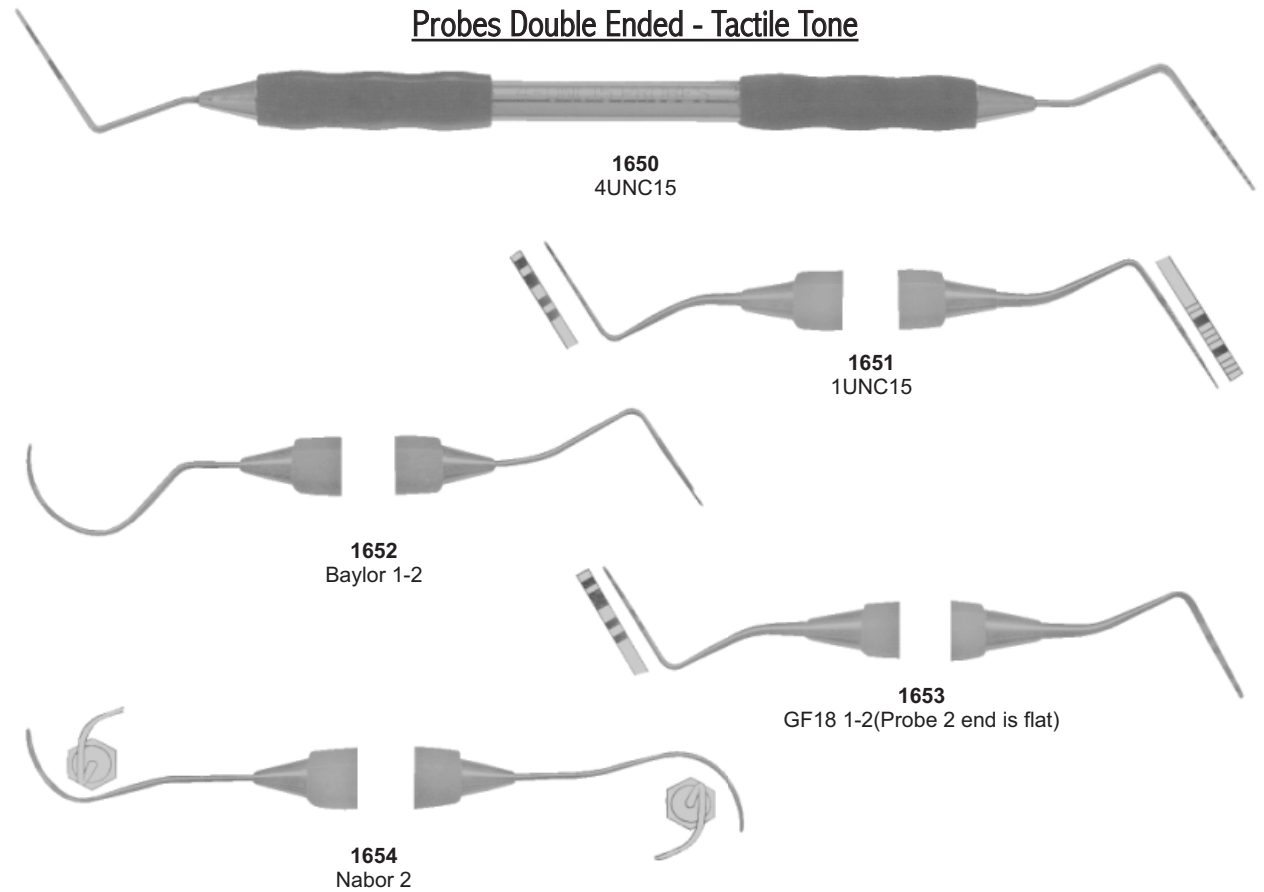

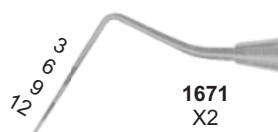
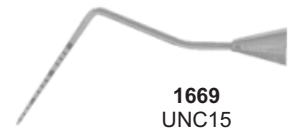
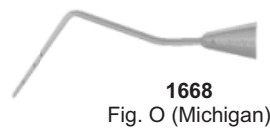
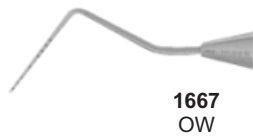
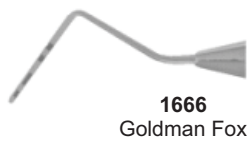
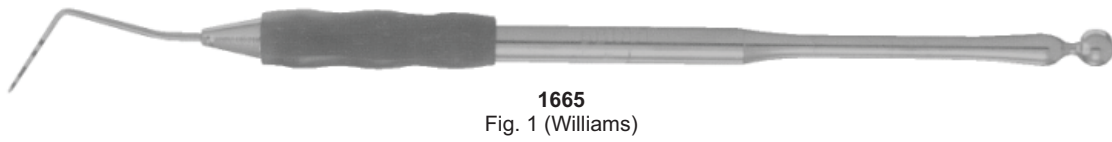
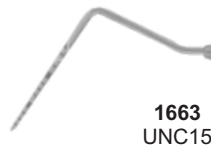
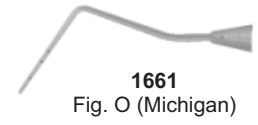
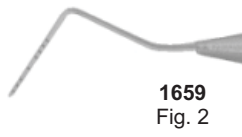
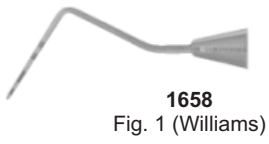
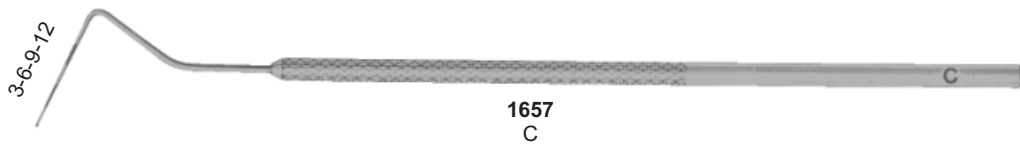
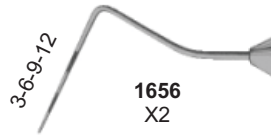
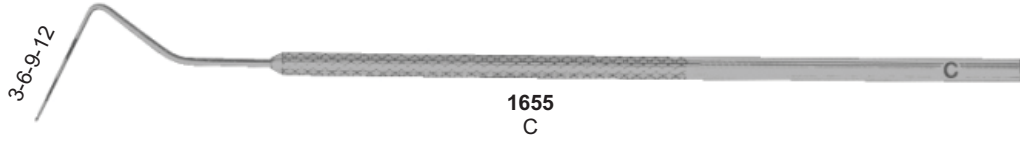

**PROBES DOUBLE ENDED STANDARD**

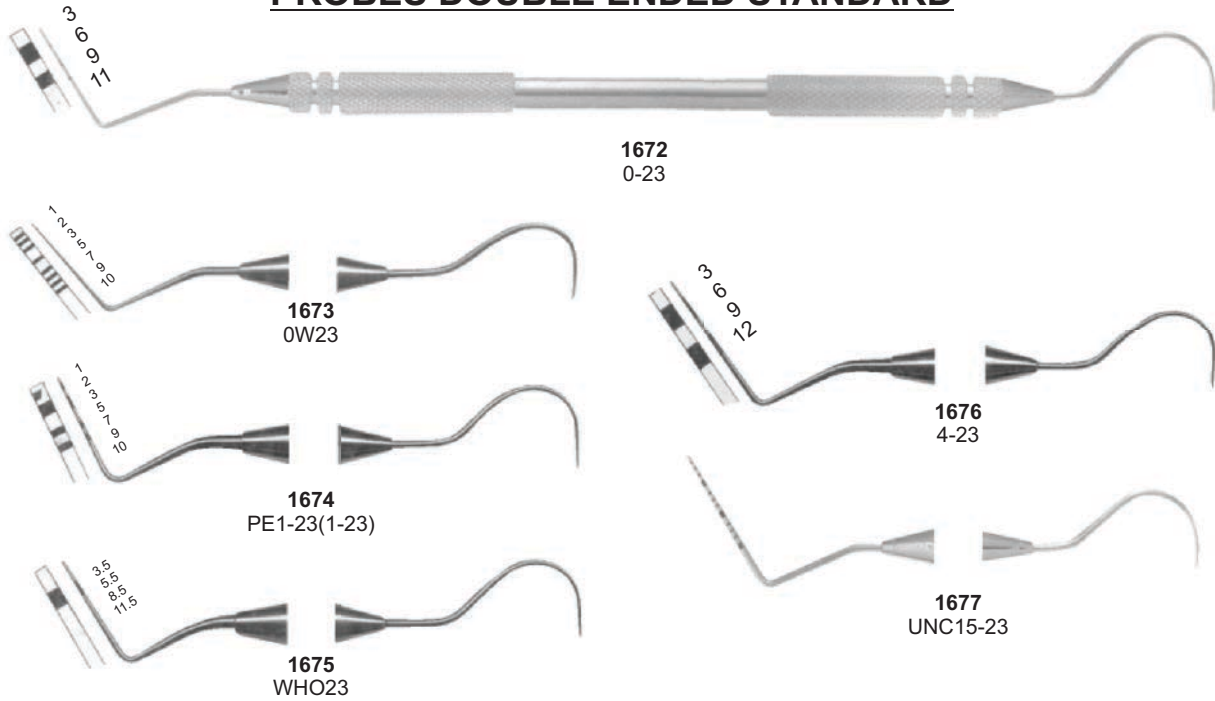

**PROBES DOUBLE ENDED TACTILE TONE**

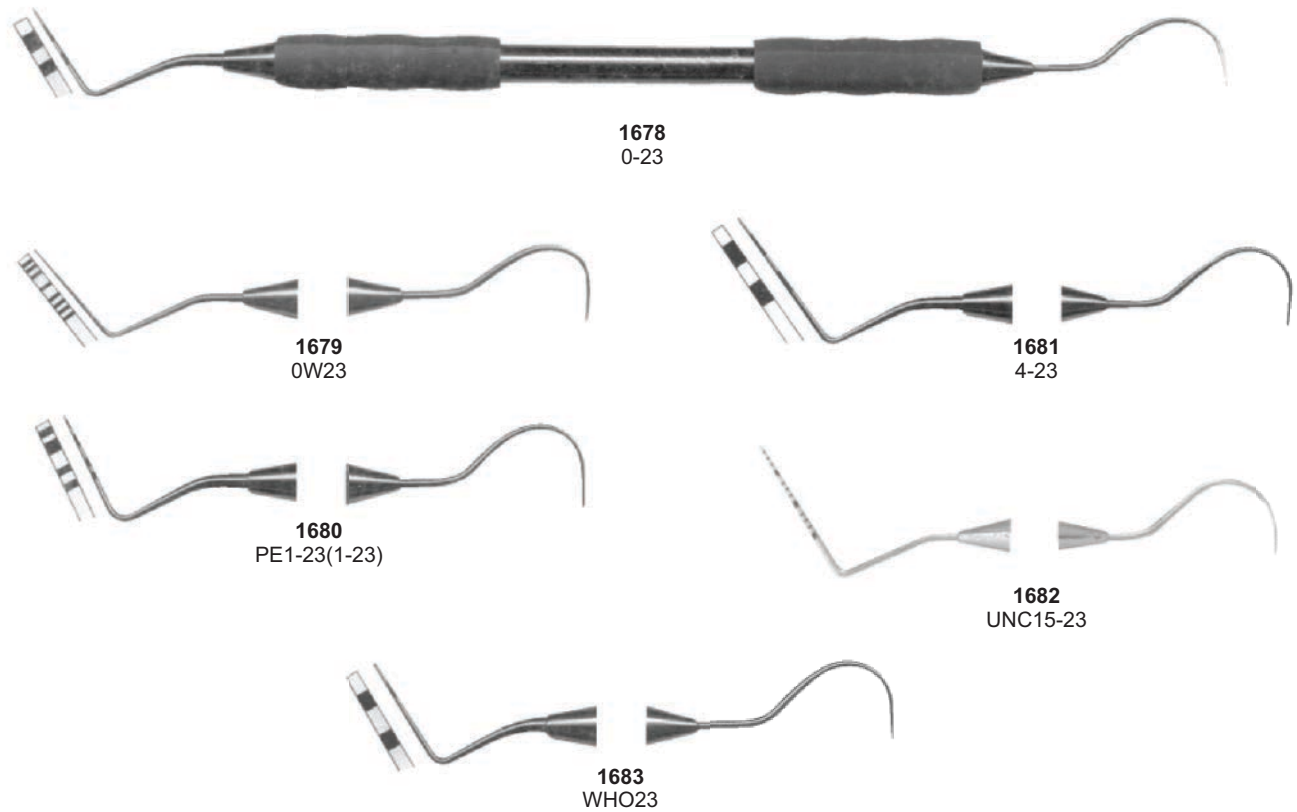

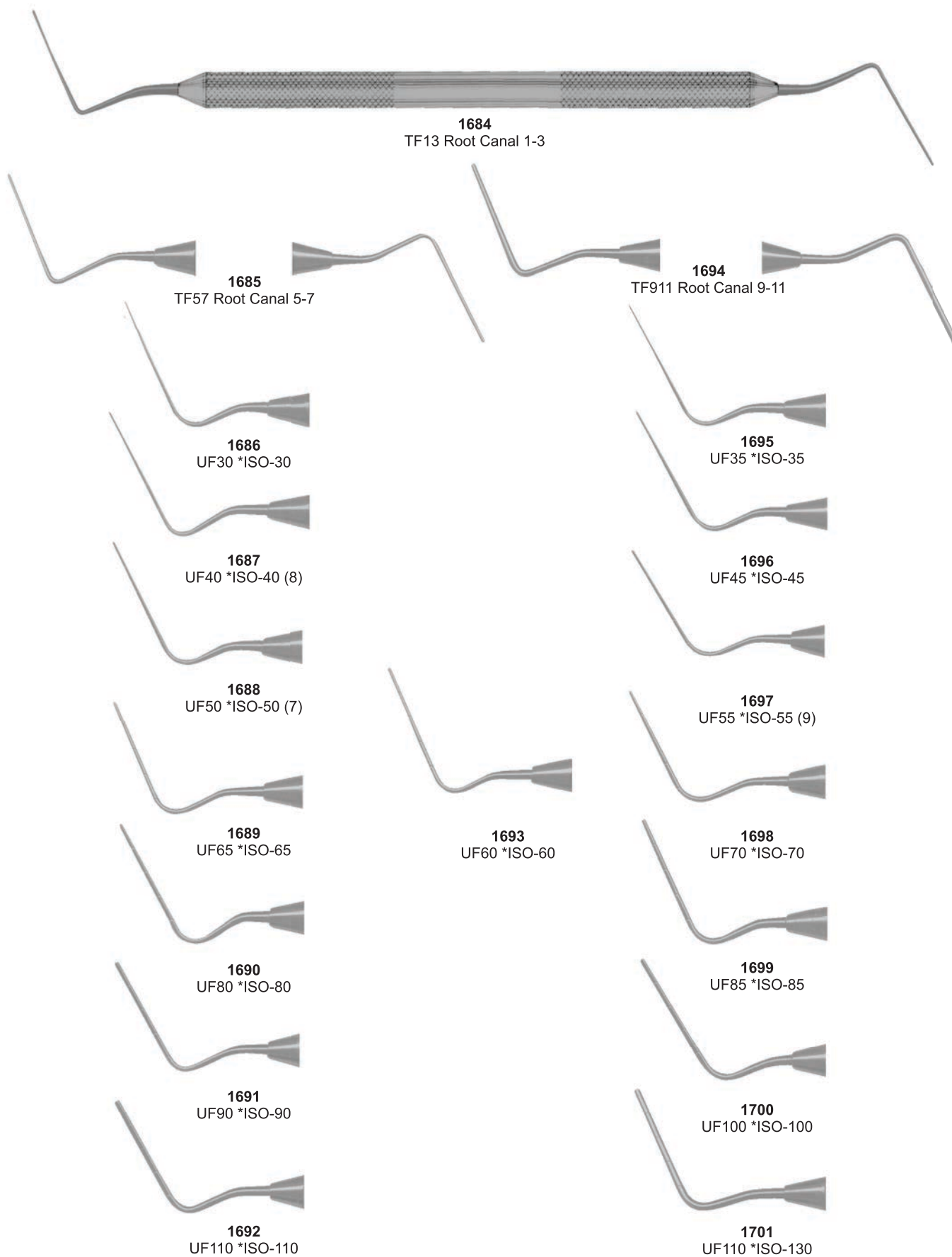



**1702**  
UF120X



**1703**  
UF45N



**1704**  
UF60N



**1705**  
UF80N



**1706**  
UF100X



**1707**  
UE25 R-25



**1708**  
UE30 R-30



**1709**  
UE35 R-35



**1710**  
UE40 R-40



**1711**  
UE45 R-45



**1712**  
UE50 R-50



**1713**  
UF120X

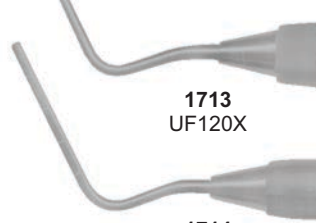

**1714**  
UF140X



**1715**  
TFD3545N



**1716**  
TFD6080N



**1717**  
UE55 R-55



**1718**  
UE60 R-60



**1719**  
UE25N R-25



**1720**  
UE30N R-30

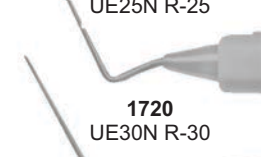

**1721**  
UE40N R-40





**1722**  
No. D11

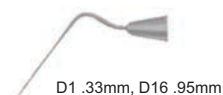

**1723**  
No. D11T

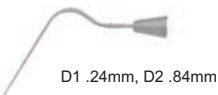

**1724**  
No. KR1



**1725**  
No. 25S

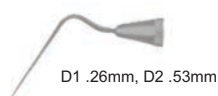

**1726**  
No. W1S



**1727**  
No. W2S

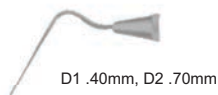

**1728**  
Lucks No.1



**1729**  
Lucks No.2



**1730**  
Lucks No.3



**1731**  
Lucks No.4

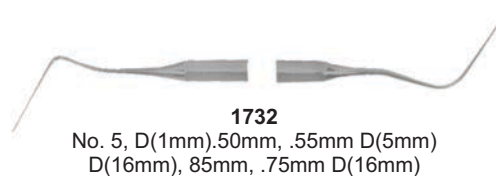

**1732**  
No. 5, D(1mm).50mm, .55mm D(5mm)  
D(16mm), 85mm, .75mm D(16mm)

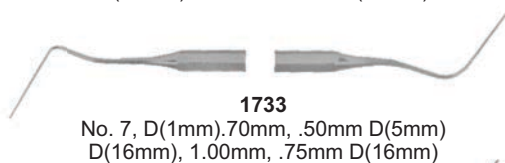

**1733**  
No. 7, D(1mm).70mm, .50mm D(5mm)  
D(16mm), 1.00mm, .75mm D(16mm)

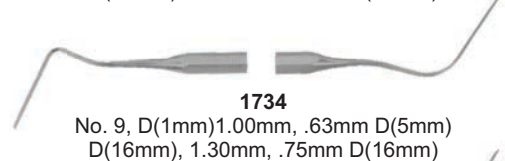

**1734**  
No. 9, D(1mm)1.00mm, .63mm D(5mm)  
D(16mm), 1.30mm, .75mm D(16mm)

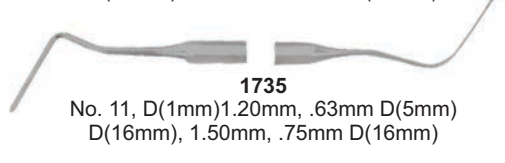

**1735**  
No. 11, D(1mm)1.20mm, .63mm D(5mm)  
D(16mm), 1.50mm, .75mm D(16mm)



**1736**  
No.1 (D1 .35mm, D16 .75mm)



**1737**  
No.2 D1 .55mm, D16 .85mm



**1738**  
No.3 D1 .85mm, D16 1.15mm



**1739**  
No.4 D1 1.00mm, D16 1.30mm

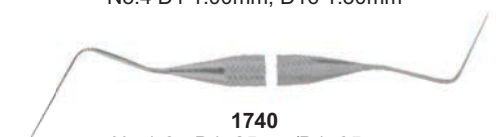

**1740**  
No.1-3 - D1 .25mm/D1 .35mm

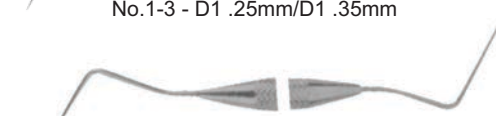

**1741**  
No.3-5 - D1 .35mm/D1 .55mm



**1742**  
No.5-7 - D1 .55mm/D1 .70mm

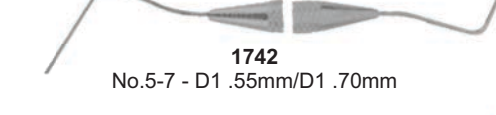

**1743**  
No.9-11 - D1 1.00mm/D1 1.20mm



1744  
No. 14

1745  
No. 17

1746  
No. 18

1747  
No. 19

1748  
No. 38/39

1749  
No. 61/62

1750  
No. 31L

1751  
No. 33L

1752  
No. 22

1753  
No. 3/6

1754  
No. 89/92

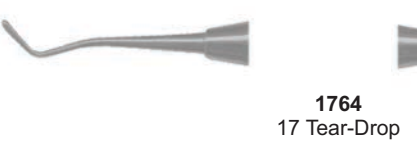
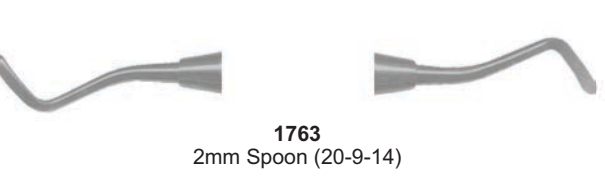
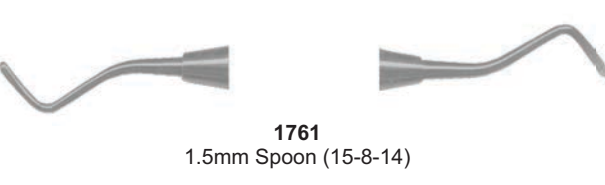
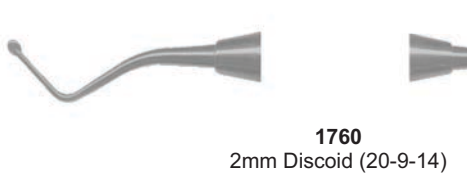
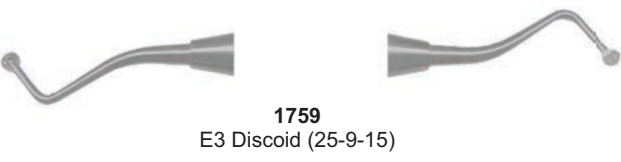
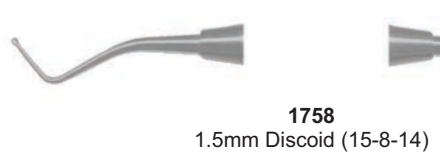
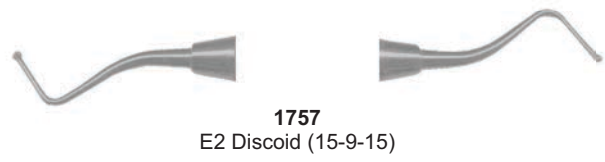
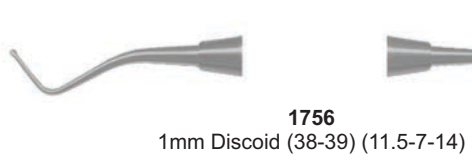
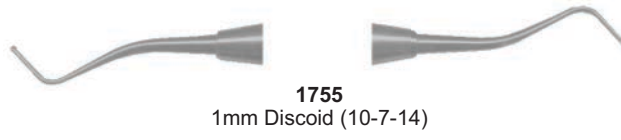

Excavators



**1768**  
31L



**1769**  
31W



**1770**  
33L



**1771**  
32L



Explorers / Probes



**1772**  
G16D-L



**1773**  
Explorer No.2



**1774**  
Explorer No.16



**1775**  
16-23 Explorer



**1776**  
16-17 Explorer



**1777**  
DG16 Explorer



**1778**  
(Heavy DG-16)



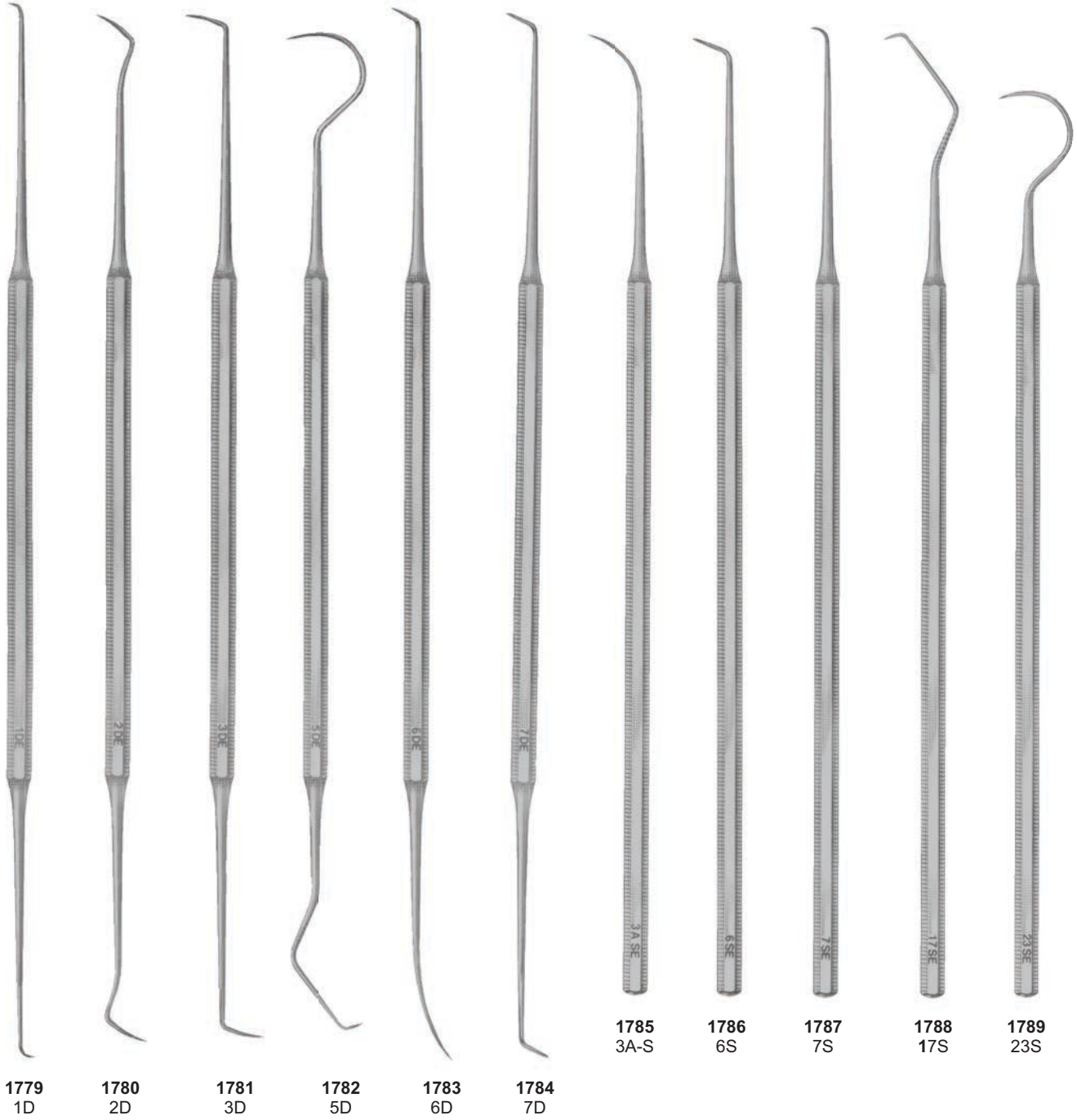

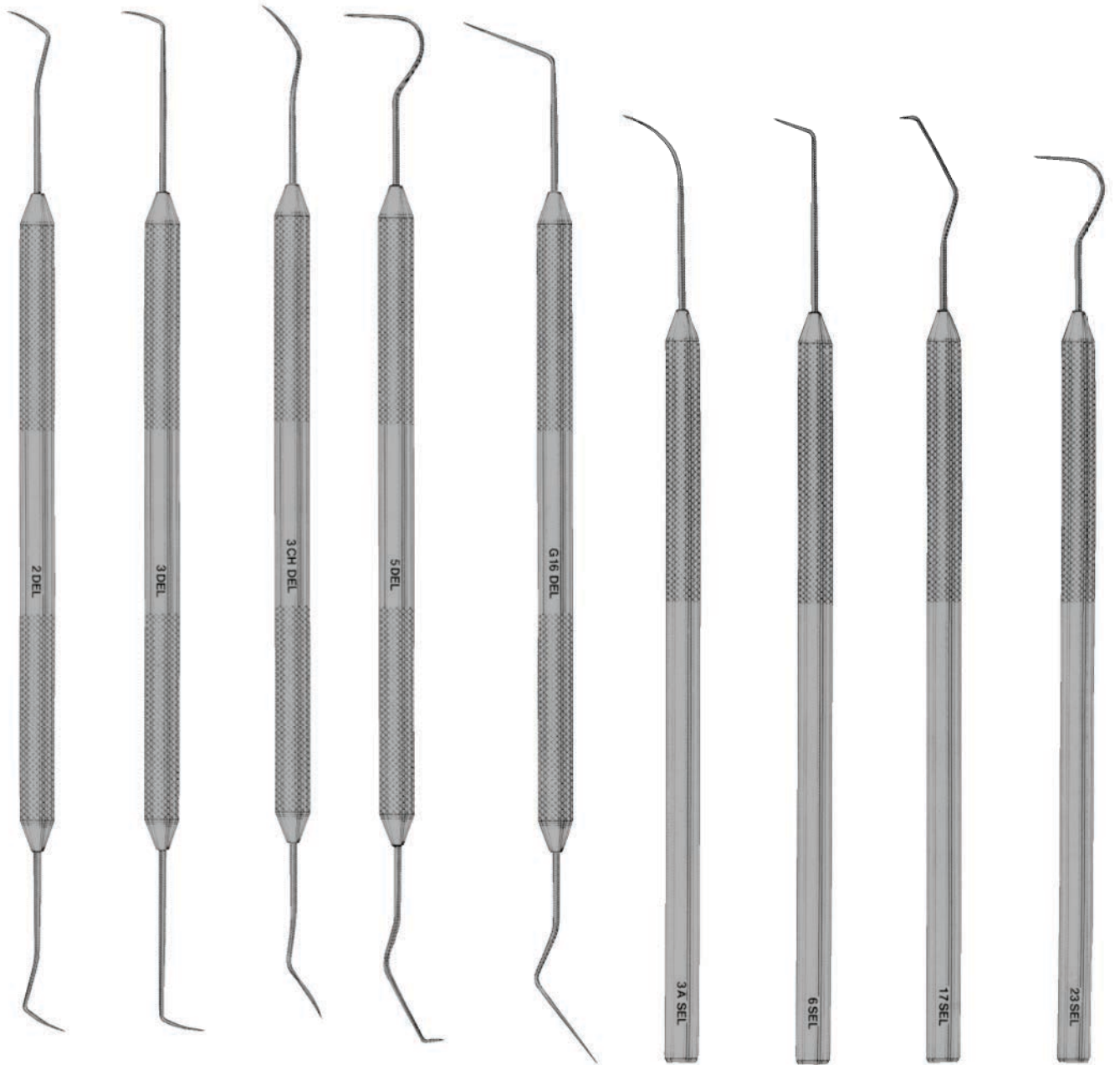

**1790**  
No. 2D-L

**1791**  
No. 3D-L

**1792**  
No. 3CHD-L

**1793**  
No. 5D-L

**1794**  
No. G16D-L

**1795**  
No. 3AS-L

**1796**  
No. 6S-L

**1797**  
No. 17S-L

**1798**  
No. 23S-L

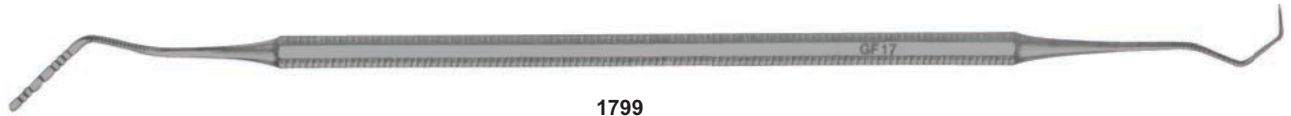

**1799**  
Gf17 Probe/Explorer



**1800**  
PE 1-23 Probe/Explorer



**1801**  
Probe 0 / 23 Explorer (fine)



**1802**  
Probe 1 / 23 Explorer



**1804**  
Probe 4 / 23 Explorer



**1803**  
Probe OW / 23 Explorer



**1805**  
Ball Tip Probe WHO / 23 Explorer

## PROBES



**1806**  
Gf18 Probe



**1807**  
"C" Probe



**1808**  
X2 Probe

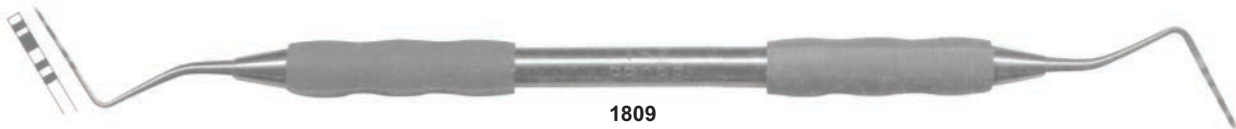

**1809**  
1-2 (Probe 2 end is flat)



**1810**  
1 UNC 15



**1811**  
4 SE

**CORD PACKERS**



**1812**

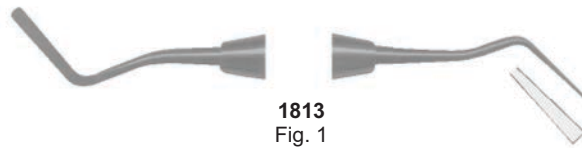

**1813**  
Fig. 1



**1814**  
Fig. 2



**1815**  
BLOOMFIELD  
Fig. 2 (off angle)



**1816**  
Fig. 1



**1817**  
CSI-1 (slightly serrated on ends)

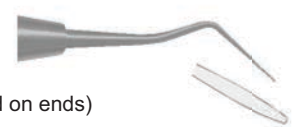

**HATCHETS**



**1818**  
1mm (10-7-14)



**1819**  
1.3mm (13-10-16)



**1820**  
1.5mm (15-8-14)

**HOES**

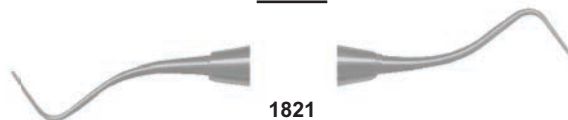

**1821**  
1mm (10-8-16)



**1822**  
UWH 18-19



**1823**  
UWH 16-18



**1824**  
UWH 20-21







**1825**  
P.K.Thomas 1



**1826**  
P.K.Thomas 2



**1827**  
P.K.Thomas 3



**1828**  
P.K.Thomas 4



**1829**  
P.K.Thomas 5



**7001**  
Gracey Currettes Set of 7 Pcs, Silicon Handle - Reuseable





**1830**  
BEHRMAN (Fig. 1)



**1831**  
BLACK (Fig. 1-2)



**1834**  
Hollenback No. 1 Plugger



**1832**  
MORQUETTE (Fig. 0/1)



**1835**  
Hollenback No. 2 Plugger



**1833**  
Black Action 11/12 Plugger



**1836**  
Hollenback No. 3 Plugger



**1837**  
Blacks 0-1 (1mm-1.5mm)



**1838**  
Blacks 1-2 (1.5mm-2.5mm)



**1843**  
.7mm-1mm



**1839**  
Bodkin 1 (.7mm-1mm)



**1844**  
1mm-1.5mm



**1840**  
Bodkin 2 (1.5mm-2mm)

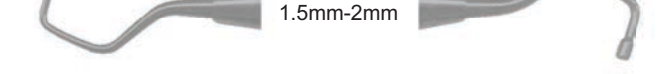

**1845**  
1.5mm-2mm



**1841**  
2.5mm-3mm

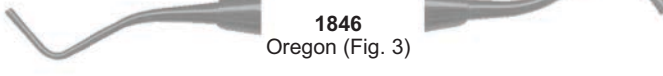

**1846**  
Oregon (Fig. 3)



**1842**  
Oregon 2



**1847**  
Oregon (Fig. 4)



**1848**  
UP 12



**1849**  
Applicator 1-2



**1850**  
Birtles Applicator Spatula



**1851**  
Birtles Applicator Spatula K

**Placement Instruments**

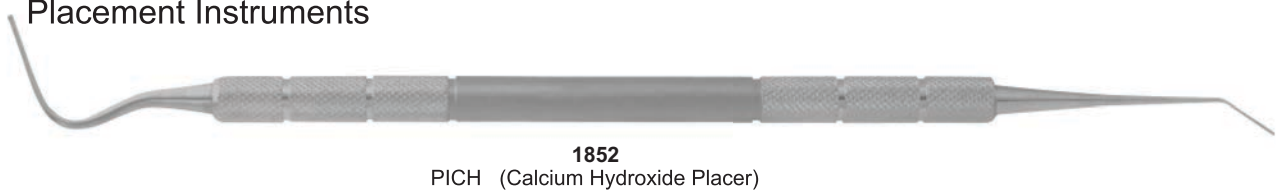

**Stopping Stoppers**

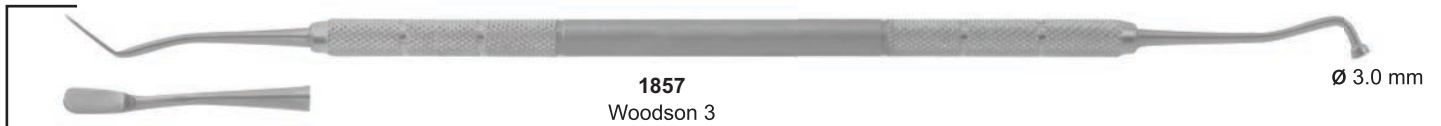
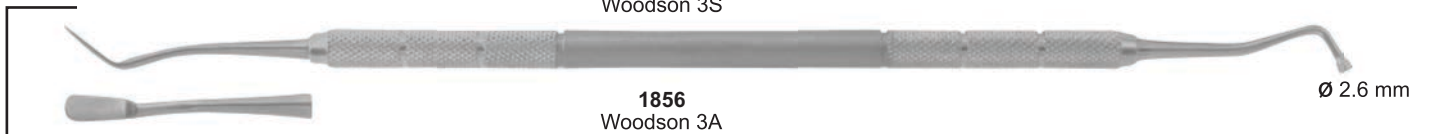

**Pluggers**

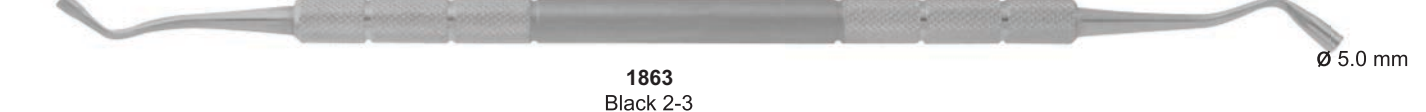
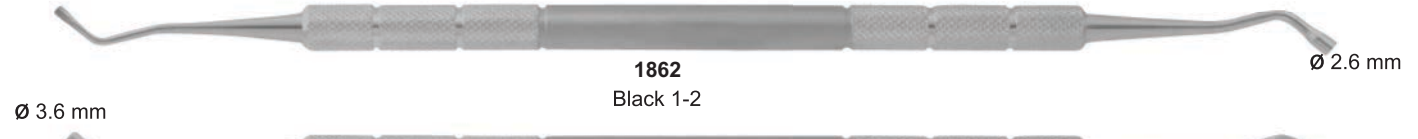
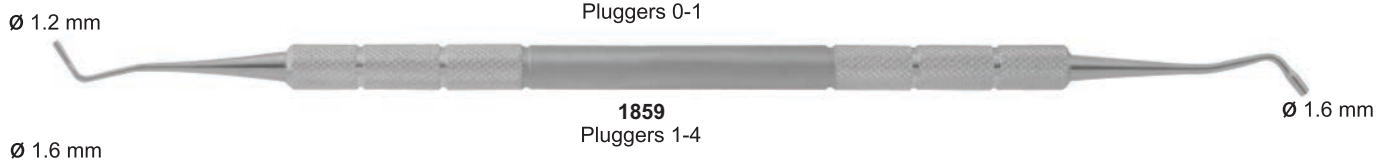

 Burnishers

 Carvers

 Chisels

 Composite Placements

 Filling Instruments

 Cures

 Disposable Instruments



# 03

SECTION





**1864**  
Fig. 1



**1865**  
Fig. 28/29

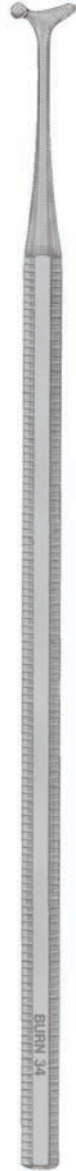

**1866**  
Fig. 34



**1867**  
Fig. 27/29

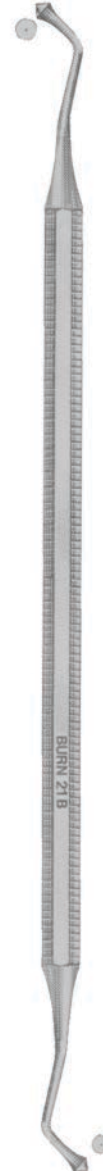

**1868**  
Fig. 21B



**1869**  
ACORN  
Fig. 21



1871  
Fig. 21B



1873  
Fig. 21C



1872  
Fig. 2-34



1874  
Fig. 26-28



1875  
Fig. 2-30



1876  
Fig. 26-30



1877  
Fig. 27-29



1878  
PKT 1



1879  
Fig. 27-30



1881  
Fig. 34T



1880  
PKT 2



1882  
Fig. 3



1883  
PKT 3



1884  
PFI 21



1885  
PKT 3P



1886  
Pitts Pedo 19



1887  
PKT 4



1888  
Pitts Pedo 18



1889  
PKT 5



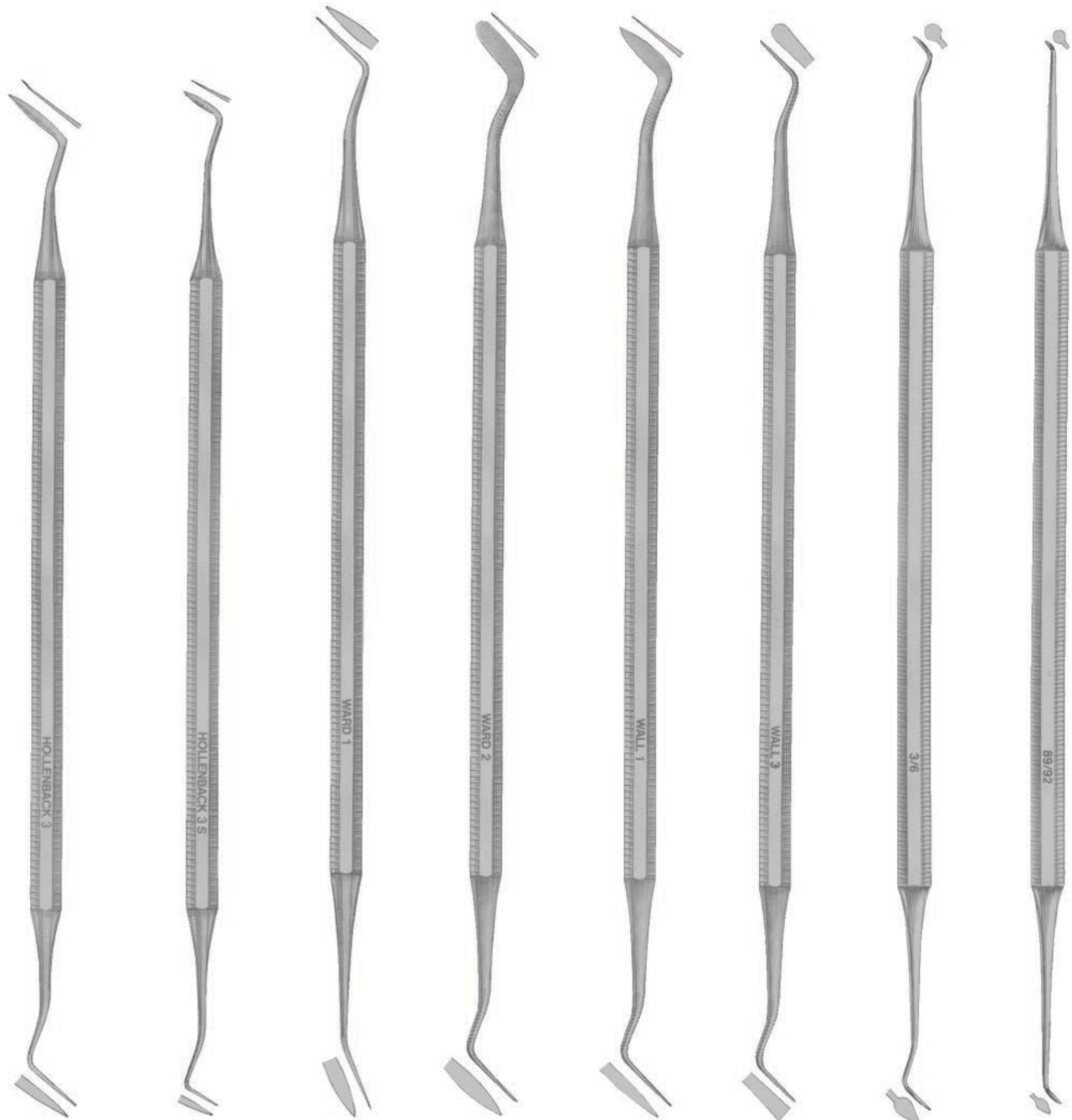

**1890**  
HOLLENBACK  
Fig. 3

**1891**  
HOLLENBACK  
Fig. 3S

**1892**  
WARD  
Fig. 1

**1893**  
WARD  
Fig. 2

**1894**  
WALL  
Fig. 1

**1895**  
WALL  
Fig. 3

**1896**  
Fig. 3/6  
Cleoid/Discoïd

**1897**  
Fig. 89/92  
Cleoid/Discoïd



**1898**  
1.5mm Cleoid Discoid (Shown with GTX Finish)



**1899**  
2mm Cleoid Discoid



**1900**  
GOLLOBIN  
Fig. 1



**1901**  
3mm Cleoid Discoid



**1902**  
HOLLENBACK  
Fig. 1/2



**1903**  
FRAHM  
Fig. 2-3 (off-angle)



**1904**  
HOLLENBACK  
Fig. 3



**1905**  
Interproximal 1



**1906**  
THOMPSON (Fig. 3)  
(½ Hollenback Hoe & Wall 3)



**1907**  
Interproximal 1



**1908**  
THOMPSON (Fig. 5)  
(½ Hollenback Hoe & Tanner 5)



**1909**  
Baum Interproximal



**1910**  
THOMPSON (Fig. 8)  
(3mm Cleoid & Wall 3)



**1911**  
Sho A Carver



**1912**  
THOMPSON (Fig. 9)  
(Hollenback 3 & Wall 3)



**1913**  
Thompson 2



**1914**  
WARD  
Fig. 2







**1915**  
Composite Interproximal



**1916**  
TANNER  
Fig. 5



**1917**  
TANNER  
Fig. 6



**1920**  
University of Minnesota  
Fig. 1



**1921**  
University of Minnesota  
Fig. 2



**1918**  
THARP  
Fig. 1



**1919**  
THOMPSON  
Fig. 1



**1922**  
UPR  
Fig. 1



**1923**  
WALL  
Fig. 3

## Contour Carbide Carvers - Finishing



**1924**  
Contour Carbide (Fig. 1-2)



**1925**  
Cleoid Discoid



**1926**  
Contour Carbide (Fig. 10-11)

## Chisels



**1927**  
1.5mm Bin-Angle (15-8-8)



**1928**  
1.5mm Straight (15)



**1930**  
1.5mm Wedelstaedt (15-15-3)



**1929**  
1mm Wedelstaedt (10-15-3)



**1931**  
2mm Wedelstaedt (20-15-3)

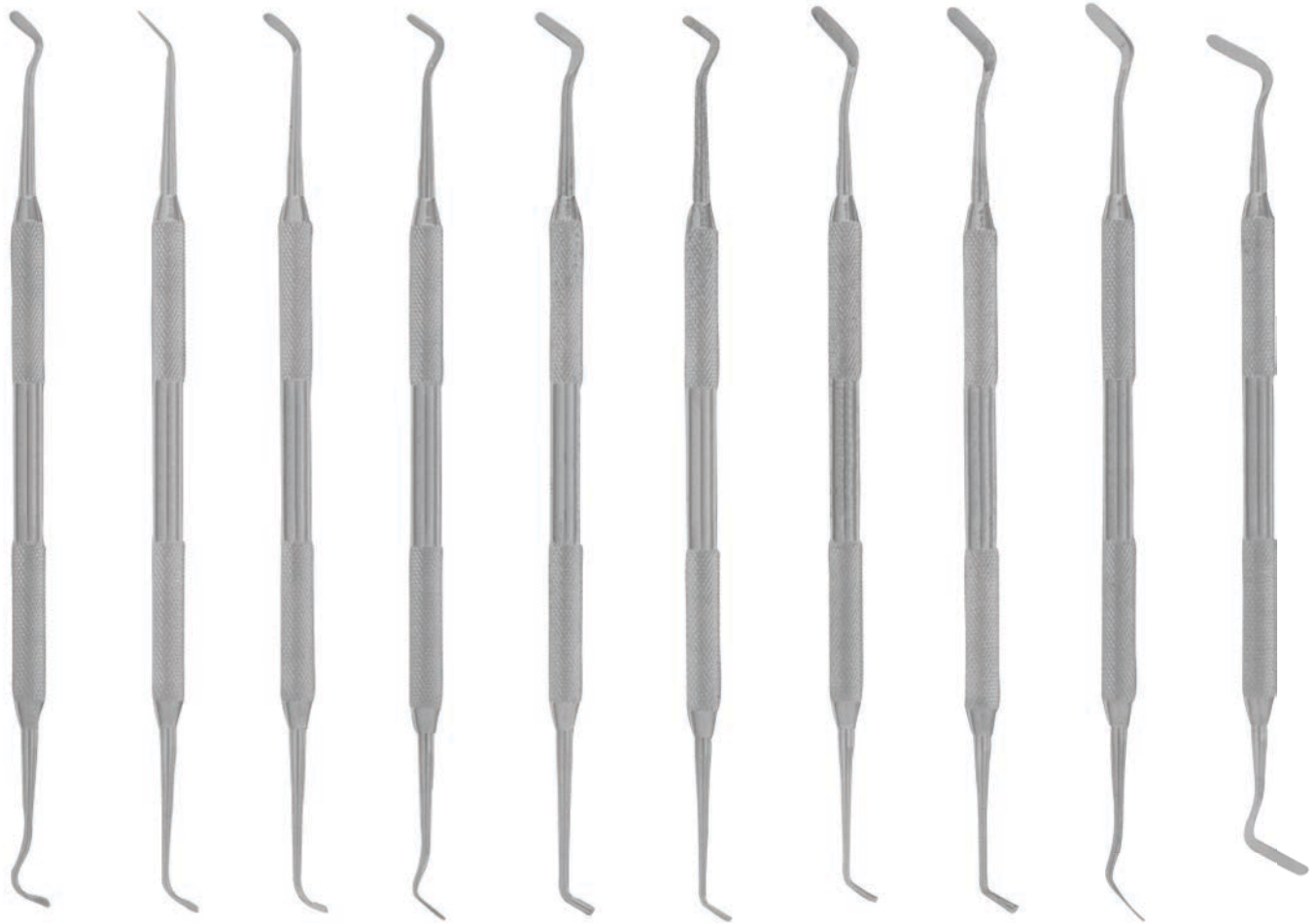

**1932**  
F-Type 1

**1933**  
F-Type 2

**1934**  
F-Type 3

**1935**  
F-Type 4

**1936**  
F-Type 5

**1937**  
F-Type 6

**1938**  
G-Type 1

**1939**  
G-Type 2

**1940**  
G-Type 3

**1941**  
G-Type 4

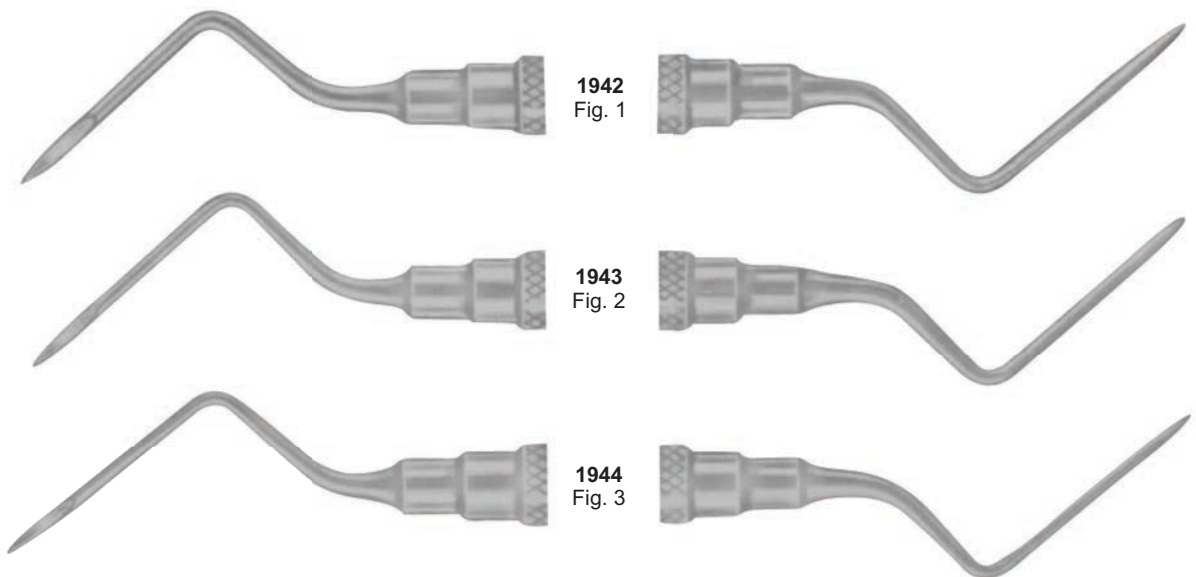

**1942**  
Fig. 1

**1943**  
Fig. 2

**1944**  
Fig. 3



1945  
Fig. 2



1946  
Fig. 3 (off-set blade)



1947  
Fig. 4



1948  
Fig. 5

1954  
Fig.12



1949  
Fig. 6



1950  
Fig.7



1951  
Fig.8

1955  
Fig.15



1952  
Fig.9



1953  
Fig.11



1956  
JORDAN  
Fig. 2



1957  
FREEDMAN  
Fig. 1



1958  
FREEDMAN  
Fig. 2



1959  
FREEDMAN  
Fig. 3



1960  
Dr. Dan



1961  
SIMON  
Fig. 2



1963  
K-Type 2



1964  
K-Type 3



1965  
K-Type 4



1966  
K-Type 5



1967  
K-Type 6 Carbide

## K - Type

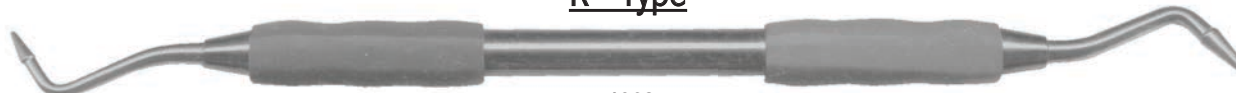

1962  
K-Type 1





1968  
No.3

1969  
No.4

1970  
No.5

1971  
LADMORE  
Fig. 3

1972  
WOODSON  
Fig. 1

1973  
WOODSON  
Fig. 2

1974  
WOODSON  
Fig. 3

1975  
W-3

1976  
Gregg  
4/5



1977  
Fig. 5-7



1978  
Fig.1



1979  
Fig. 3



1983  
GLICK  
Fig.1



1980  
Fig. 4

1984  
P8



1985  
WOODSON  
Fig. 1



1981  
Fig. 5-7



1982  
Fig. 8A



1986  
WOODSON  
Fig. 2



1987  
WOODSON  
Fig. 3





**1988**  
GRACEY  
GC 1-2



**1989**  
GRACEY  
GC 3-4



**1990**  
GRACEY  
GC 5-6



**1991**  
GRACEY  
GC 7-8



**1992**  
GRACEY  
GC 9-10



**1993**  
GRACEY  
GC 11-12



**1994**  
GRACEY  
GC 13-14

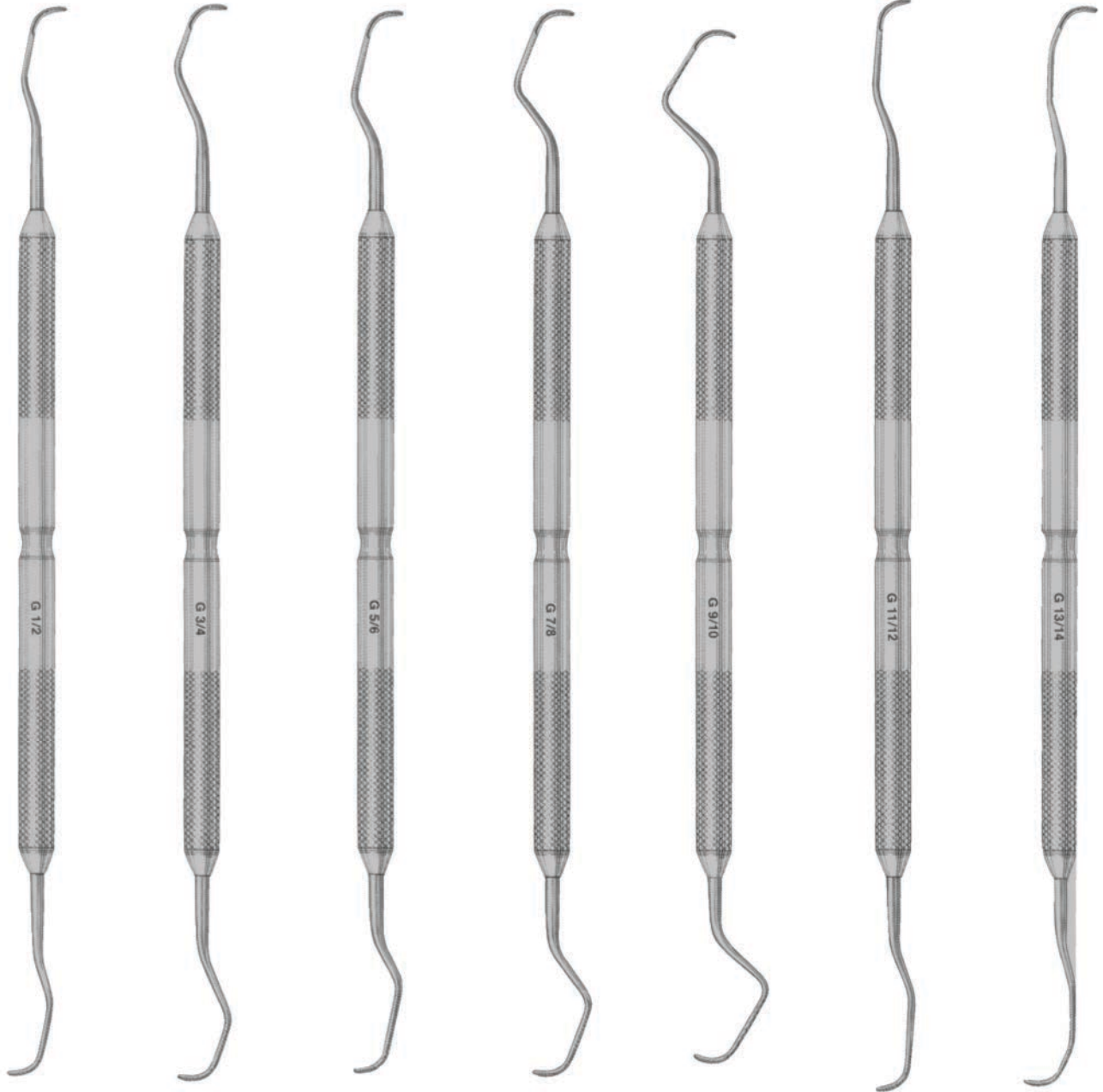

**1995**  
G1-2

**1996**  
G3-4

**1997**  
G5-6

**1998**  
G7-8

**1999**  
G9-10

**2000**  
G11-12

**2001**  
G13-14



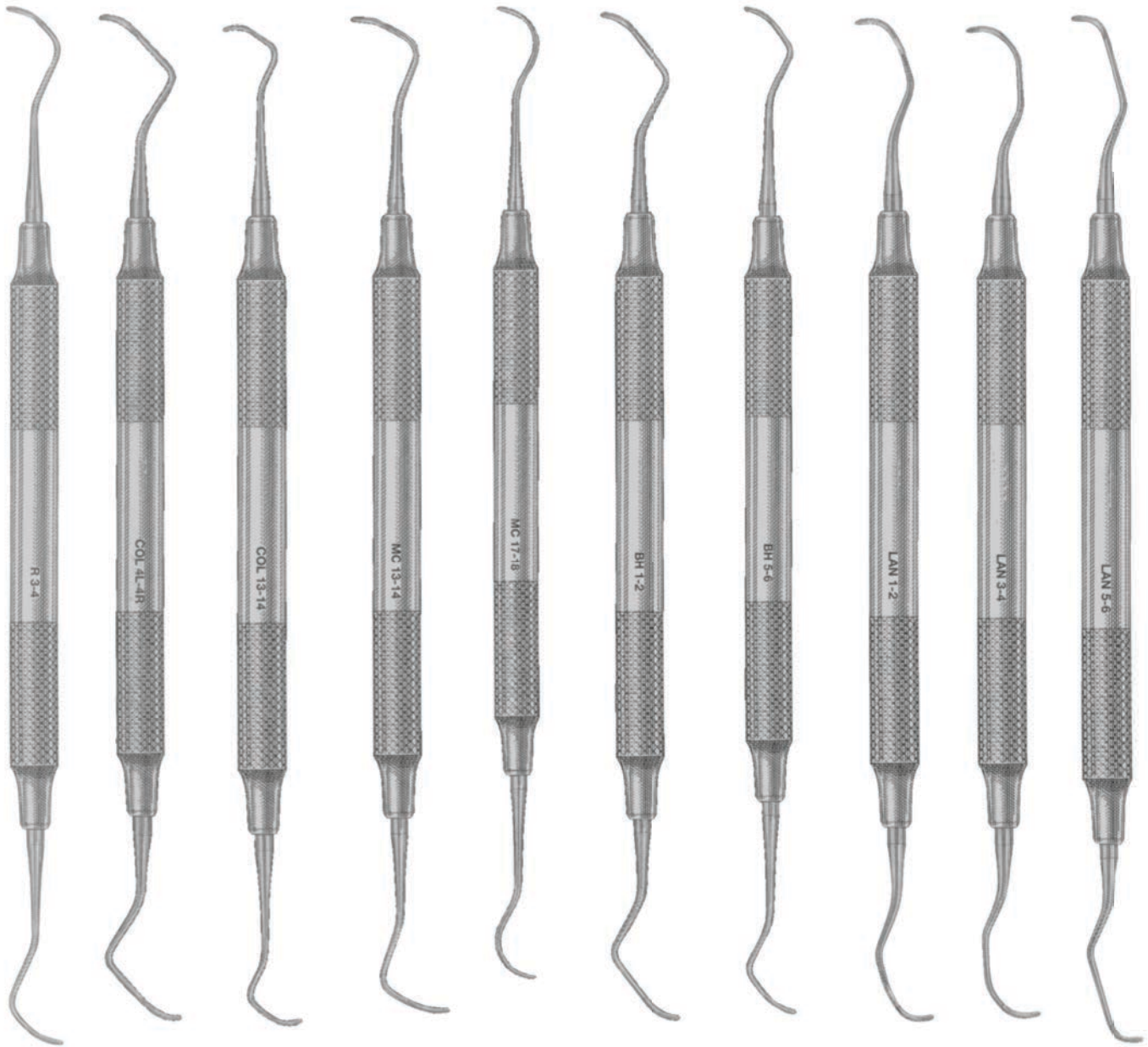

**2002**  
RULE  
3-4

**2003**  
COLUMBIA  
4R-4L

**2004**  
COLUMBIA  
13-14

**2005**  
MCCALLS  
13-14

**2006**  
MCCALLS  
17-18

**2007**  
BARNHART  
1-2

**2008**  
BARNHART  
5-6

**2009**  
LANGER  
1-2

**2010**  
LANGER  
3-4

**2011**  
LANGER  
5-6



COLUMBIA CURETTES



2012  
4L-4R

2013  
13-14

2014  
2L-2R

MCCALLS CURETTES



2015  
13-14

2016  
13S-14S

2017  
17-18

2018  
17S-18S

GOLDMAN FOX



**2019**  
GF1 Universal Scaler



**2020**  
GF2 Curette



**2021**  
GF3 Curette



**2022**  
GF4 Curette



**2023**  
GF5 Hoe



**2024**  
GF6 Hoe

GOLDMAN FOX



**2025**  
GF 7 Knife



**2026**  
GF 8 Spear Knife



**2027**  
GF 9 Knife Scaler



**2028**  
GF 11 Spear Knife



**2029**  
GF 21 Sharp Spoon /  
Small Scaler



**2030**  
Kirkland 15 / 16



**2031**  
Ordan 1 / 2



**2032**  
Buck 3 / 4

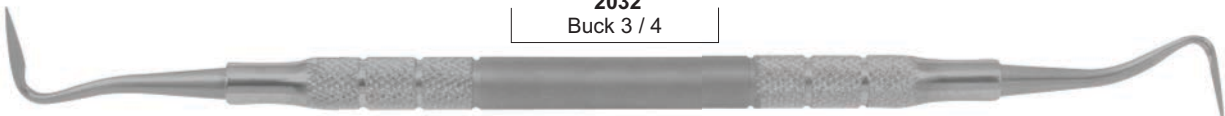

**2033**  
Buck 5 / 6



**2034**  
Goldman-Fox 7



**2035**  
Goldman-Fox 8



**2036**  
Goldman-Fox 9



**2037**  
Goldman-Fox 11

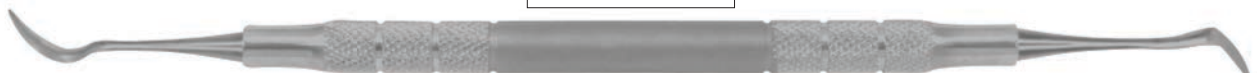

**2038**  
CK 3 (Crane)

## Interproximal Files

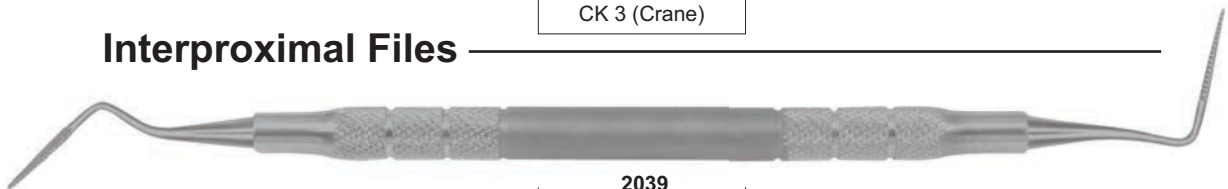

**2039**  
Sugarman 1S-2S



**2040**  
Sugarman 3S-4S



**2041**  
Schluger 9 -10



**2042**  
Buck 11 - 12



**2043**  
COLUMBIA (2L-2R)



**2044**  
MCCALL (13-14)



**2045**  
MCCALL (17S-18S)

### Root Planning Curettes



**2046**  
Root Plane (1-2)



**2047**  
Root Plane (5-6)



**2049**  
Root Plane (11-12)



**2048**  
Root Plane (7-8)

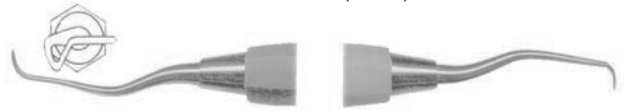

**2050**  
Root Plane (13-14)



**2051**  
Petite (1-2)



**2052**  
Petite (11-12)



**2053**  
Petite (5-6)



**2054**  
Petite (13-14)



2055  
BARNHART (1-2)



2056  
BARNHART (5-6)

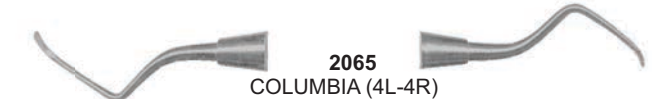

2065  
COLUMBIA (4L-4R)



2057  
GRACEY (1-2)



2066  
COLUMBIA (13-14)



2058  
GRACEY (3-4)



2067  
LANGER (1-2)



2059  
GRACEY (5-6)



2068  
LANGER (3-4)



2060  
GRACEY (7-8)

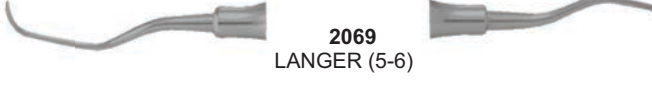

2069  
LANGER (5-6)



2061  
GRACEY (9-10)

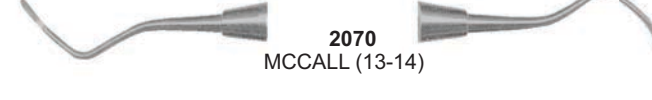

2070  
MCCALL (13-14)



2062  
GRACEY (11-12)

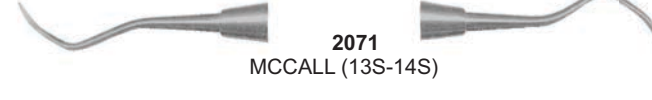

2071  
MCCALL (13S-14S)



2063  
GRACEY (13-14)

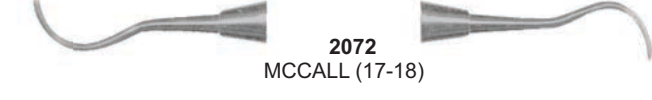

2072  
MCCALL (17-18)



2064  
GRACEY (2L-2R)

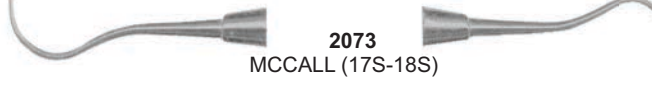

2073  
MCCALL (17S-18S)



2074  
RULE (3-4)



- ⟨☞⟩ Cement Instruments
- ⟨☞⟩ Bone Chisels
- ⟨☞⟩ Spatulas
- ⟨☞⟩ Bone Mallets
- ⟨☞⟩ Knives
- ⟨☞⟩ Crown Remover
- ⟨☞⟩ Bone Curettes & Files
- ⟨☞⟩ Implant Instruments



# 04

SECTION



Silicon Handles-Reusable

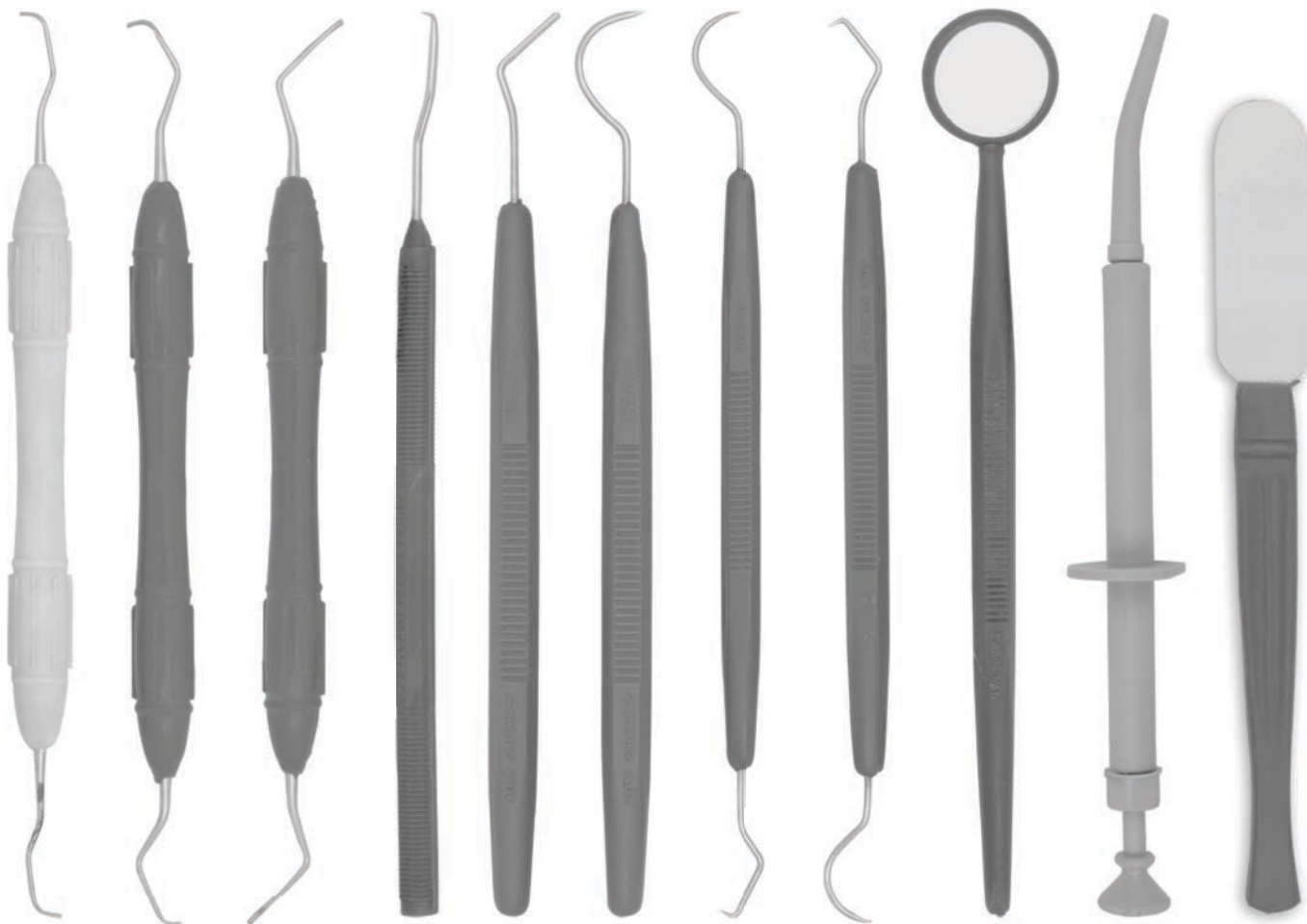

2075

2076

2077

2078

2079

2080

2081

2082

2083

2084

2085



2086



2087



2088



2089



2090



Comfort Grip  
Vinyl - Covered Insulating Handles



P.K. THOMAS

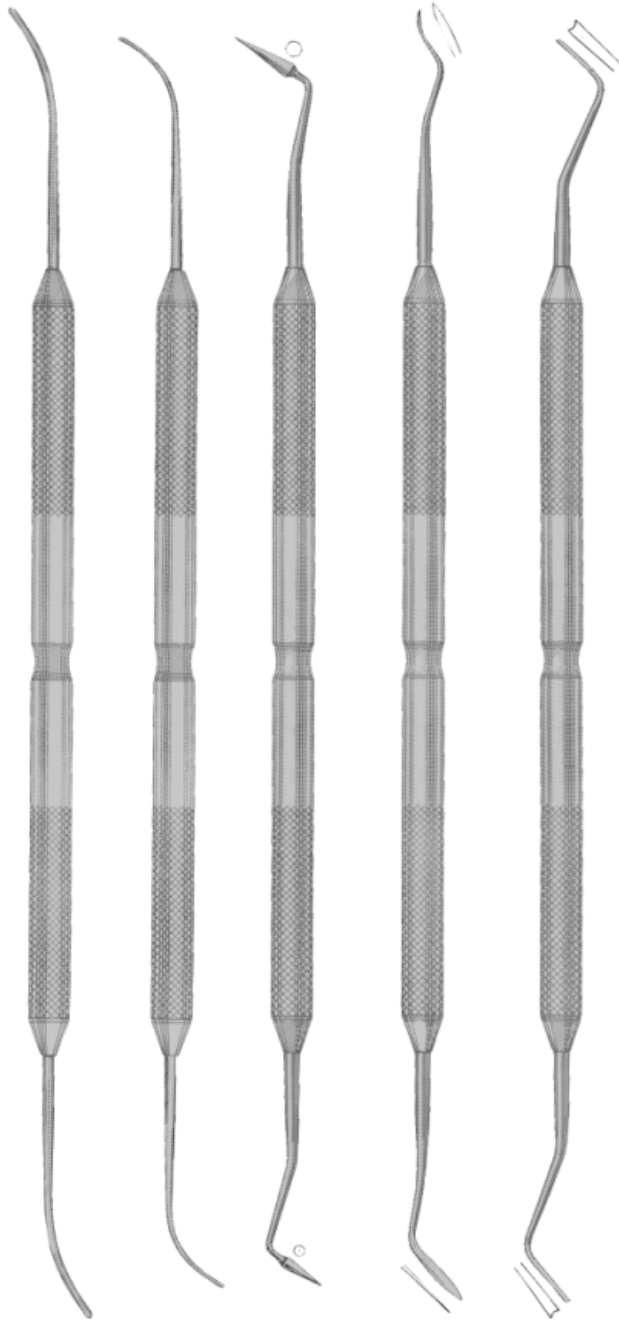

2101 PKT 1    2102 PKT 2    2103 PKT 3    2104 PKT 4    2105 PKT 5

Set of 5 instruments

WAX CARVERS

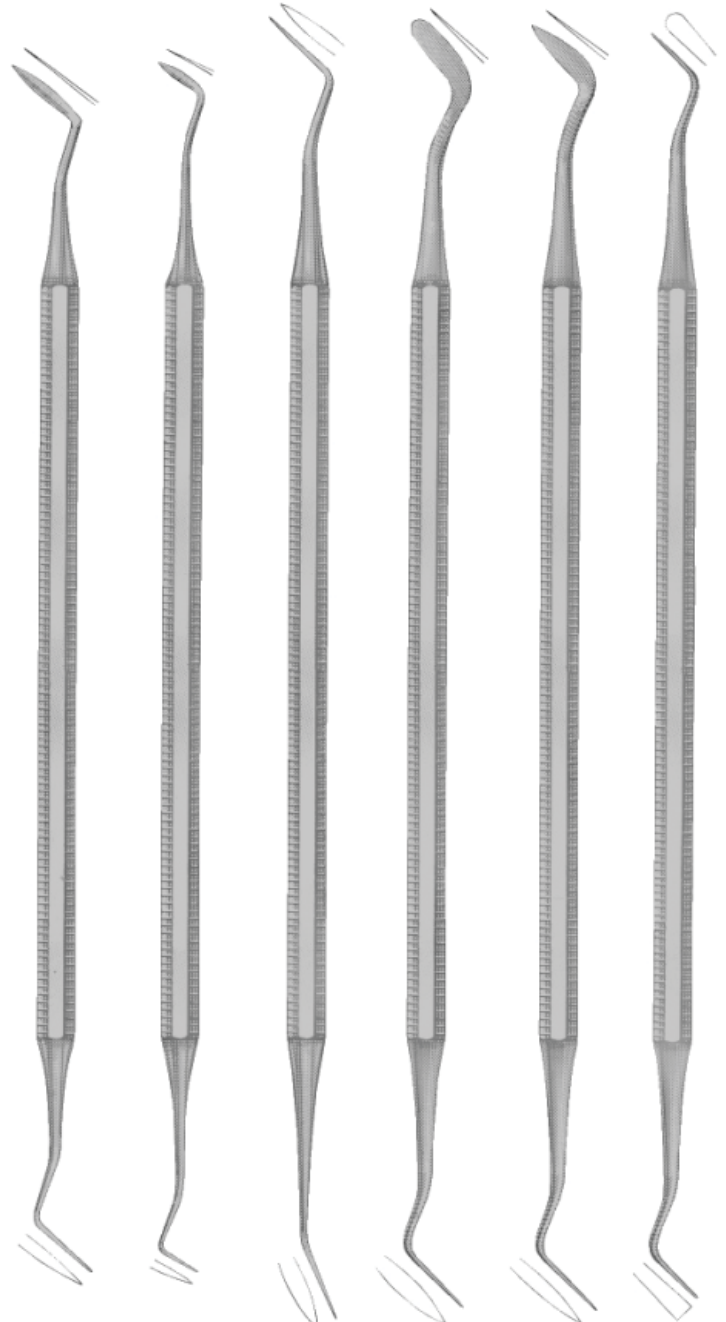

2106 Hollenback 3    2107 Hollenback 3S    2108 WARD 1    2109 WARD 2    2110 WALL 1    2111 WALL 3



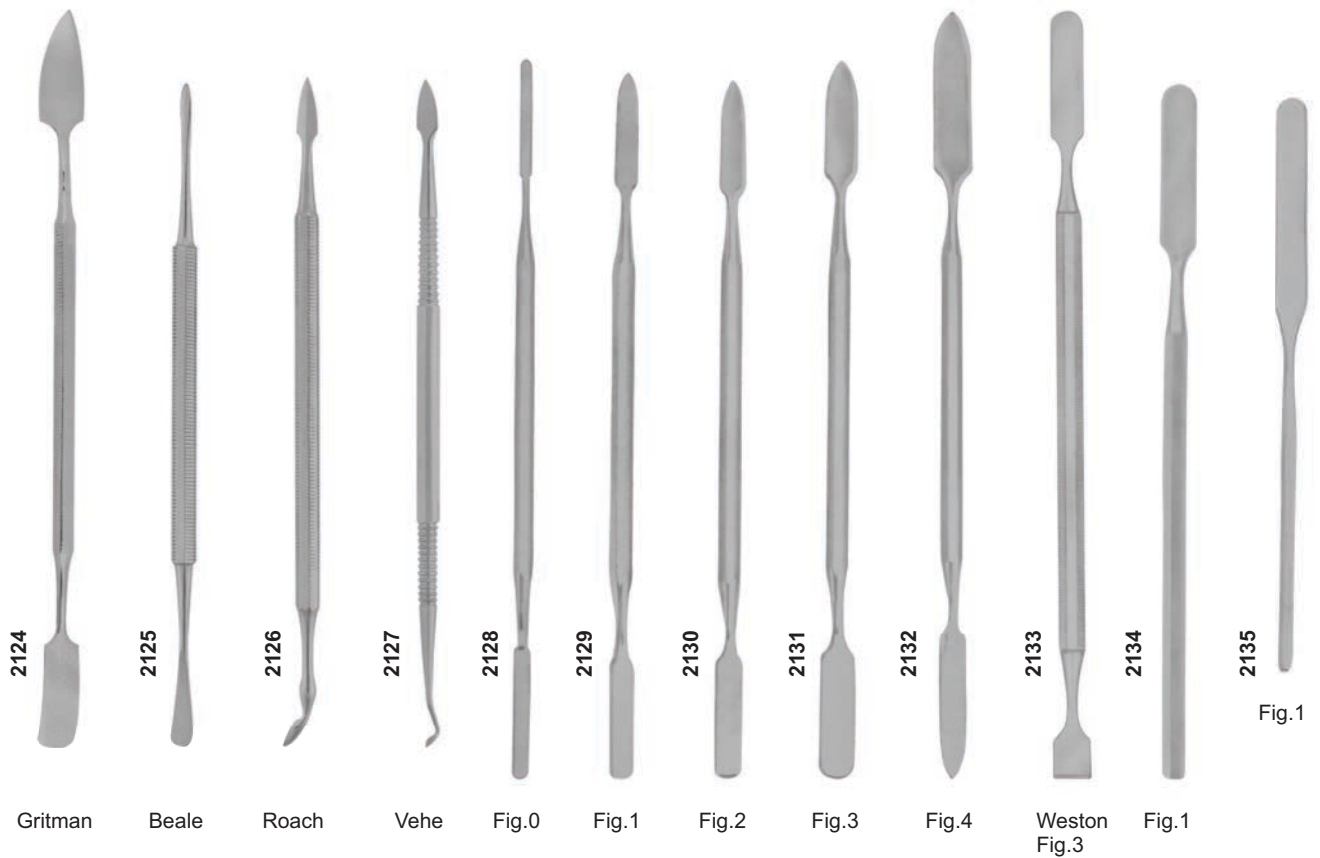
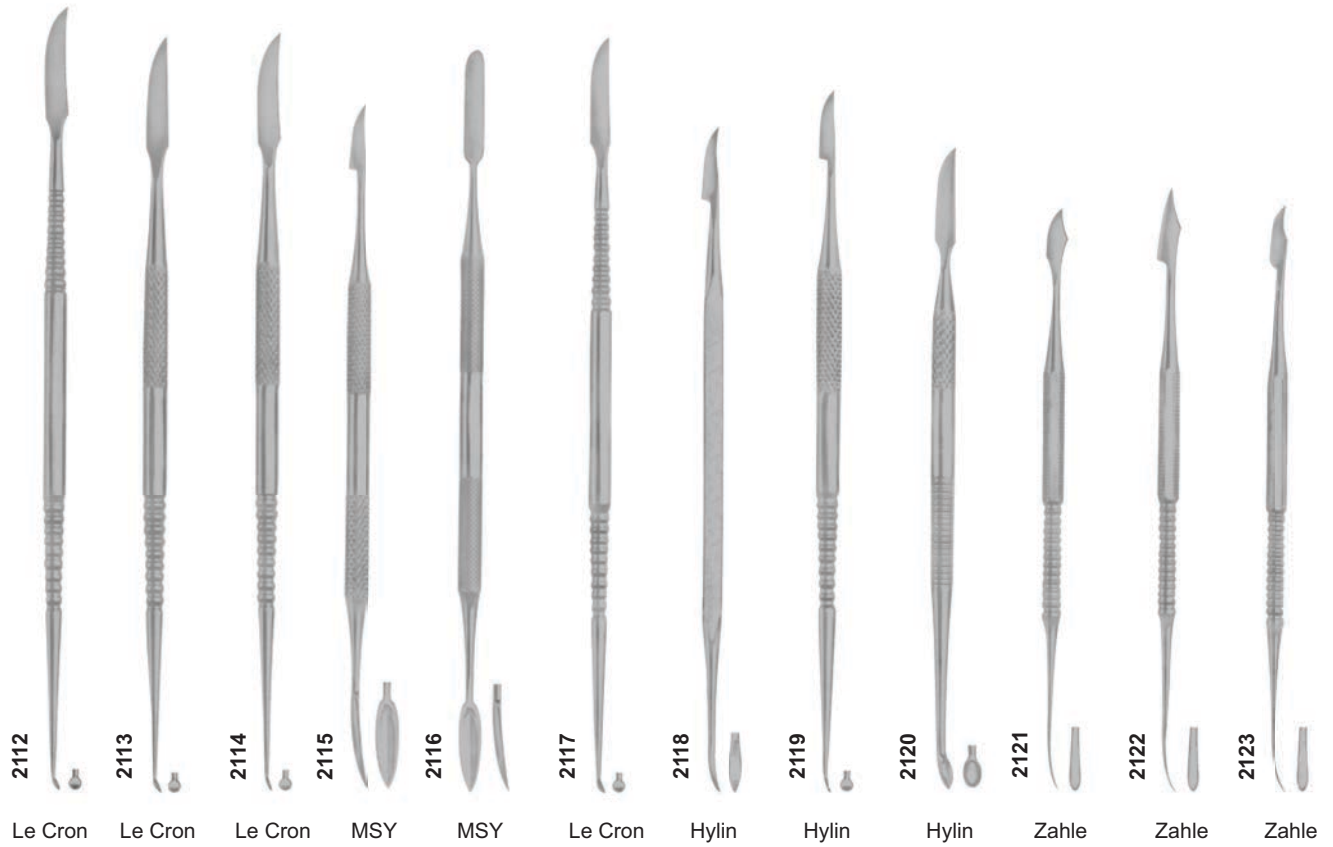

WAX & PORCELAINE CARVERS



**2136**  
LECRON  
Inlay

**2137**  
REEVES

**2138**  
VEHE  
Wax

**2139**  
ROACH  
Wax

WAX SPATULAS

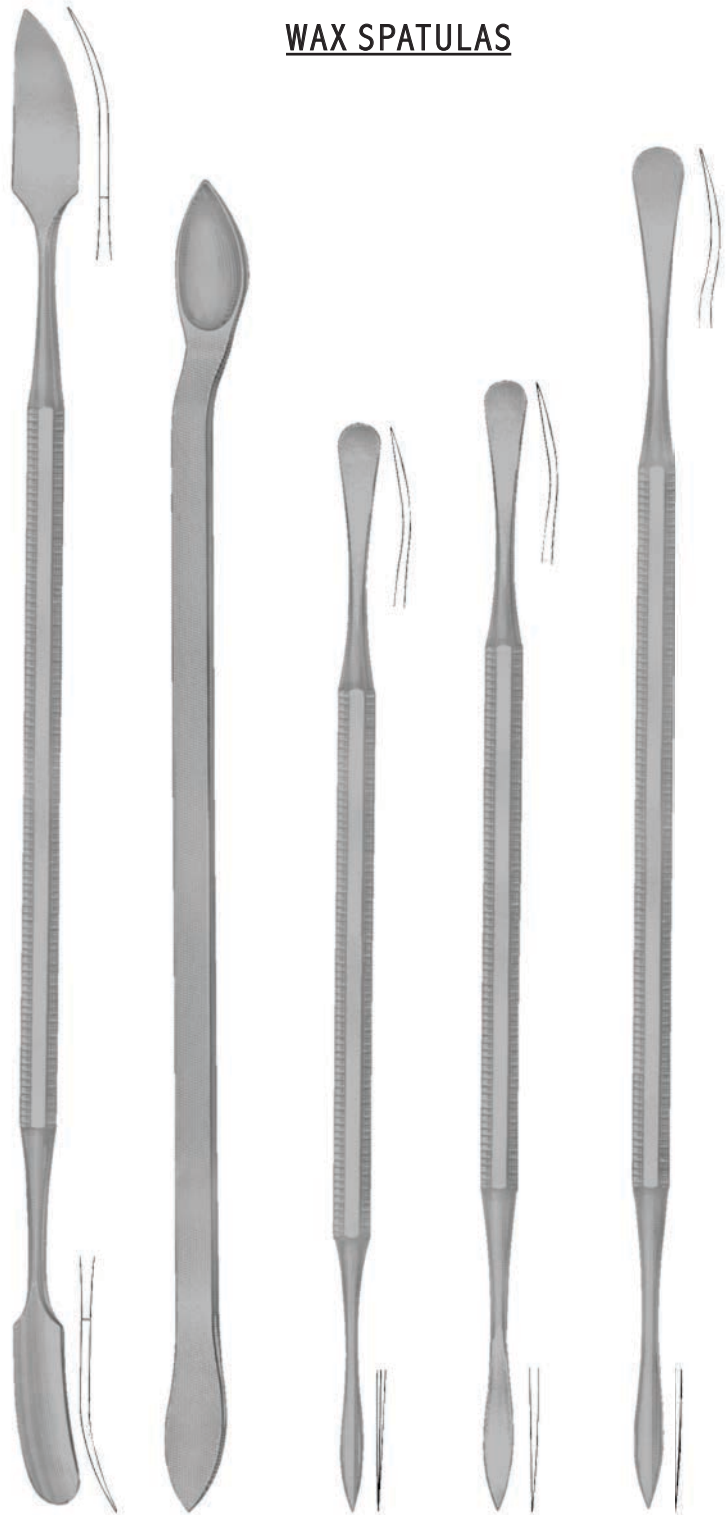

**2140**  
W-31

**2141**  
W-5

**2142**  
W-7

**2143**  
W-7A

**2144**  
W-7G



**2145**  
AGATHE



**2146**  
C-7



**2147**  
C-5



**2148**  
C-313



**2149**  
C-24A Rigid



**2150**  
C-24 Flexible



**2151**  
C-24 Flexible



**2152**  
24



**2153**  
A6



**2154**  
7 Wax



**2155**  
26



**2156**  
All Metal Spatulas with High Polish  
Stainless Steel Blade



**2157**  
31

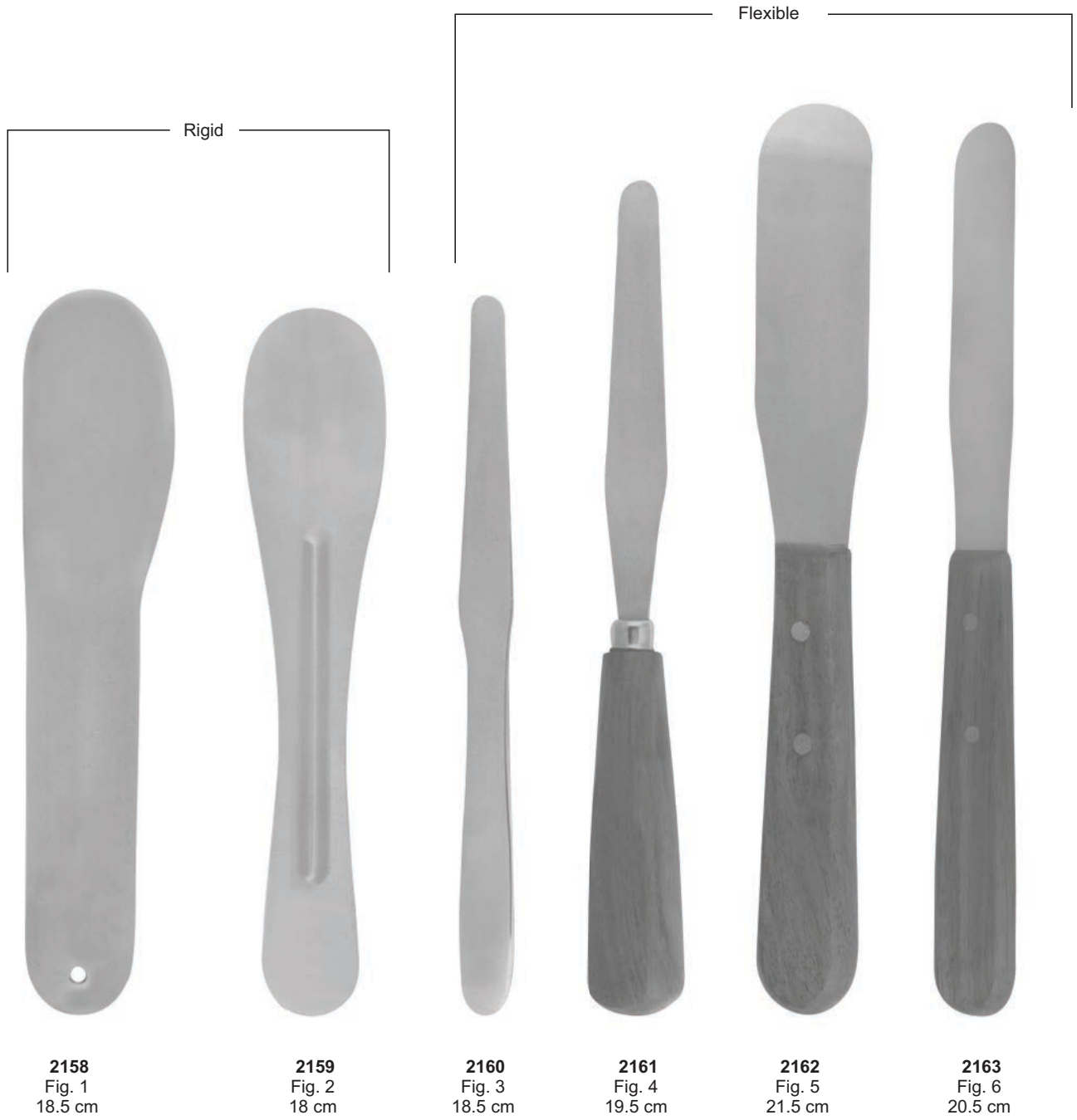



**2164**  
Fig. 7  
19.5 cm



**2165**  
Fig. 8  
20 cm



**2166**  
Fig. 9  
22.5 cm

FILES

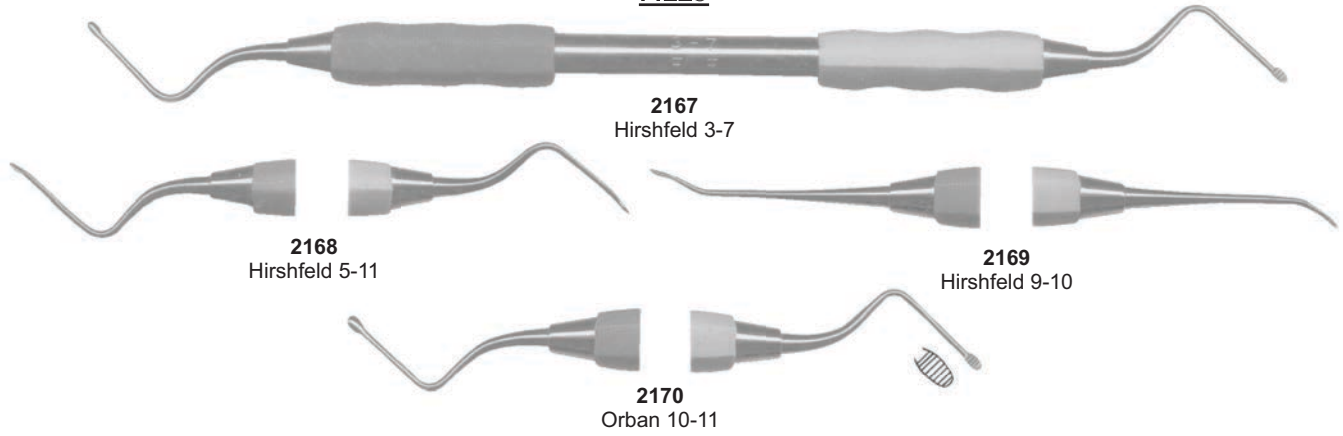

HOES

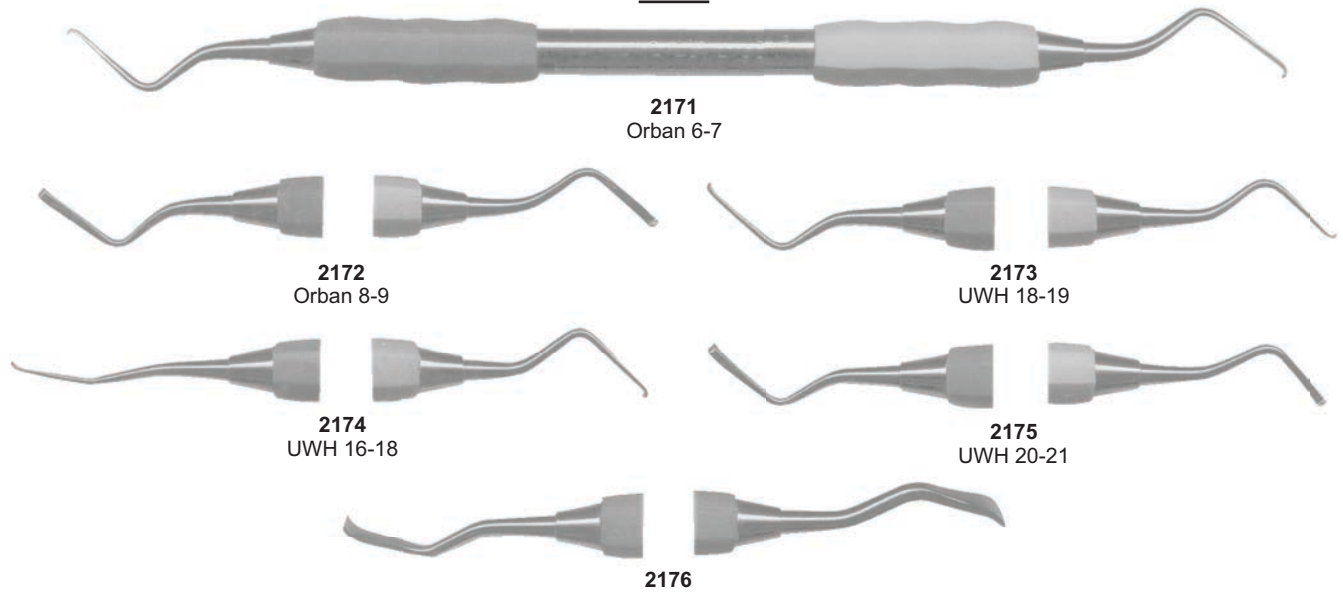

KNIVES

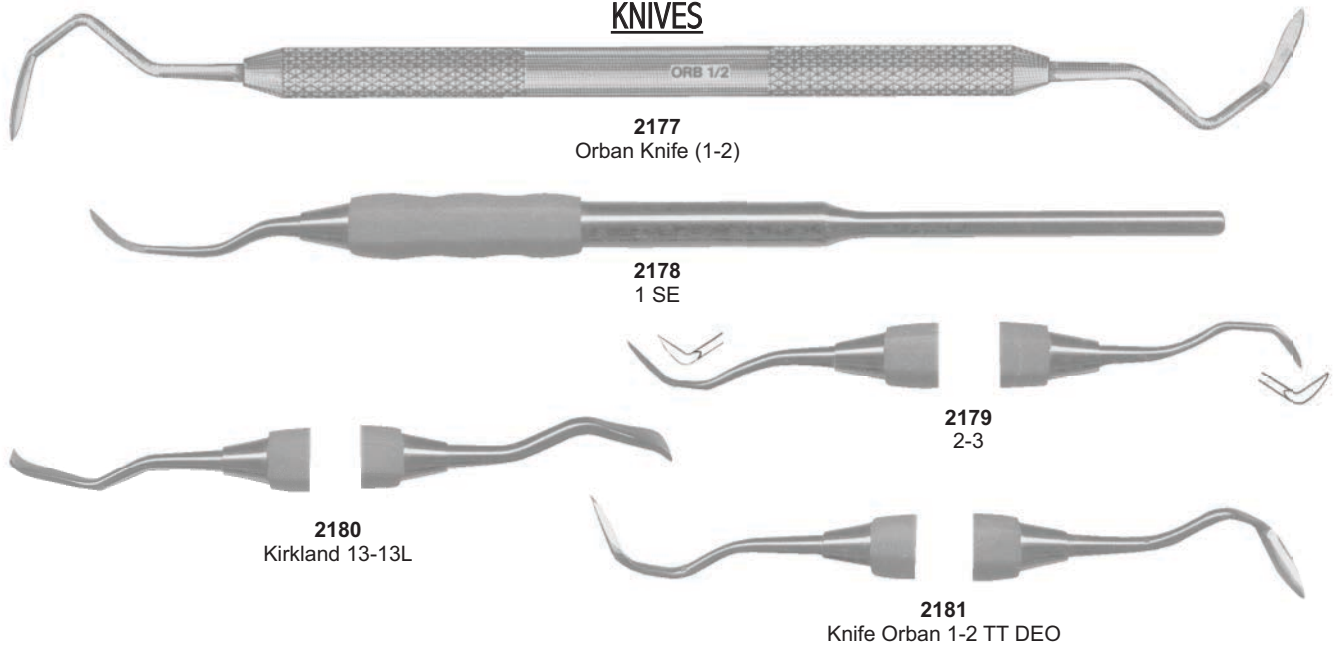





**2182**  
Fahnenstock  
Fig. 1  
12,5cm

**2183**  
Fahnenstock  
Fig. 2  
17cm

**2184**  
Lessmann  
Fig. 1  
12,5cm

**2185**  
Lessmann  
Fig. 2  
17cm

**2186**  
Con scodellino  
Fig. 1  
12,5cm

**2187**  
Con scodellino  
Fig. 2  
17cm

**2188**  
Ermert

**2189**  
Ermert



**2190**  
18 cm  
7 1/8"



**2191**  
18 cm  
7 1/8"



**2192**  
17 cm  
6 3/4"  
Gritman



**2193**  
17 cm  
6 3/4"  
Medicon



**2194**  
Fig. 1  
17 cm



**2195**  
22 cm  
8 3/4"



**2196**  
22 cm  
8 3/4"



**2197**  
Gritman  
Fig. 2  
17 cm



**2198**  
Fig. 3  
16 cm



**2199**  
Fig. 4  
16 cm

## CRANE-KAPLAN



**2200**  
Ck1  
Pocket Marker

**2201**  
Ck2  
Pocket Marker

**2202**  
Knife

**2203**  
Dissector

**2204**  
Scaler

## OCHSENBEIN

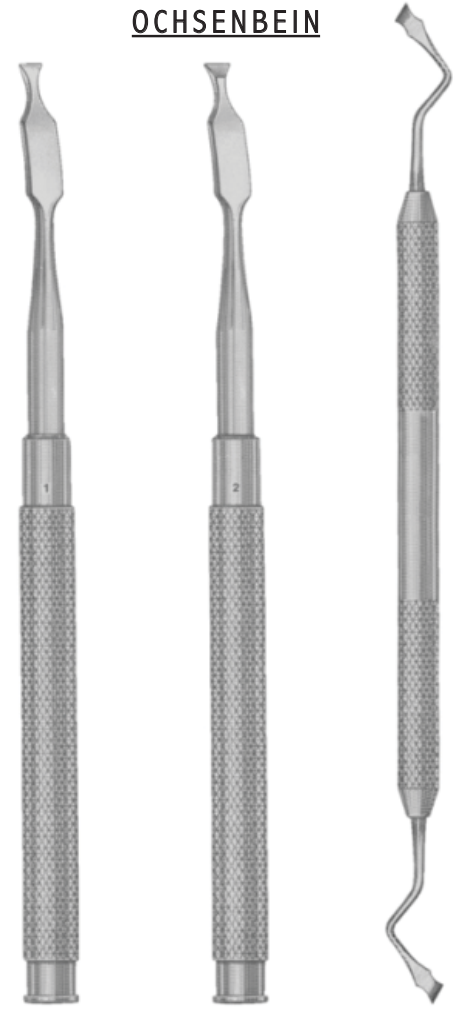

**2205**  
Ochsenbein  
Fig. 1

**2206**  
Ochsenbein  
Fig. 2

**2207**  
Ochsenbein  
Fig. 4

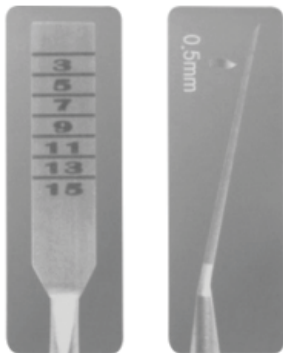

Split Chisel Set



**2208**  
Split Chisel  
6 mm Curved



**2209**  
Split Chisel  
6 mm Straight



**2210**  
Split Chisel  
4 mm Curved



**2211**  
Split Chisel  
4 mm Straight

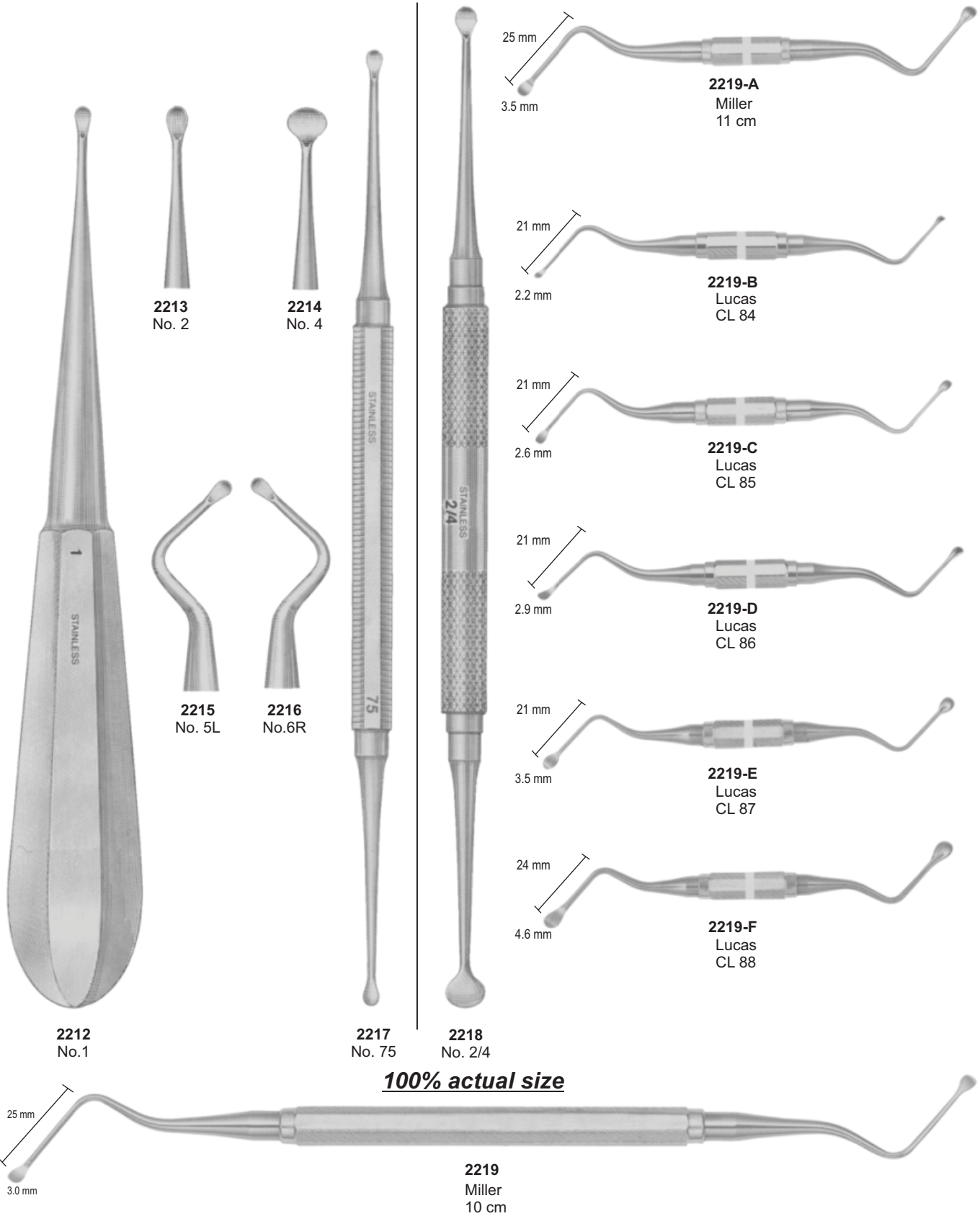

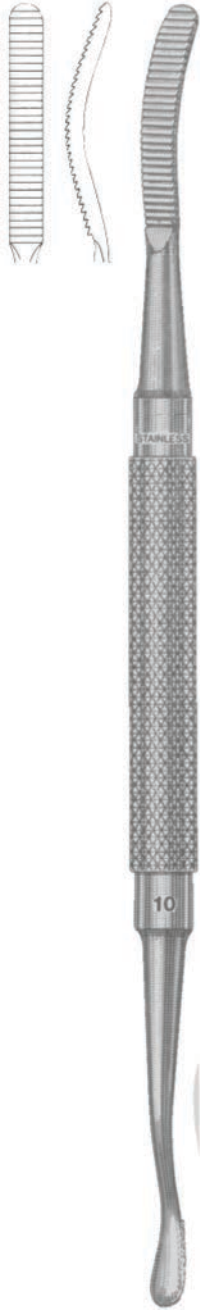

**2220**  
No. 10

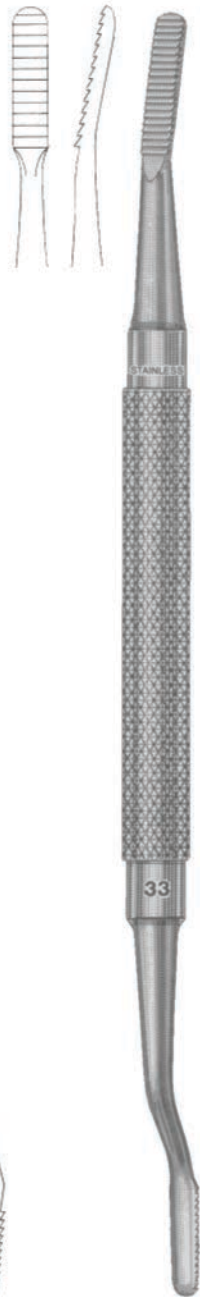

**2221**  
No. 33



**2222**  
MILLER  
No. 64



**2223**  
MILLER  
No. 64

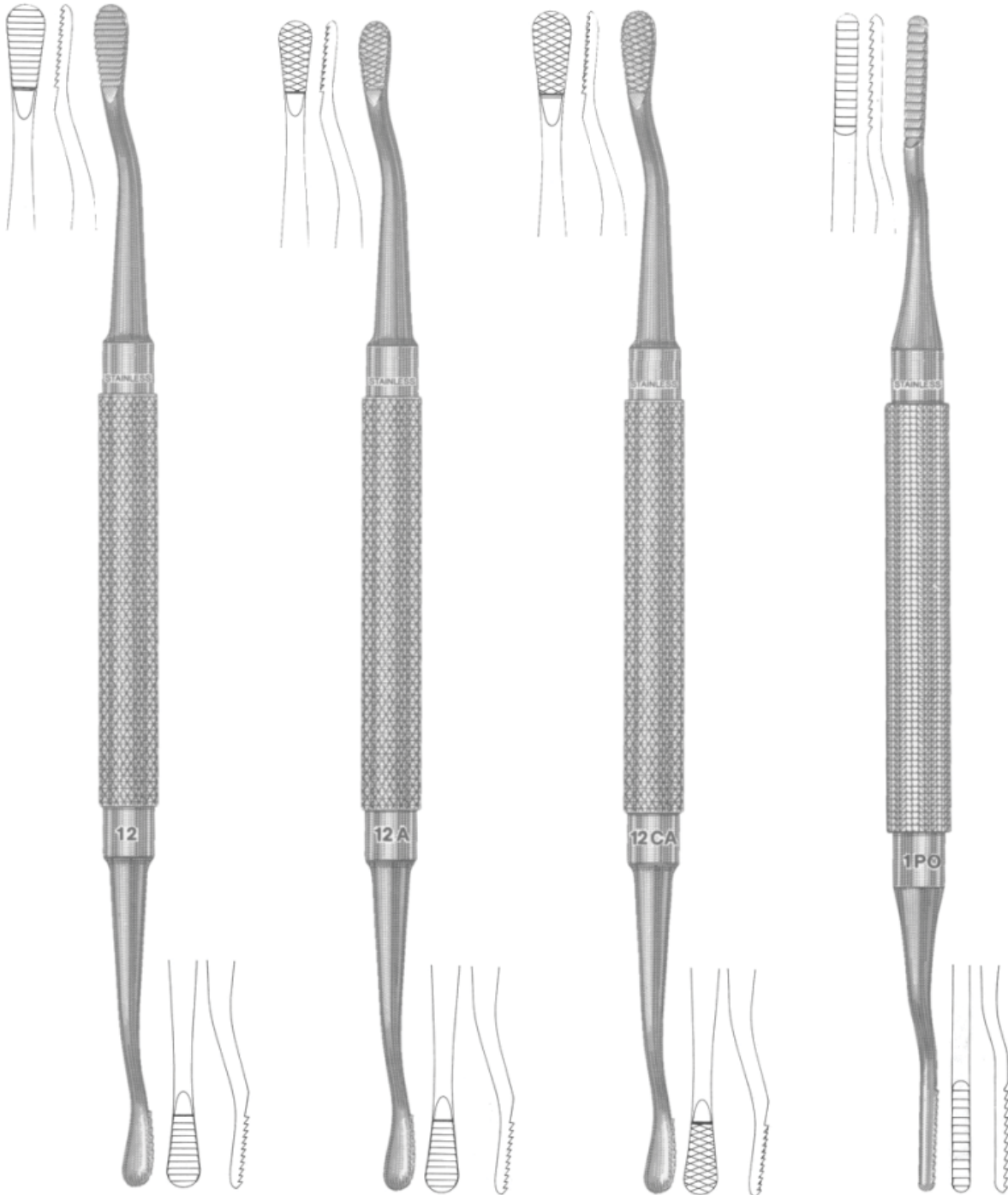

**2224**  
HOWARD  
No. 12

**2225**  
HOWARD  
No. 12A

**2226**  
HOWARD  
No. 12CA

**2227**  
POLOKOFF  
No. 1

GARDNER

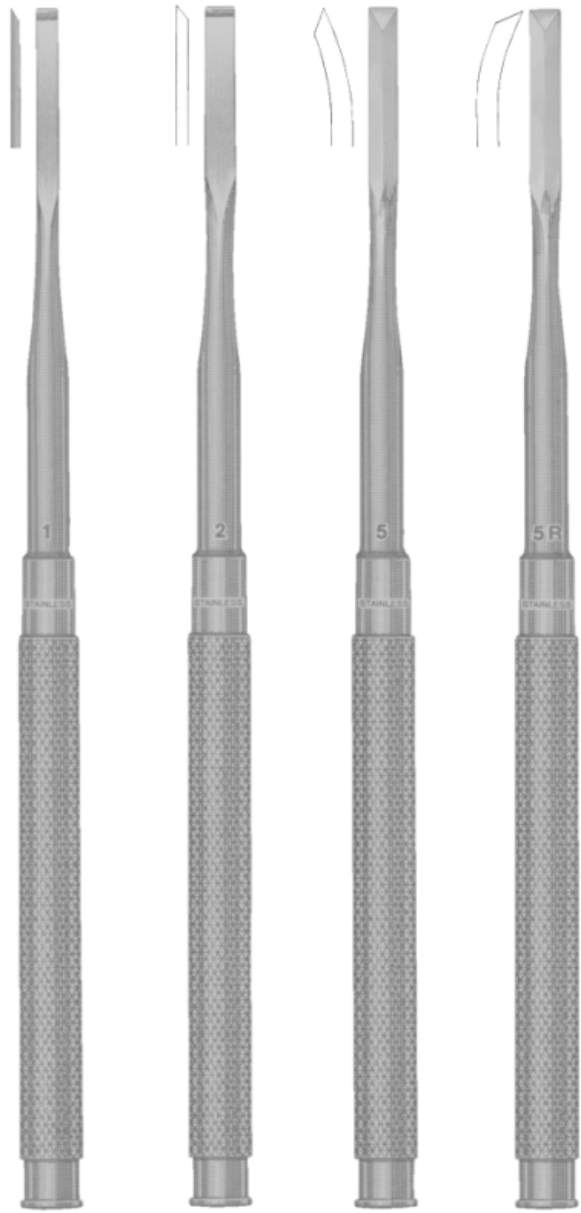

**2228**  
GARDNER  
No. 1

**2229**  
GARDNER  
No. 2

**2230**  
GARDNER  
No. 5

**2231**  
GARDNER  
No. 5R

WAKEFIELD

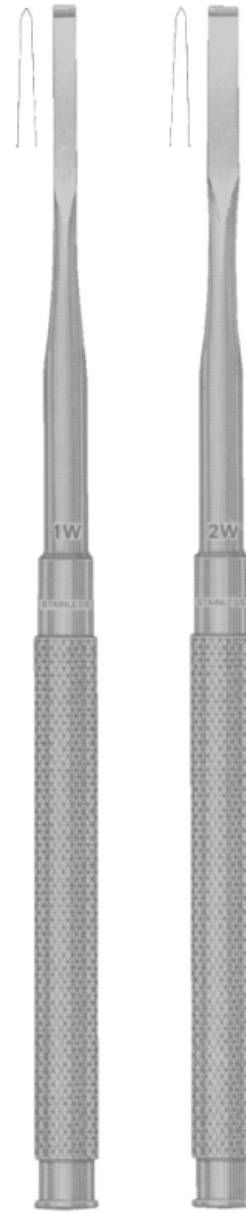

**2232**  
WAKEFIELD  
No. 1W

**2233**  
WAKEFIELD  
No. 2W

**Bone Chisels and Gouges**

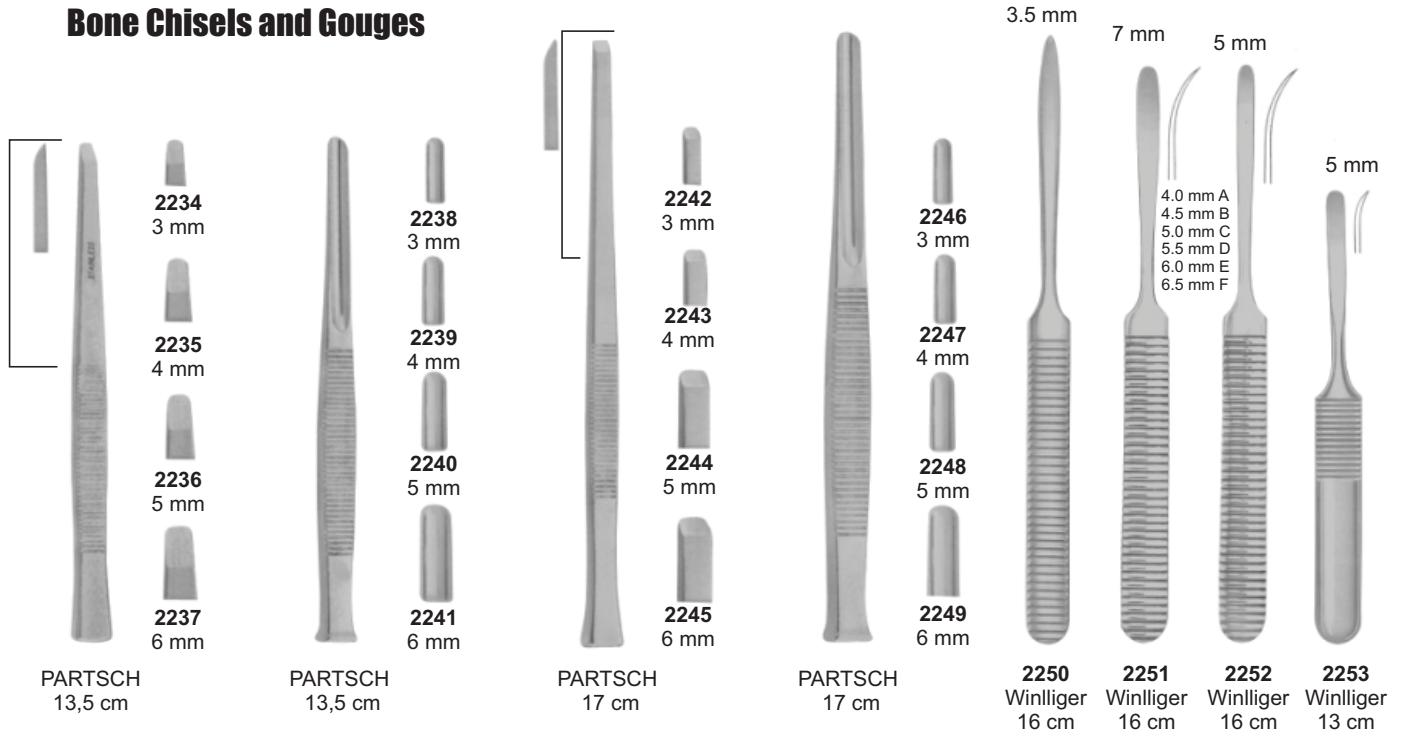

Martelli chirurgici  
Mallet

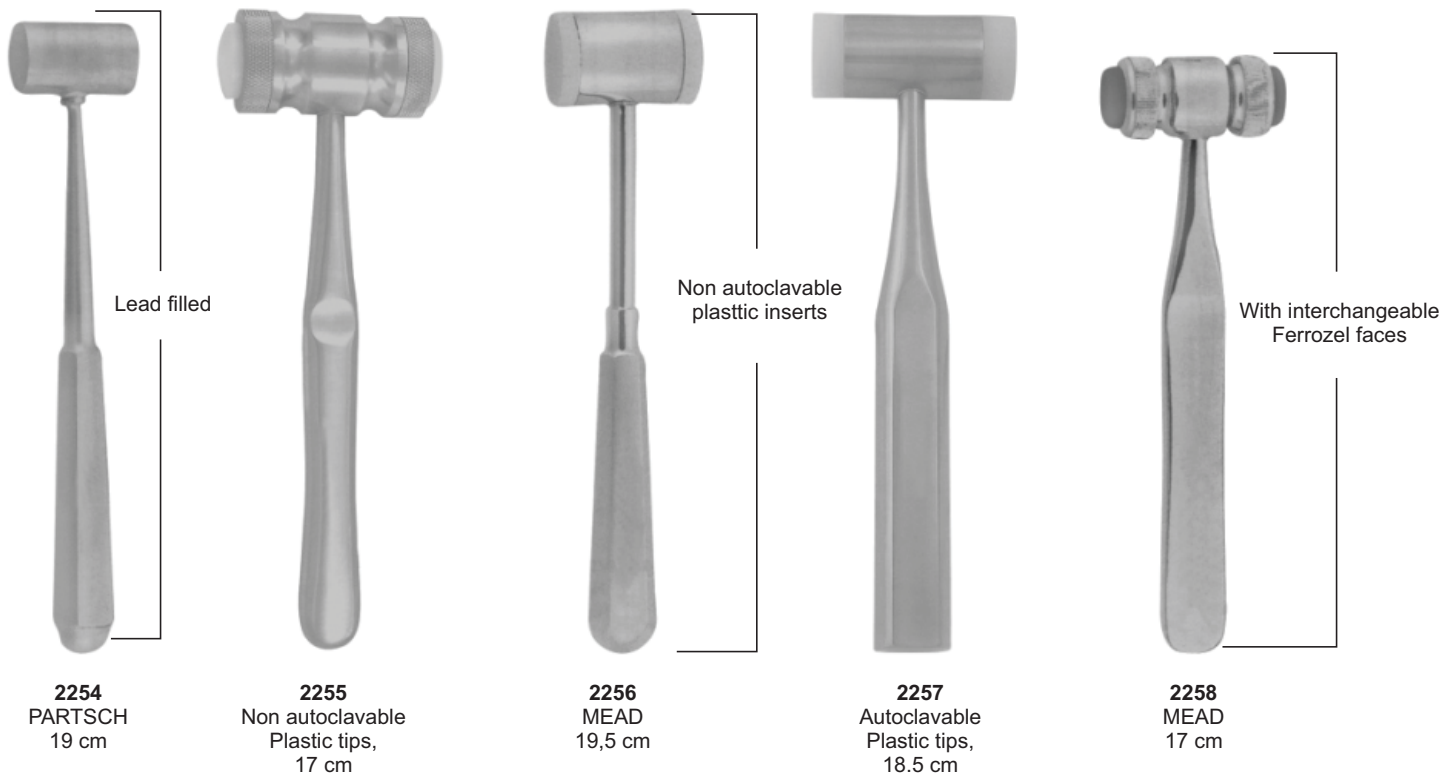



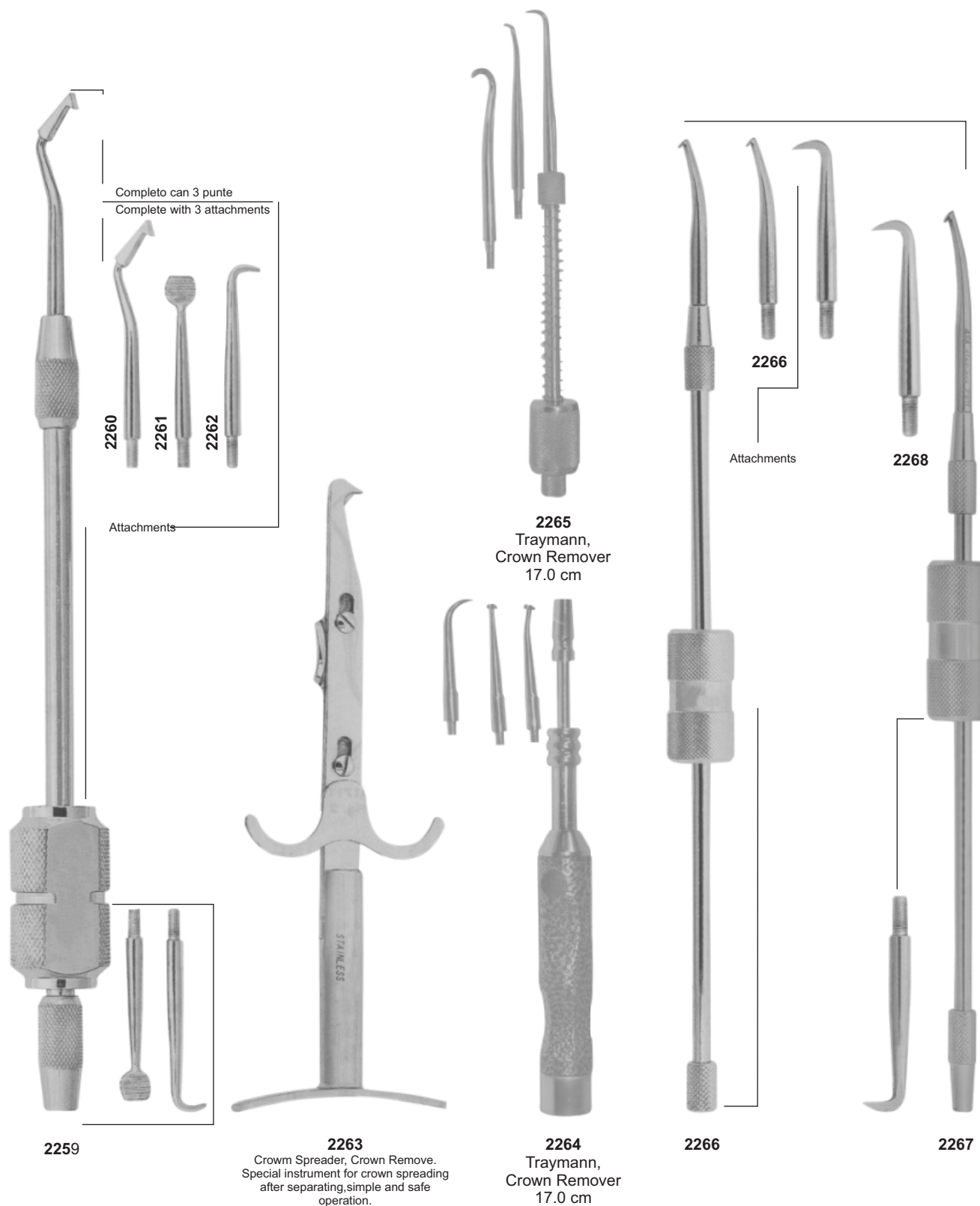

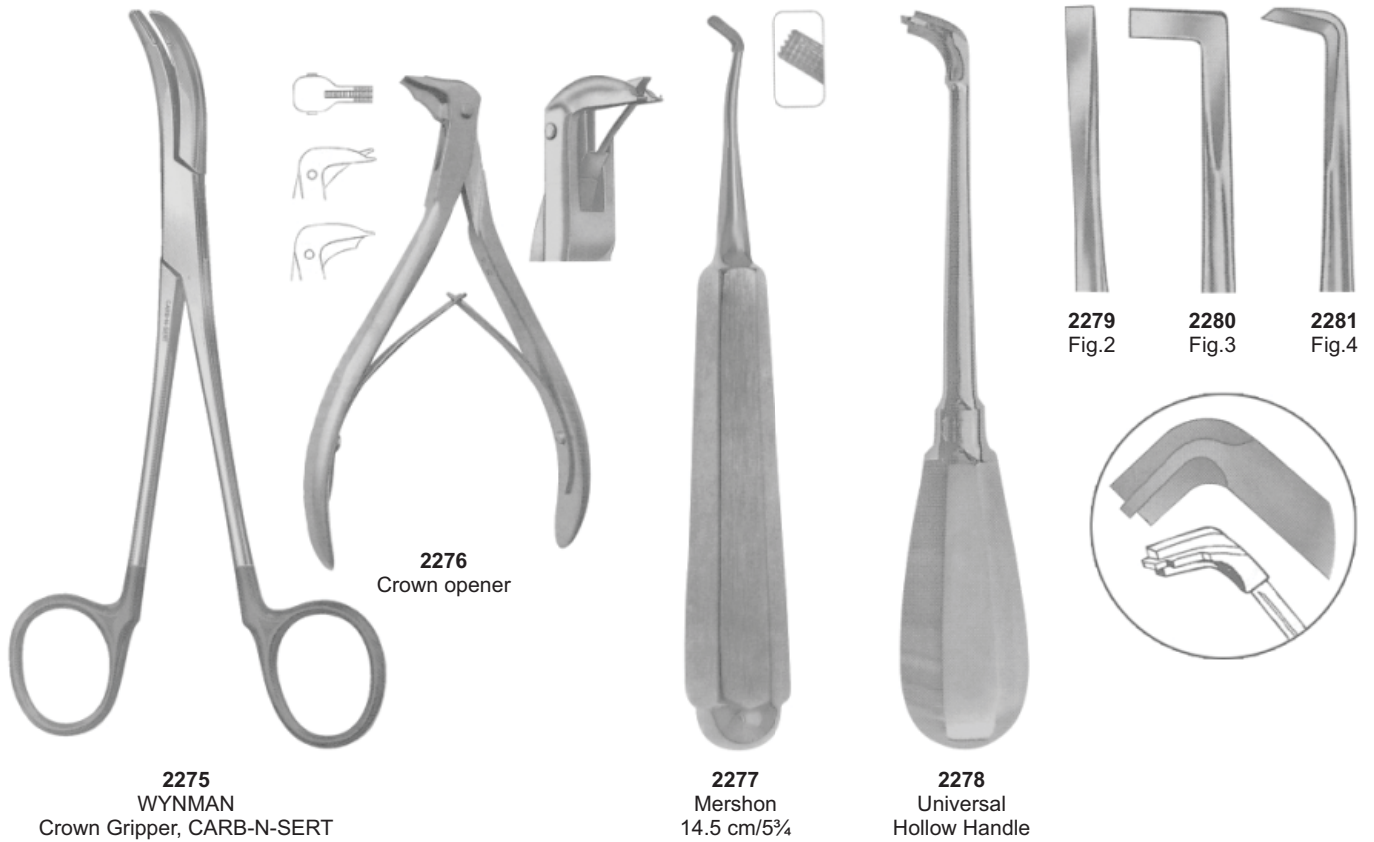
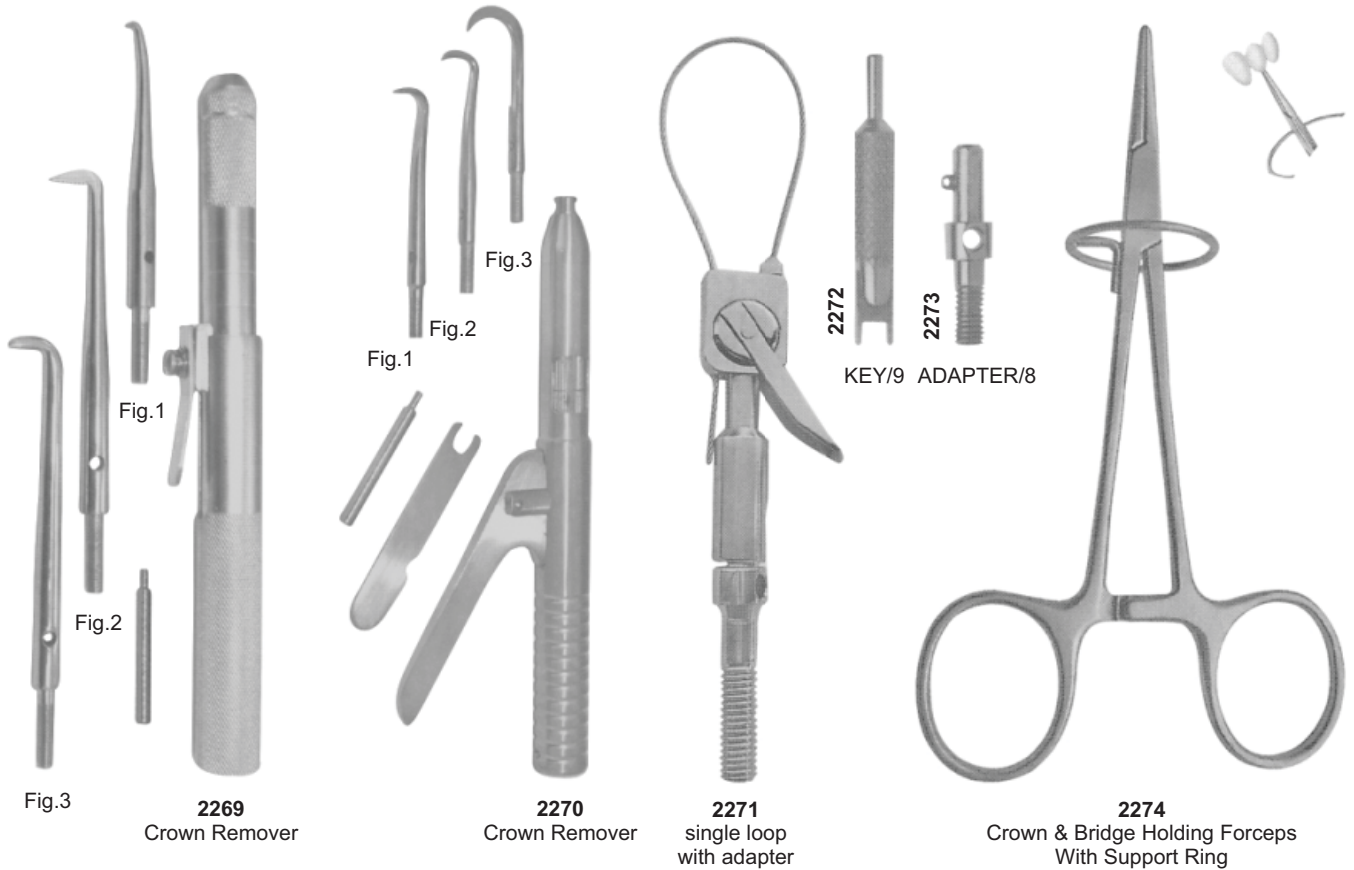



**2282**  
Plaster Shear  
210 mm



**2283**  
Crown Removing Plier  
14 cm



**2284**  
MONTFORT  
18 CM



**2285**  
BOHM  
16 cm



**2286**  
Telescope Crown  
Plier, Diamond coated  
13.0 cm



**2287**  
Telescope Crown  
Plier, Diamond coated  
13.0 cm



**2288**  
Telescope Crown Plier  
13.0 cm gerieften Maul  
15.0 cm gerieften Maul  
13.0 cm gelatts Maul  
15.0 cm gelatts Maul



**2289**  
Telescope Crown  
Plier, Fine  
15.0 cm



**2290**  
1P  
150 mm



**2291**  
Fig. 1  
155 mm

Ø 2 mm



1P  
150 mm

Ø 3 mm



1T  
150 mm

Ø 1.60 mm



1  
155 mm



4  
155 mm

Ø 2.7 mm

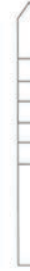

2P  
150 mm

Ø 4 mm



2T  
150 mm

Ø 1.90 mm



2  
155 mm



5  
155 mm

Ø 3.25 mm



3P  
150 mm

Ø 5 mm



3T  
150 mm

Ø 2.80 mm



3  
155 mm



6  
155 mm

Ø 3.8 mm

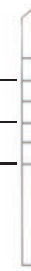

4P  
150 mm

8 mm  
10 mm  
12 mm  
14 mm  
16 mm  
18 mm

5 mm  
10 mm  
15 mm  
20 mm



**2292**  
Fig. 1B  
165 mm

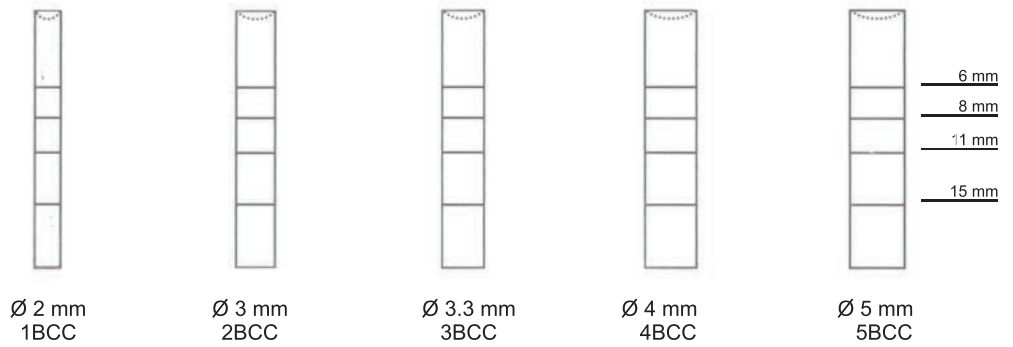
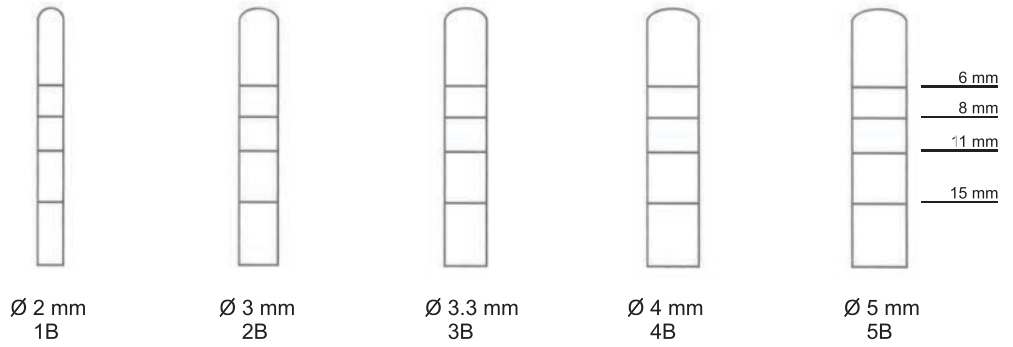

**2293**  
Fig. 1  
155 mm

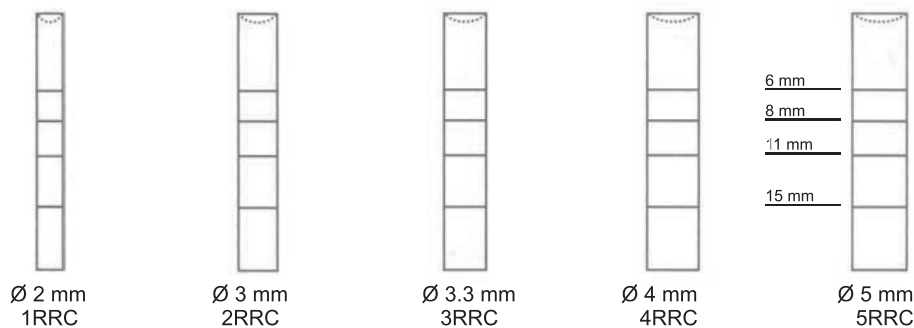
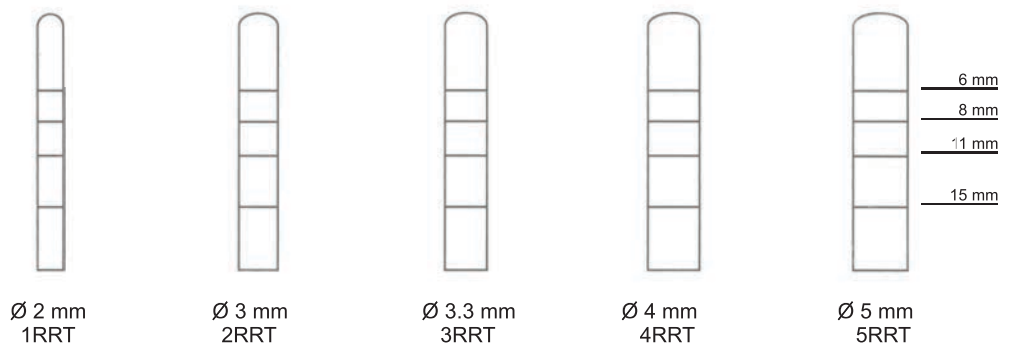

## Endo guns for retrograds.

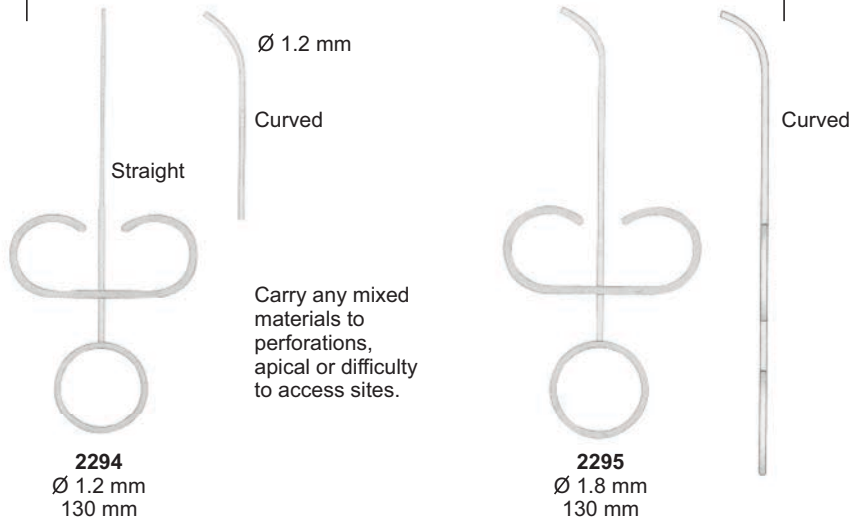

## Bone Injectors



Bone well

**2301**  
Ø 35 mm  
h 35 mm



**2302**  
Grinders for autogenous

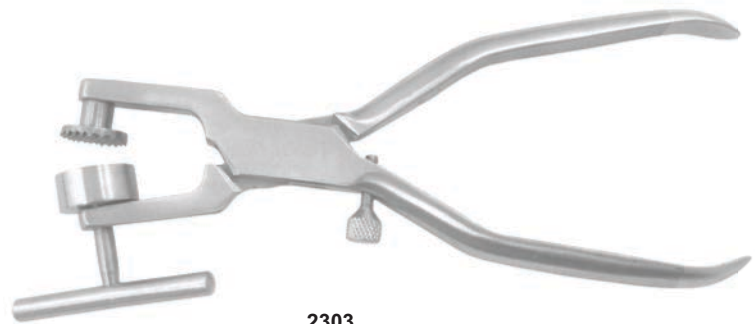

**2303**  
Bone Mill Forcep  
17.0 cm

**Suction Tubes**



**Bone Pluggers**



**Kerrison Rongeurs**



( 1.5 mm inside ) 2311  
 ( 2.0 mm inside ) 2312  
 ( 3.0 mm inside ) 2313  
 ( 4.0 mm inside ) 2314  
 ( 4.5 mm inside ) 2315  
**16.5 cm**

( 1.0 mm inside ) 2316  
 ( 2.0 mm inside ) 2317  
 ( 2.50 mm inside ) 2318  
**16.5 cm**



**2319**  
Fig. 1  
170 mm

**2320**  
Fig. 2  
175 mm

**2321**  
Fig. 3  
170 mm

**2322**  
LUCAS  
Fig. 88  
170 mm

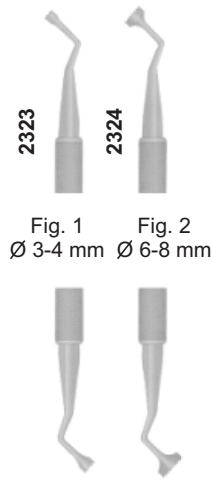
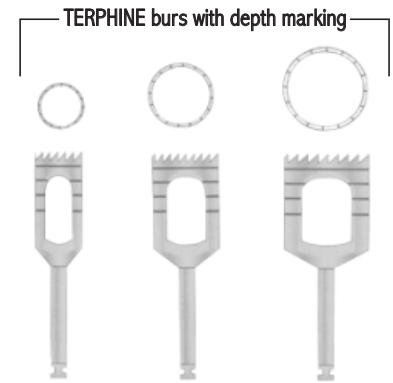

Fig. 1  
Ø 3-4 mm

Fig. 2  
Ø 6-8 mm

Bone Compactors.



**2325** Ext. Ø 3.5 mm Int. Ø 3 mm  
**2326** Ext. Ø 6 mm Int. Ø 5 mm  
**2327** Ext. Ø 8.5 mm Int. Ø 7.55 mm  
**2328** Ext. Ø 11 mm Int. Ø 10 mm

## Sinus lift instruments

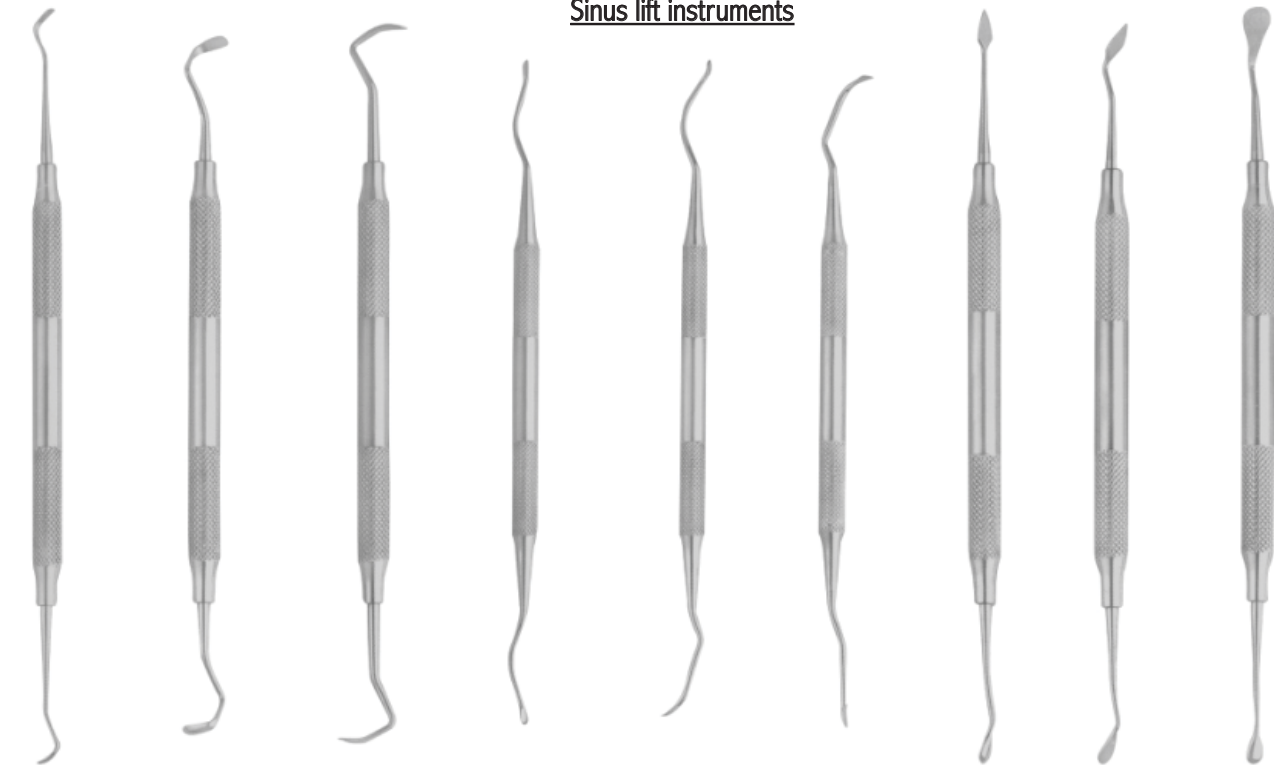

**2329**  
Fig.1

**2330**  
Fig.2

**2331**  
Fig.3

**2332**  
Fig.4

**2333**  
Fig.5

**2334**  
Fig.6

**2335**  
Fig.7

**2336**  
Fig.8

**2337**  
Fig.9



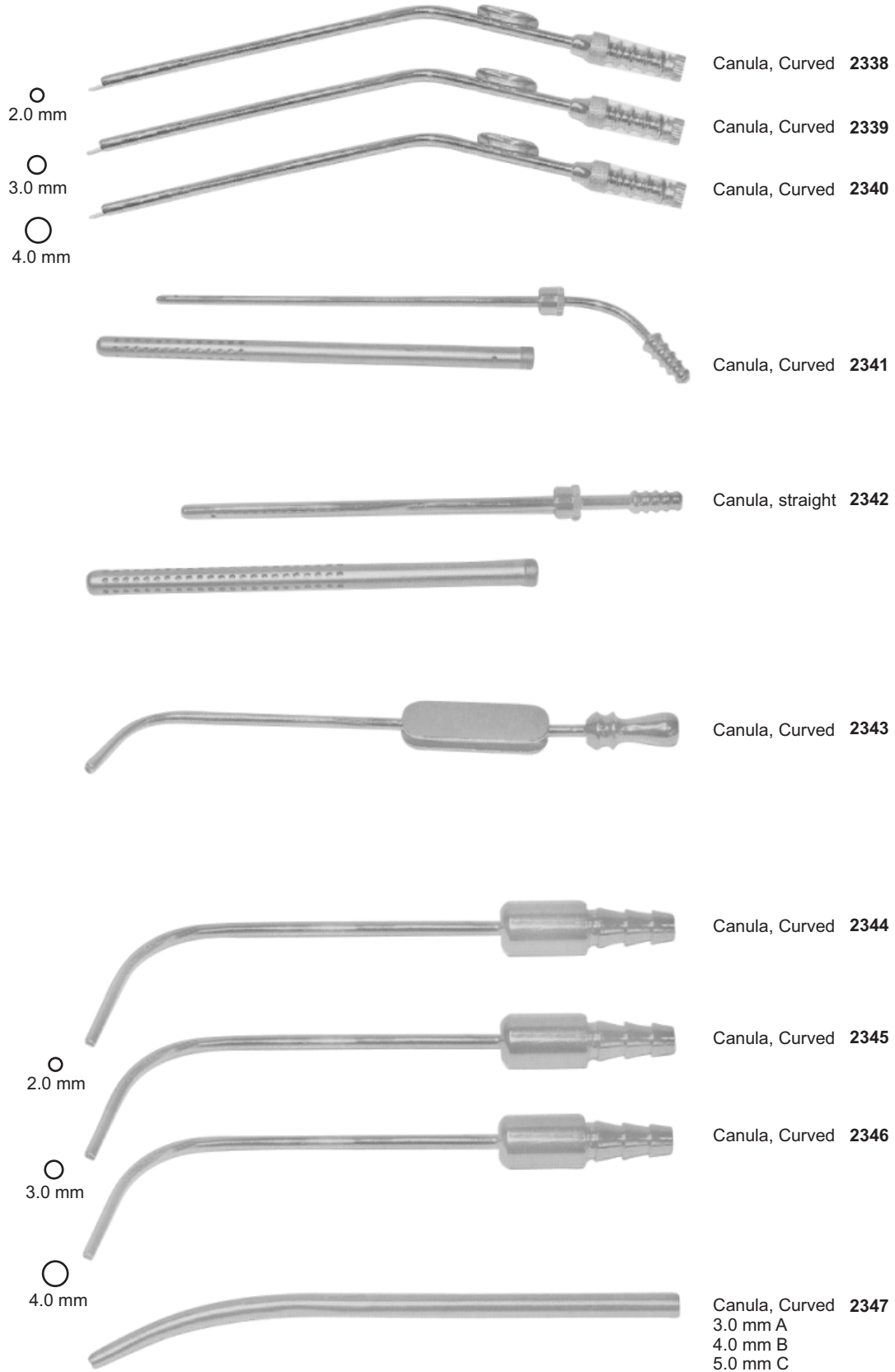

- ⟨☞⟩ Measuring Instruments
- ⟨☞⟩ Amalgam Guns & Carriers
- ⟨☞⟩ Retainers
- ⟨☞⟩ Rubber Dam Instruments
- ⟨☞⟩ Syringes
- ⟨☞⟩ Tweezers
- ⟨☞⟩ Sterilizing & Lab. Instruments



# 05

SECTION





**2348**  
BOLEY Gauge



**2349**  
ZURICHER  
130 mm



**2350**  
VERNIER  
12 cm



**2351**  
VERNIER



**2352**  
VERNIER Gauge



**2353**  
VERNIER Gauge



**2355**  
Finger Ruler

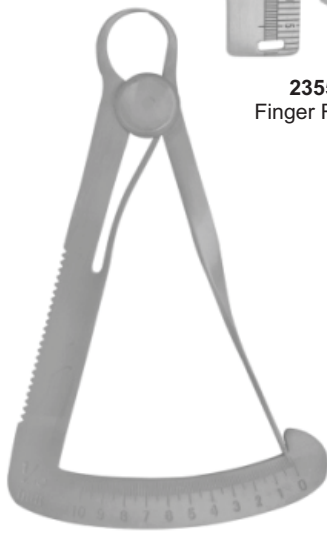

**2354**  
LWANSON  
Crown Gauge



**2356**  
LWANSON  
Crown Gauge



**2357**  
Sliding Gauge  
10 cm



**2358**  
Spring Bow Divider  
6" Radius



**2359**  
VERNIER  
Gauge



**2360**  
ALBEE



**2361**  
Height Gauge  
Wick Type

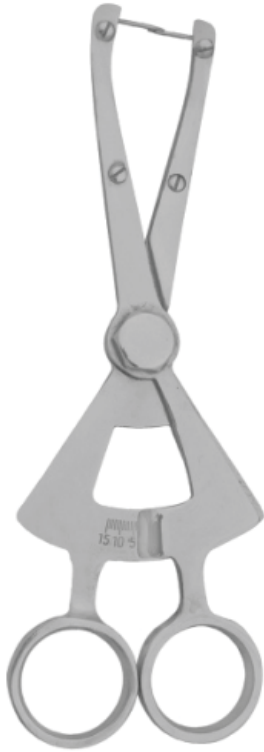

**2362**  
Bone Gauge



**2363**  
Bone Caliper  
15 cm



**2364**  
Castroviejo



**2365 A**  
Castroviejo  
Curved



**2365 B**  
Straight



**2366 C**  
Castroviejo  
Straight



**2366 D**  
Curved



**2367**  
Gauge

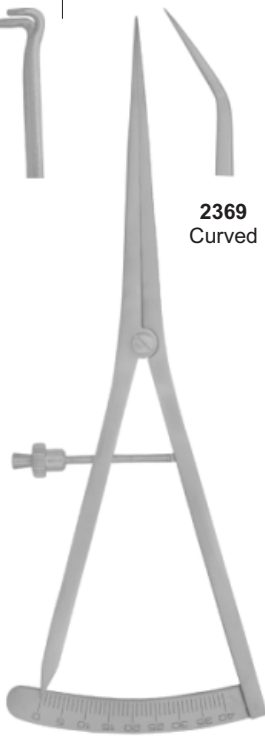

**2368**  
Castroviejo  
Straight



**2369**  
Curved

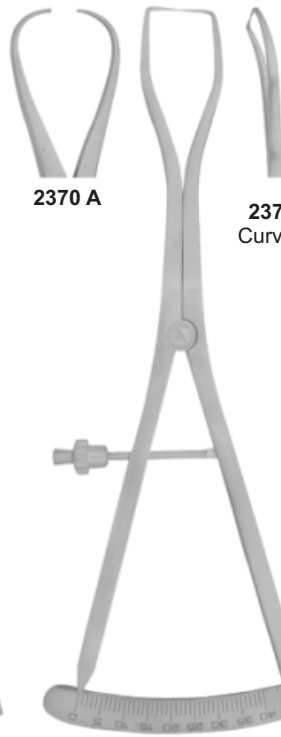

**2370**  
Castroviejo  
Straight



**2371**  
Curved



**2373**  
Boone - Gauge

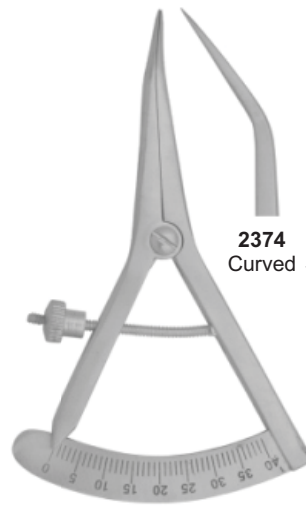

**2372**  
Castroviejo



**2374**  
Curved



**2375**  
Straight



**2376**  
Bracket Gauge. Ant/Post



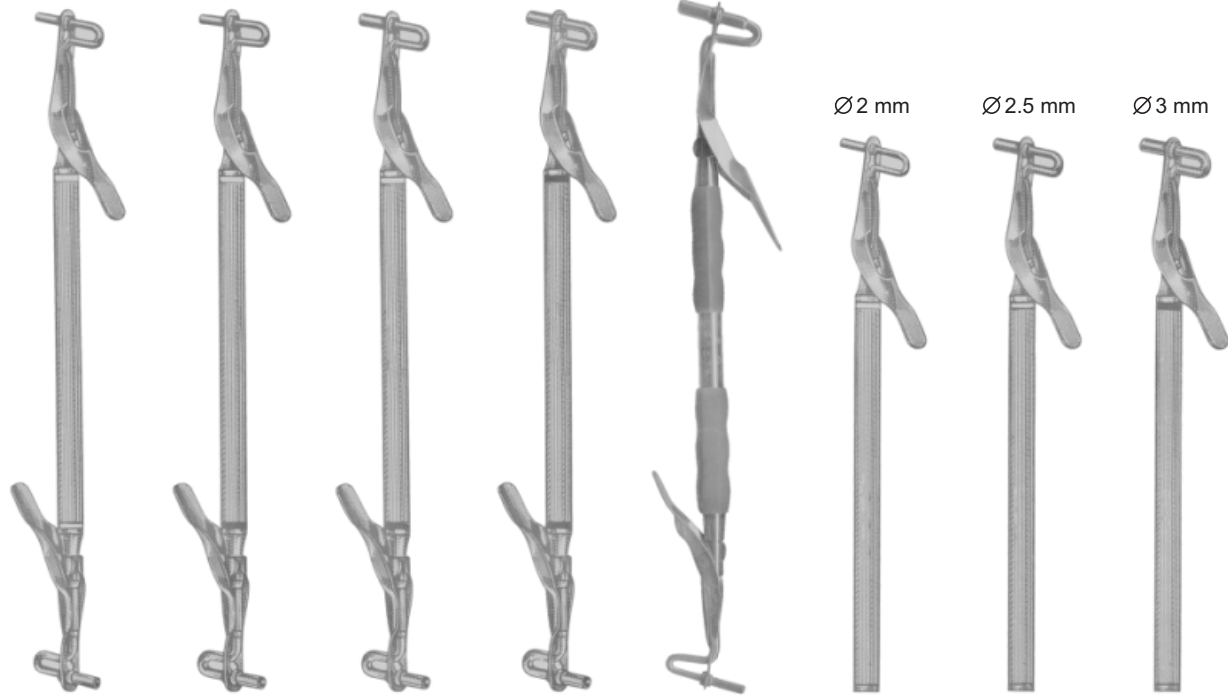

<b>2377</b> Medium-Large 20 cm	<b>2378</b> Medium-Jumbo 20 cm	<b>2379</b> Large-Jumbo 20 cm	<b>2380</b> Jumbo-Jumbo 20 cm	<b>2381</b> Regular-Jumbo Silicon Grip 20 cm	<b>2382</b> Medium 15.5 cm	<b>2383</b> Large 15.5 cm	<b>2384</b> Jumbo 15.5 cm
--------------------------------------	--------------------------------------	-------------------------------------	-------------------------------------	---	----------------------------------	---------------------------------	---------------------------------

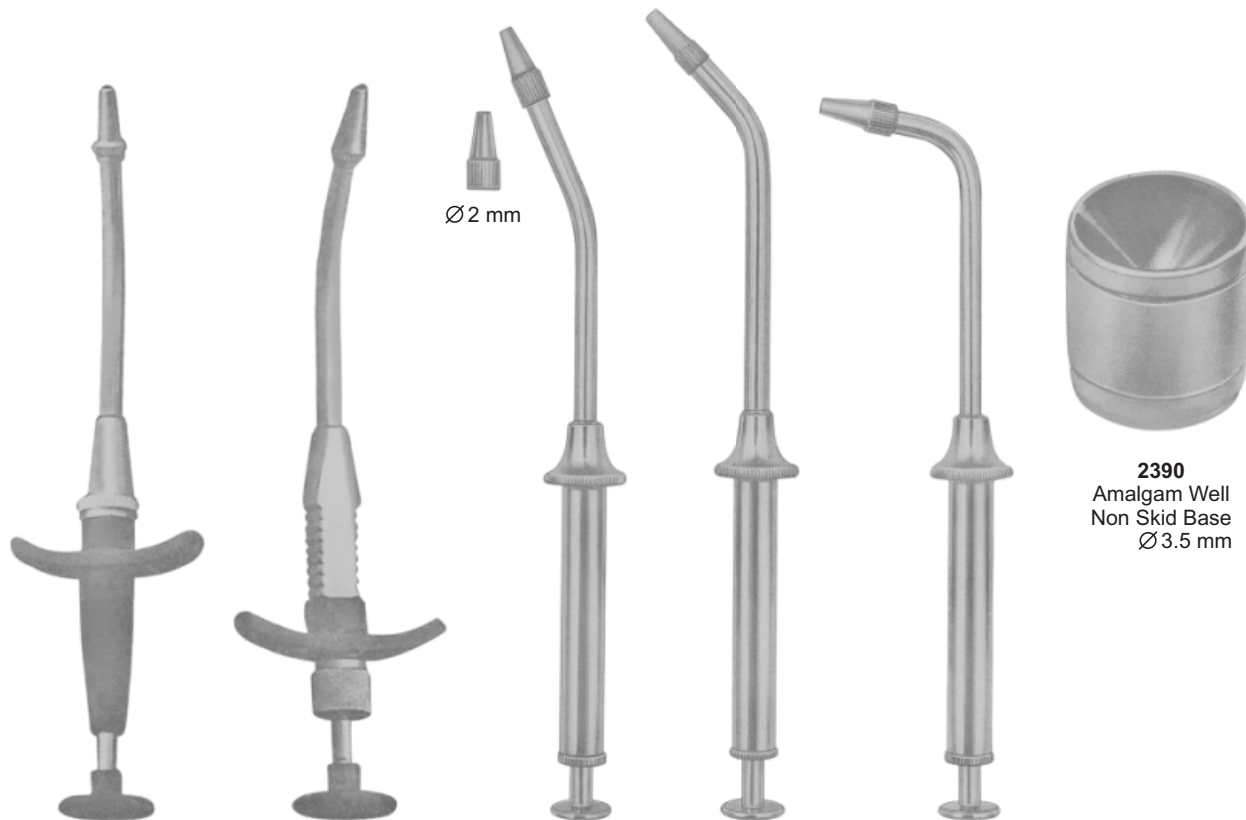

<b>2385</b> 145 mm	<b>2386</b> 130 mm	$\varnothing$ 2 mm <b>2387</b> Straight 15 cm	$\varnothing$ mm <b>2388</b> 15 cm	<b>2389</b> 15 cm 90°	<b>2390</b> Amalgam Well Non Skid Base $\varnothing$ 3.5 mm
-----------------------	-----------------------	--	--	-----------------------------	--

Retainers



**2391**  
No. 1

**2392**  
No. 8

**2393**  
No. 9

"Tofflemire" Type Retainers

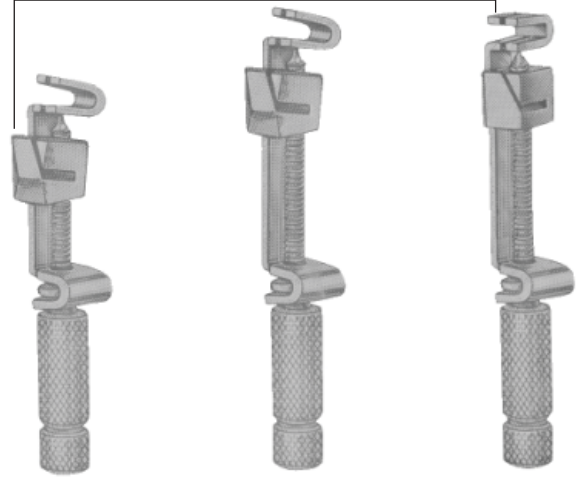

**2394**  
JUNIOR-CA

**2395**  
SENIOR-CA

**2396**  
UNIVERSAL

Tofflemire Bands

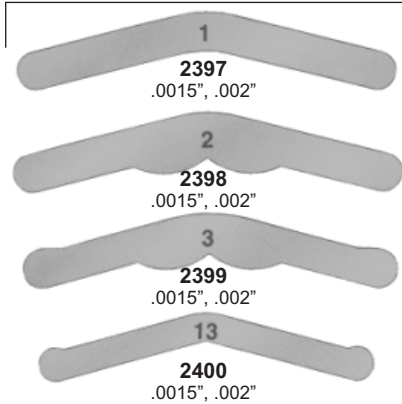

**1**  
**2397**  
.0015", .002"

**2**  
**2398**  
.0015", .002"

**3**  
**2399**  
.0015", .002"

**13**  
**2400**  
.0015", .002"

**2401**  
X-Ray Holder  
Small



**Set of 10**  
**2402**  
Film Hanger

Napkin Holders

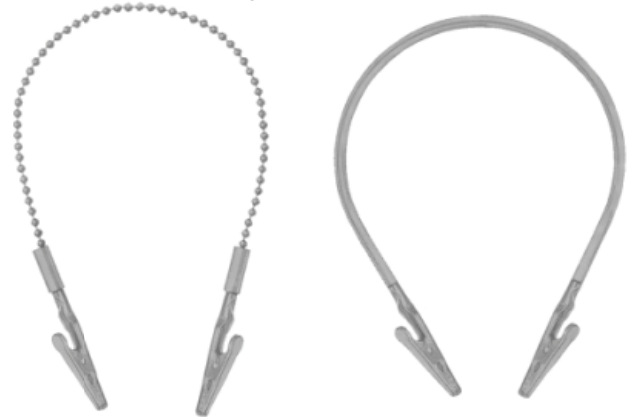

**2403**  
BALL CHAIN

**2404**  
NON-CHILL  
Clear Plastic

Strip Holders

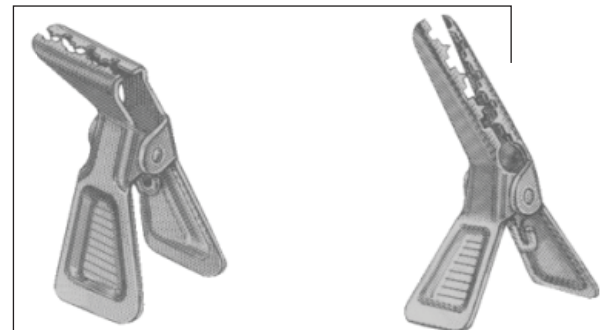

**2408**  
Strip Holder Clip  
90°

**2409**  
Strip Holder Clip  
45°

**2405**  
Finger Protector  
Small

**2406**  
Medium

**2407**  
Large



**2410**  
IRORY  
Light weight, 170 mm



**2411**  
BREWER  
175 mm

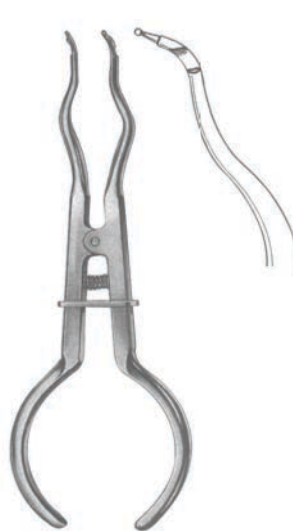

**2412**  
BREWER  
175 mm



**2413**  
WHITE  
175 mm



**2414**  
IVORY  
170 mm



**2415**  
AINSWORTH  
Rubber Dam Punch  
170 mm



**2416**  
AINSWORTH  
Rubber Dam Punch  
170 mm



**2417**  
AINSWORTH  
Rubber Dam Punch  
170 mm



**2418**  
"IV" Type  
Rubber Dam Punch  
160 mm



**2419**  
Plastic Rubber Dam  
Frame 242

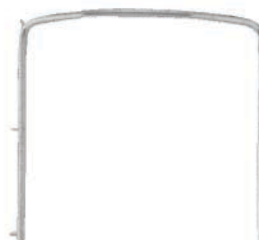

**2420**  
Rubber Dam Holder  
Stainless Steel Pins

## Articulating Paper Forceps



**2421**  
MILLER  
Articulating  
Forceps  
15 cm

**2422**  
MILLER  
Articulating  
Forceps  
15 cm

## LOWER MOLARS



**2423**  
76D-W3

**2424**  
76D-3



**2429**  
76D-7A

**2430**  
76D-7

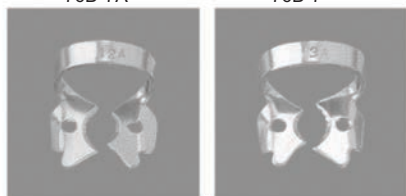

**2435**  
76D-12A

**2436**  
76D-13A

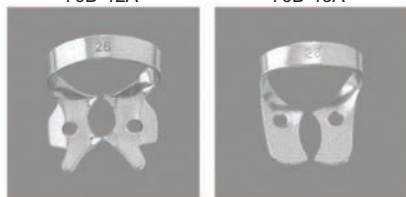

**2441**  
76D-26

**2442**  
76D-28



**2445**  
76D-W8A

**2446**  
76D-8A

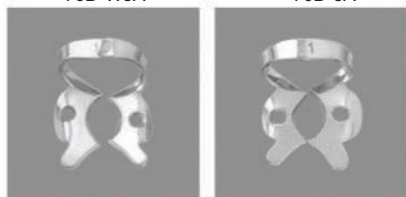

**2447**  
76D-10

**2448**  
76D-11



**2451**  
76D-24

**2452**  
76D-25

## UPPER MOLARS

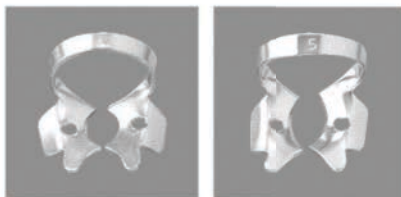

**2425**  
76D-4

**2426**  
76D-5



**2431**  
76D-8

**2432**  
76D-26N

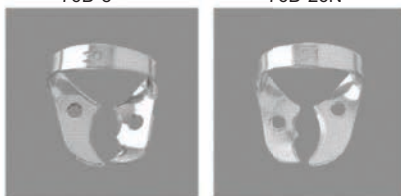

**2437**  
76D-30

**2438**  
76D-31



**2443**  
76D-201

**2444**  
205

## PREMOLARS



**2427**  
76D-0

**2428**  
76D-1

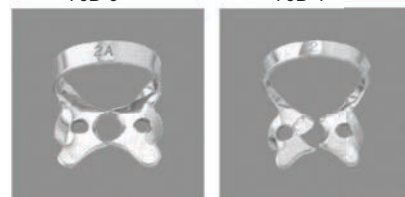

**2433**  
76D-2A

**2434**  
76D-2

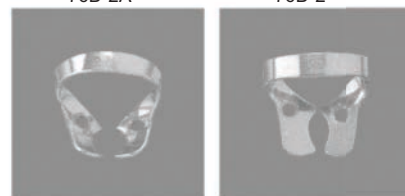

**2439**  
76D-27N

**2440**  
76D-29

## ANTERIOR

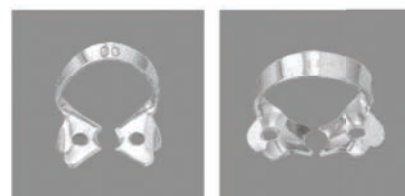

**2456**  
76D-00

**2457**  
76D-1A



**2458**  
76D-9

**2459**  
76D-212

## MOLARS



**2449**  
76D-14

**2450**  
76D-118



**2453**  
76D-27

**2454**  
76D-56



**2455**  
76D-14A



4969/CO



4969/F



4969/CV



**2460**  
ml 1,8  
EU

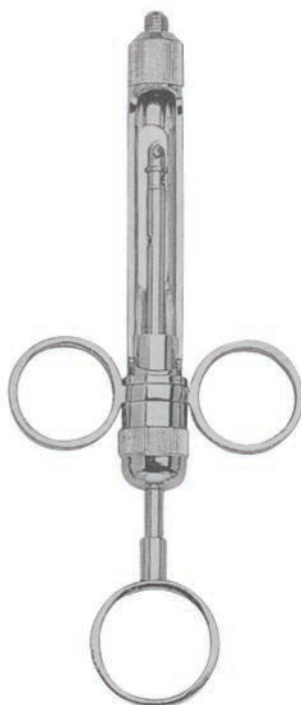

**2461**  
ml 1,8  
EU/AM

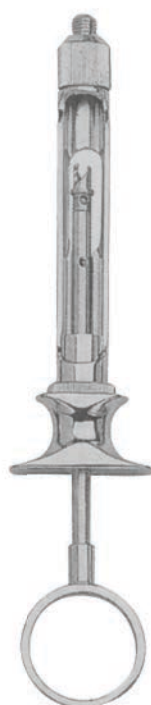

**2462**  
ml 1,8  
EU/AM



**2463**  
Fig. 1  
ml 1,8  
EU



**2464**  
Fig. 1  
ml 1,8  
EU



**2465**  
SS INOX  
All inox & autoclavable  
black plastic handle  
passive automatic  
aspiration.



**2466**  
Fig. 1  
ml 1,8  
EU/Am



**2467**  
Fig. 1  
ml 1,8  
EU/Am



**2468**  
Fig. 1  
ml 1,8  
EU/Am

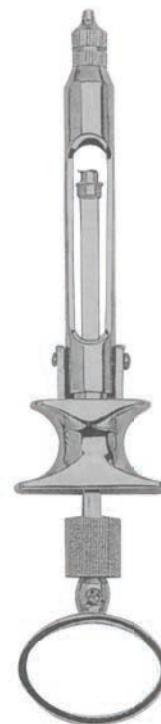

**2469**  
ml 1,2  
EU/Am

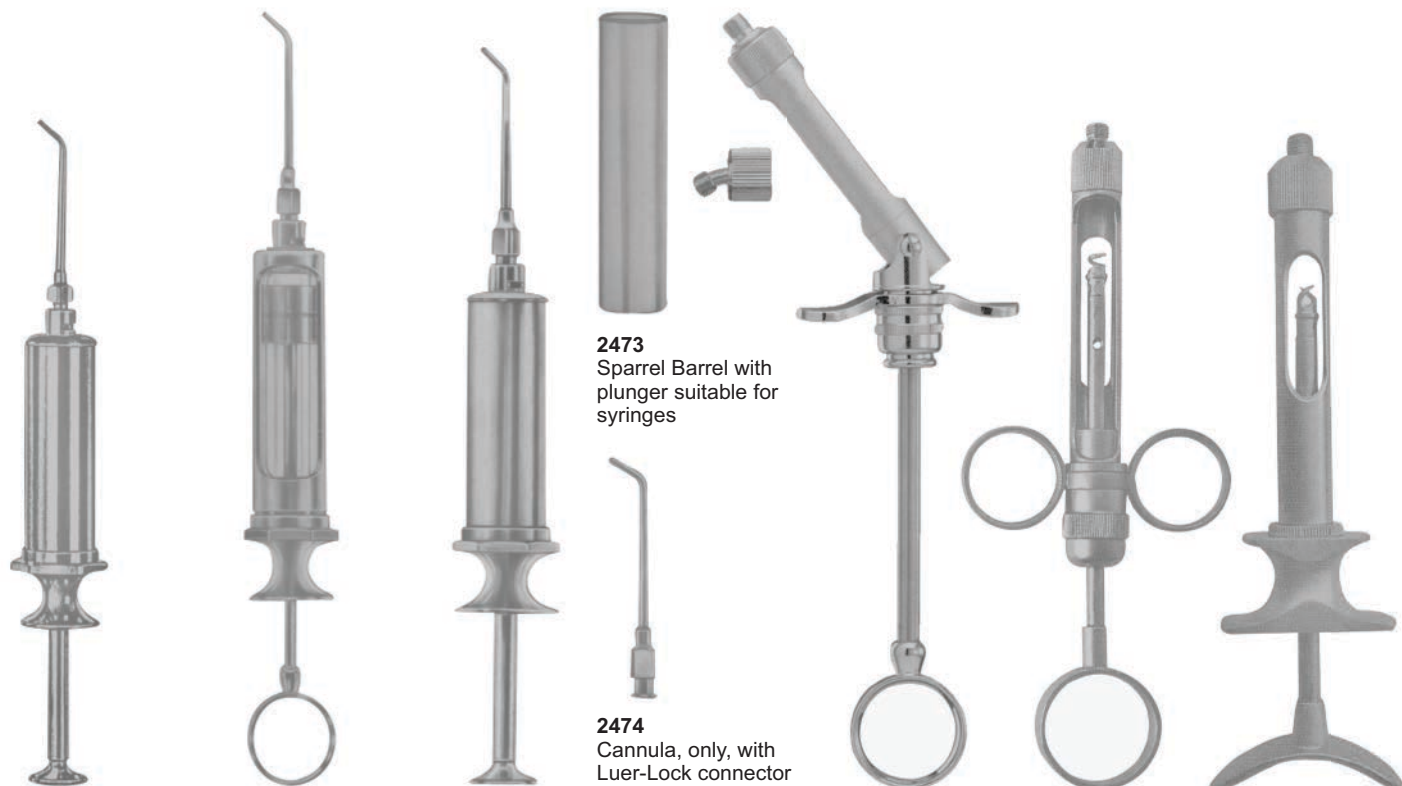

**2470**  
Water Syringe  
complete with  
1 cannula (Lure-Lock)

**2471**  
Water Syringe  
complete with  
1 cannula (Lure-Lock)

**2472**  
Metal Water Syringe  
self-filling, with 1  
cannula (Lure-Lock)

**2473**  
Sparrel Barrel with  
plunger suitable for  
syringes

**2474**  
Cannula, only, with  
Luer-Lock connector  
suitable for syringes

**2475**  
Articulating  
Barrel Syringe

**2476**  
ml 1,8

**2477**  
ml 1,8



**2478**

**2479**

**2480**

**2481**  
Fig. 1  
ml 1,8 EU

**2485**  
Fig. 1  
ml 1,8 EU

**2482**  
Water  
point

**2483**  
Water  
point

**2484**  
Water  
point



**2486**  
ADSON  
Curved 14 cm

**2487**  
ADSON  
1X2 / 12 cm

**2488**  
ADSON  
12 cm

**2489**  
MICRO ADSON  
15 cm

**2490**  
STANDARD  
14,18,25 cm

**2491**  
CUSHING  
18 cm

**2492**  
Curved

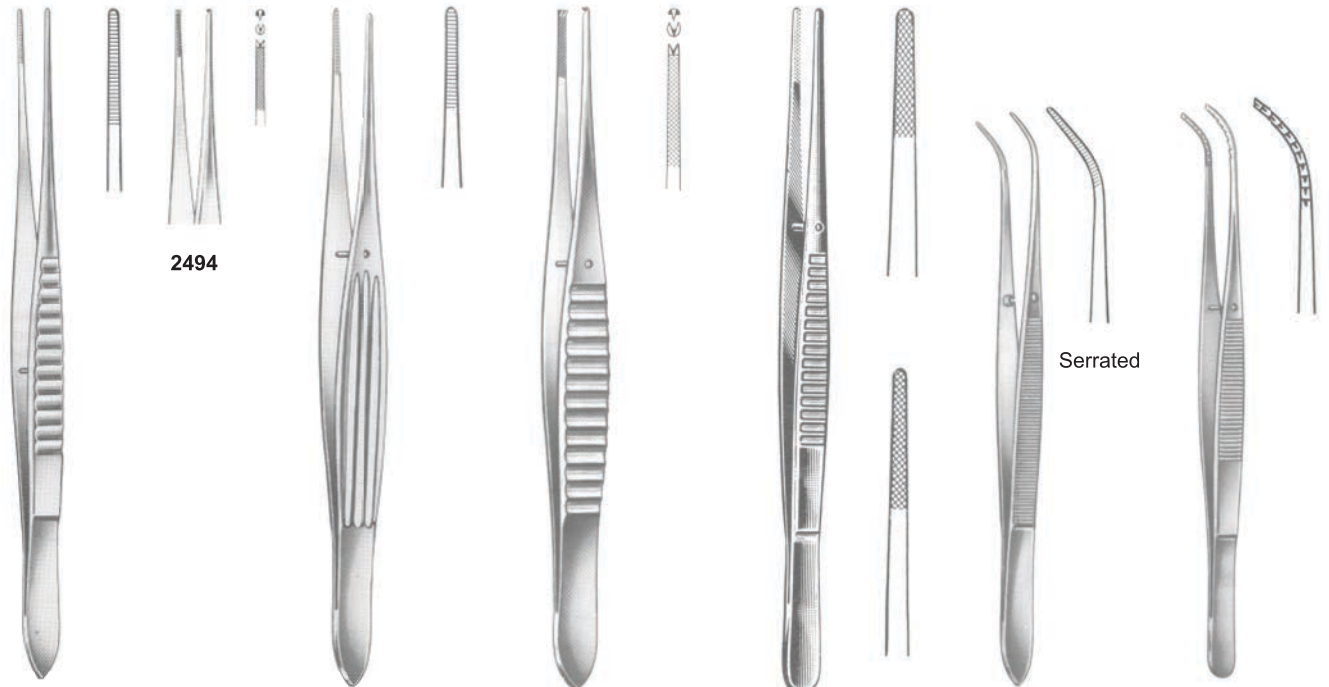

**2493**  
SELECT  
15,18,20 cm

**2494**

**2495**  
MCINDOE  
15 cm

**2496**  
GILLIES  
15 cm

**2497**  
WAUGH  
15,20 cm

Serrated

**2498**  
PERRY  
13 cm

**2499**  
KOPP  
15.5 cm



smooth

**2500**  
COLLEGE  
15 cm



serrated

**2501**  
COLLEGE  
15 cm



smooth

**2502**  
COLLEGE  
15 cm



serrated

**2503**  
COLLEGE  
15 cm



smooth

**2504**  
COLLEGE  
15 cm



serrated

**2505**  
COLLEGE  
15 cm



smooth

**2506**  
COLLEGE  
15 cm



serrated

**2507**  
COLLEGE  
15 cm



**2508**  
MERIAM  
16 cm



smooth



**2509**  
MERIAM  
16 cm



serrated



**2510**  
MERIAM  
16 cm



smooth



**2511**  
MERIAM  
16 cm



serrated



**2512**  
MERIAM  
16 cm



smooth



**2513**  
MERIAM  
16 cm



serrated



**2514**  
MERIAM  
16 cm



smooth



**2515**  
MERIAM  
16 cm



serrated

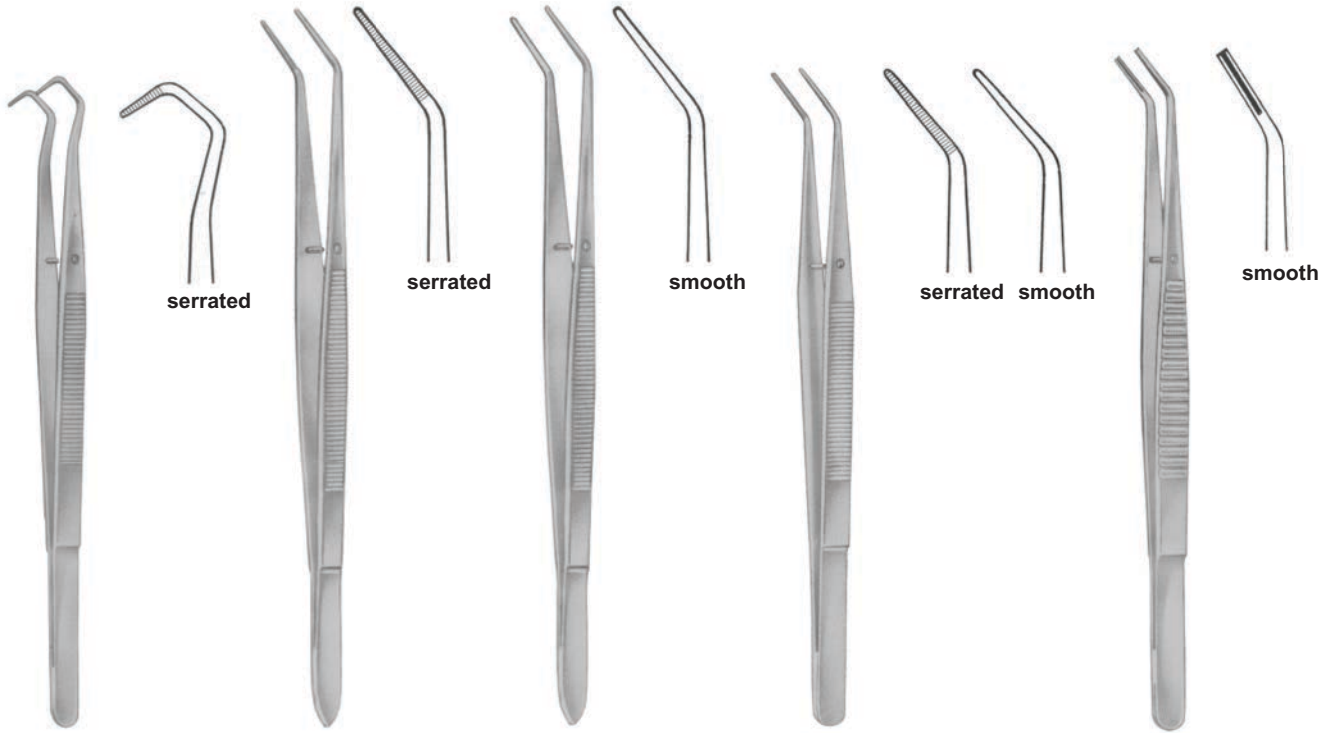

**2516**  
COLLEGE  
14.5 cm, 5<sup>3</sup>/<sub>4</sub>"

**2517**  
FLAGG  
16 cm, 6<sup>1</sup>/<sub>4</sub>"

**2518**  
FLAGG  
16 cm, 6<sup>1</sup>/<sub>4</sub>"

**2519**  
LANDGRAF  
15 cm, 6"

**2520**  
15,5 cm, 6<sup>1</sup>/<sub>8</sub>"

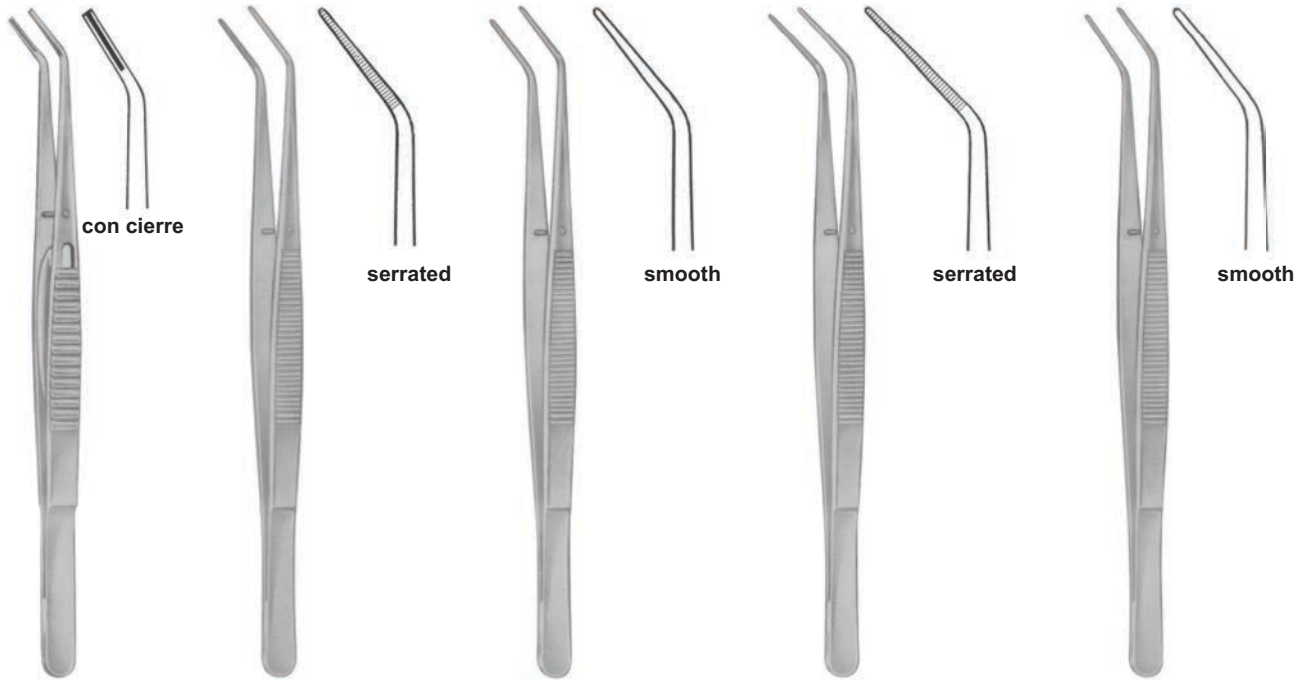

**2521**  
15.5 cm, 6<sup>1</sup>/<sub>8</sub>"

**2522**  
LONDON-COLLEGE  
15 cm, 6"

**2523**  
LONDON-COLLEGE  
15 cm, 6"

**2524**  
LONDON-COLLEGE  
15 cm, 6"

**2525**  
LONDON-COLLEGE  
15 cm, 6"



**2526**  
LONDON-COLLEGE  
15 cm, 6"



**2527**  
LONDON-COLLEGE  
15 cm, 6"



con cierre



**2528**  
MERIAM  
16 cm, 6 1/4"



serrated



smooth



**2529**  
ALLEN  
18 cm, 7 1/8"



**2530**  
ALBRECHT  
16 cm, 6 1/4"



**2531**  
ALBRECHT  
16 cm, 6 1/4"



**2532**  
16 cm, 6 1/4"



**2533**  
16 cm, 6 1/4"



**2534**  
16 cm, 6 1/4"





**2535**  
DAVIS  
6"



**2536**  
Grasping Forceps  
6 1/4"



**2537**  
Mesh Bur & Diamond Holder  
Large, 2 1/8" Diameter



**2538**  
Soldering Tweezers  
6 1/4"



**2539**  
Narrow Fine  
4 3/4"



**2540**  
Super Fine  
4 3/8"



**2541**  
Fine Curved  
4 1/2"



**2542**  
Bonding Bracket  
Holder  
136 mm



**2543**  
Bonding Bracket  
Holder  
135 mm



**2544**  
Bonding Bracket  
Holder  
135 mm



**2545**  
Bonding Bracket  
Holder  
140 mm







**The Avion**  
MFG. EXPORT. CO

- ⟨☞⟩ Endodontic Forceps
- ⟨☞⟩ Tissue Forceps
- ⟨☞⟩ Retractors
- ⟨☞⟩ Mouth Gags



# 06

SECTION





**2546**  
Endo Forceps  
4 3/4"



**2547**  
PEETS Forceps  
4 3/4", Useful For  
Removing Broken  
Instruments

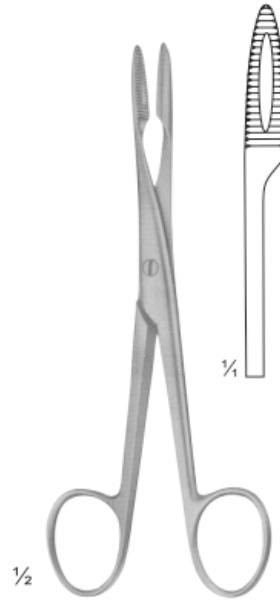

**2548**  
Without Ratchet  
145 mm

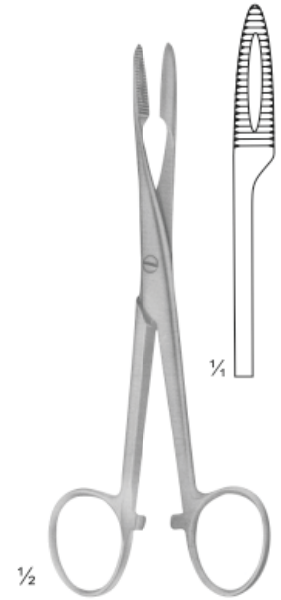

**2549**  
With Ratchet  
145 mm

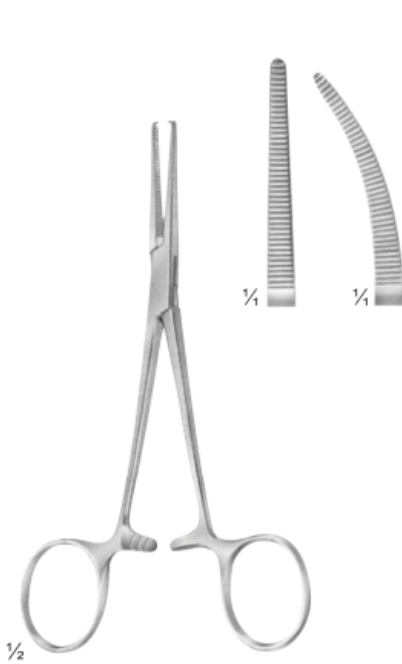

**2550**  
CRILE  
140 mm

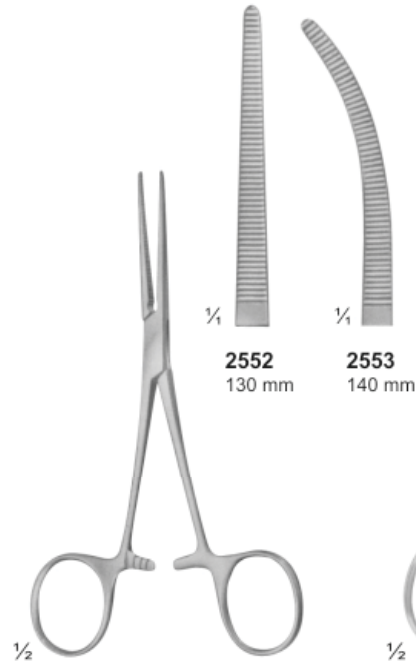

**2551**  
PEAN  
Slender type

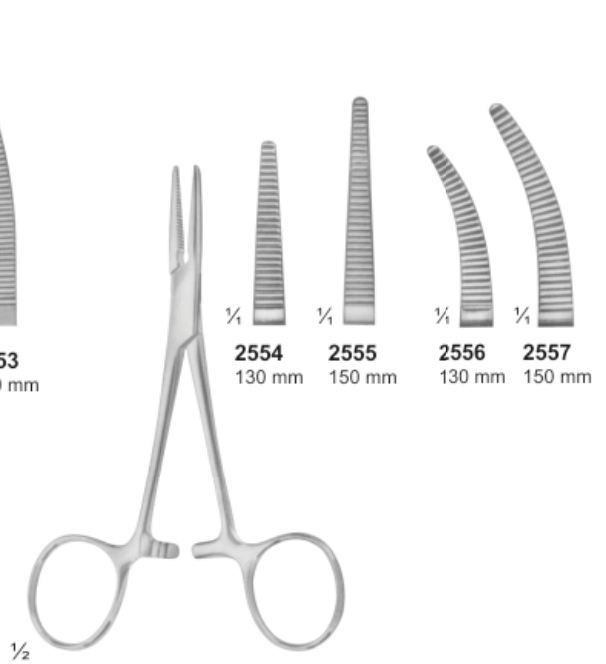

**2554**  
SPENCER-WELLS

**2552**  
130 mm

**2553**  
140 mm

**2554**  
130 mm

**2555**  
150 mm

**2556**  
130 mm

**2557**  
150 mm

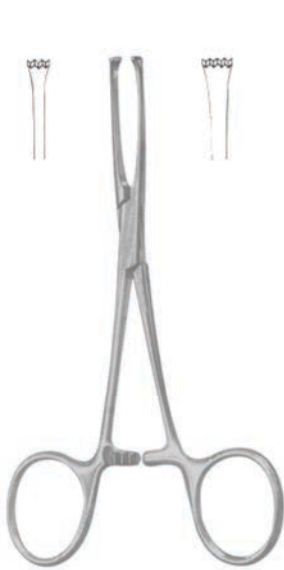

**2558**  
BABY-ALLIS  
5", Straight  
4x5 teeth extra delicate



**2559**  
ALLIS  
6", Straight  
4x5 teeth extra delicate



**2560**  
ALLIS  
6", Straight  
4x5 teeth extra delicate



**2561**  
1x2 teeth  
6"



**2562**  
SEMKIN  
6", Straight,  
1x2 teeth



**2563**  
ADSON  
4 3/4"  
1x2 teeth



**2564**  
BROWN-ADSON  
4 3/4"  
7x7 teeth



**2565**  
BROWN  
6"  
8x8 teeth



**2566**  
RUSSIAN  
6"  
8x8 teeth



**2567**  
Extra-Delicate,  
Straight, 4"  
1x2 teeth



**2568**  
HALSTED-MOSQUITO  
Straight, Curved, 5"



**2569**  
HALSTED-MOSQUITO  
Straight, Curved, 5"  
1x2 teeth



**2570**  
HALSTED-MOSQUITO  
Jaws 45 Angled on Flat, 5"  
Extra Delicate



**2571**  
KELLY  
5 1/2", Straight

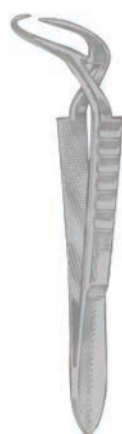

**2572**  
JONES  
3 1/2"



**2573**  
BACKHAUS  
3 1/2"



**2574**  
BACKHAUS  
5 1/4"



**2575**  
LORNA  
Non Perforated  
3 1/2"

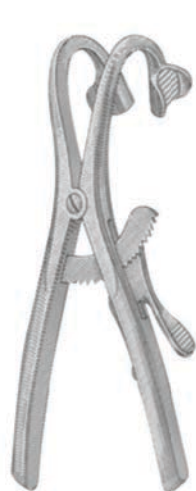

**2576**  
DENHART



$\frac{1}{2}$   
**2577**  
DENHART  
Mouth Gag With  
Silicon Inserts,  
Interchangeable  
Size: 125 mm

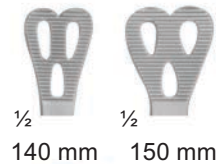

**2578**  
WIEDER  
Tongue depressor  
**2579** 140mm  
**2580** 150mm

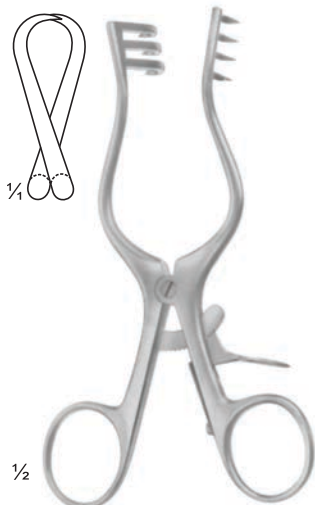

**2583**  
WEITLANER  
Sharp  
130 mm

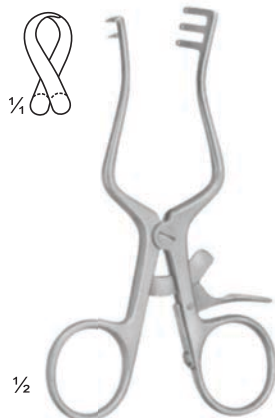

**2584**  
WEITLANER  
Sharp  
110 mm

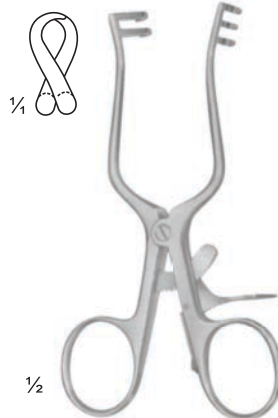

**2585**  
WEITLANER  
Semi-Sharp  
110 mm



**2581**  
TOBOLD  
Tongue depressor  
Size: 145 mm



**2582**  
ANDREW  
Tongue depressor  
Size: 110 mm



**2586**  
MOLT  
Pediatric



**2587**  
MOLT  
Child



**2588**  
MOLT  
Adult



**2589**  
FERGUSON-ACKLAND  
Mouth Gag  
Size: 145 mm



**2590**  
ROSER KOENIG  
Mouth Gag  
Size: 160mm / 185mm

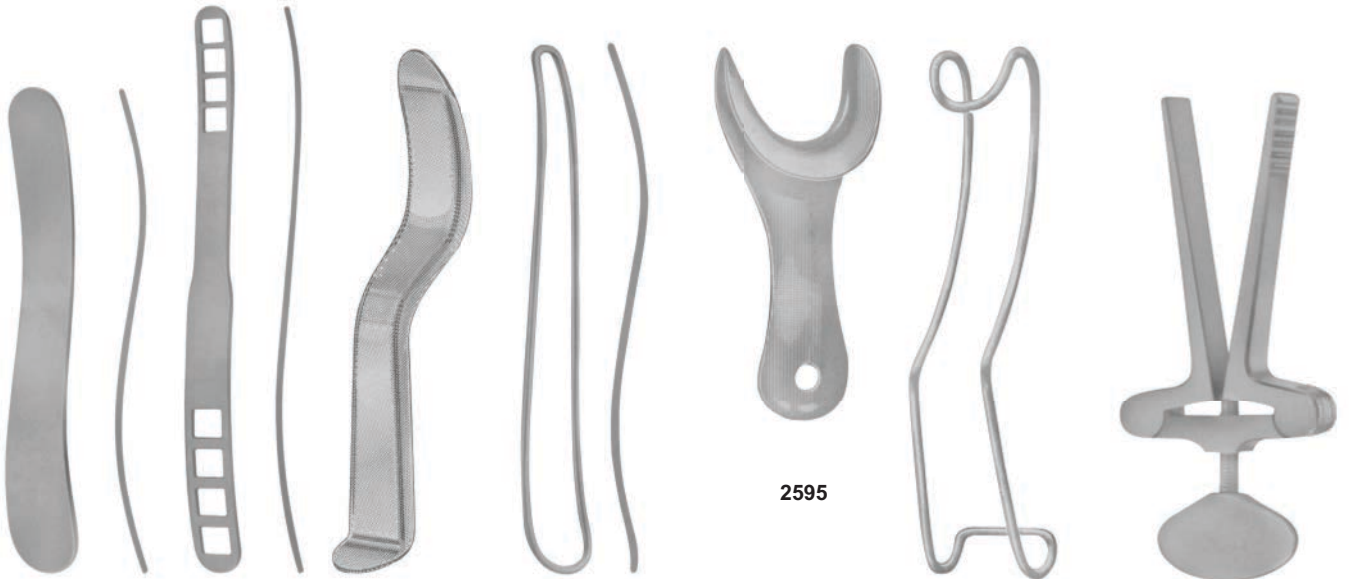

**2591**  
140 mm

**2592**  
BRUENINGS  
190 mm

**2593**

**2594**

**2595**

**2596**

**2597**

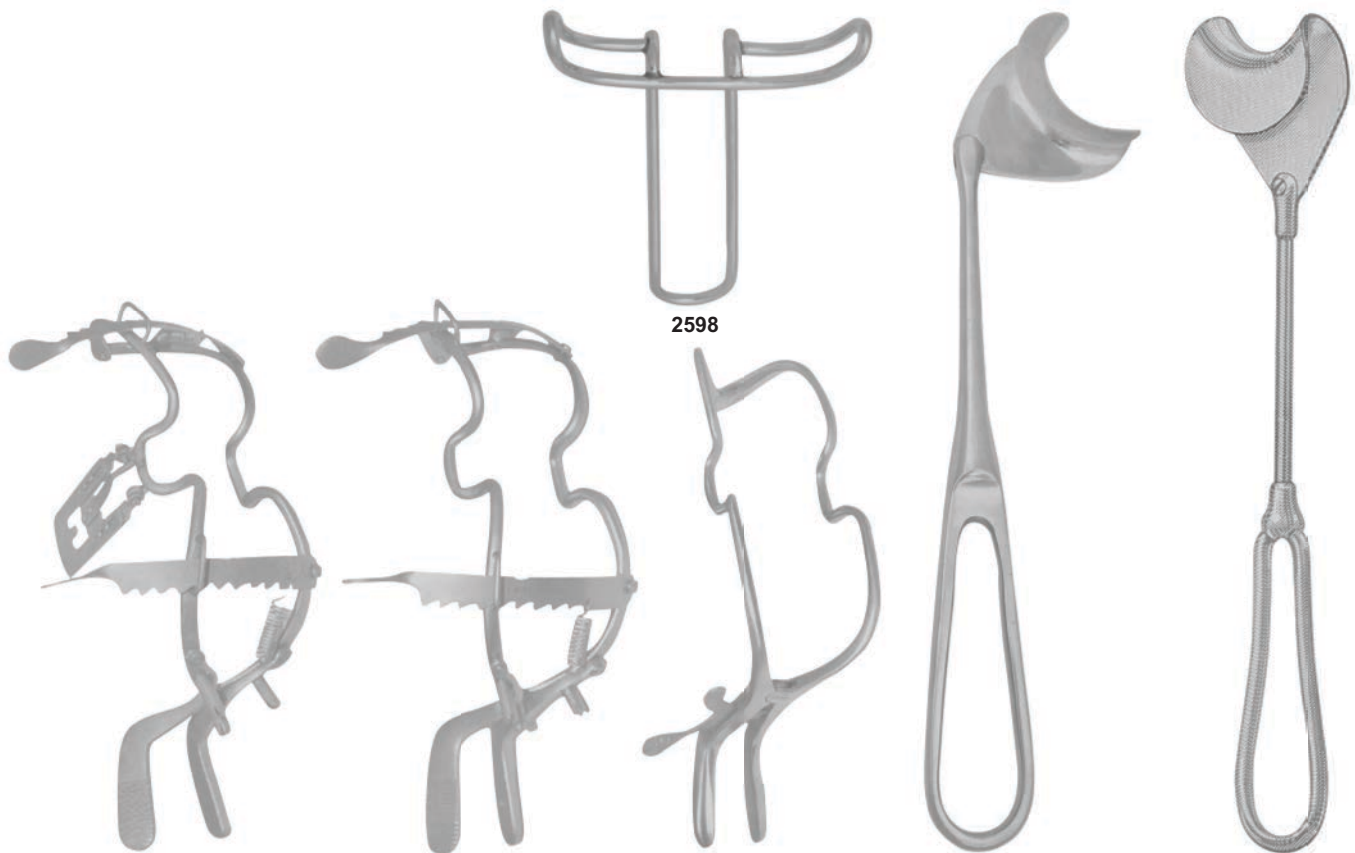

**2598**

**2599**  
Mouth Gag with  
Tongue Depressor  
11.0 cm  
13.0 cm  
15.0 cm

**2600**  
Mouth Gag without  
Tongue Depressor  
11.0 cm  
13.0 cm  
15.0 cm

**2601**  
Jennings, Mouth Gag  
11.0 cm  
13.0 cm  
15.0 cm

**2602**

**2603**

- 30 x 4 mm A
- 23 x 7 mm B
- 24 x 11 mm C
- 29 x 10 mm D
- 30 x 11 mm E
- 32 x 14 mm F
- 40 x 11 mm G
- 42 x 10 mm H
- 50 x 11 mm I
- 55 x 11 mm J
- 60 x 11 mm K
- 70 x 11 mm L
- 70 x 14 mm M

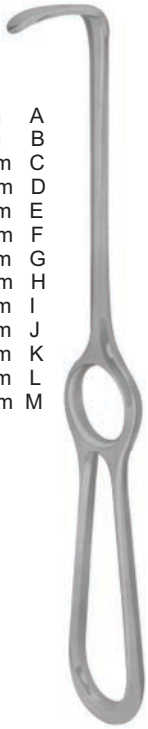

**2604**  
LANGENBECK  
210 mm



**2605**  
KOCHER-LANGENBECK  
215 mm



**2606**  
BUCHS  
205 mm



38 x 18 mm

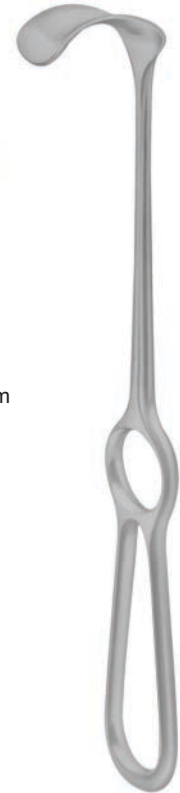

**2607**  
KOCHER  
230 mm



**2608**  
MIDDELDORPF



**2609**  
15 x 15 mm  
220 mm



**2610**  
20 x 22 mm  
215 mm



**2611**  
28 x 28 mm  
235 mm



**2612**  
KOCHER  
230 mm



**2613**  
COLLIN  
150 mm



**2614**  
ROUX  
Set  
165 mm



**2615**  
Sterilizing Forcep Curved  
20 cm A  
25 cm B  
30 cm C



**2616**  
Sterilizing Forcep Straight  
20 cm A  
25 cm B  
30 cm C



**2617**  
Sterilizing Forcep  
30 cm



**2618**  
Becht Tweezer



**2619**  
Sterilizing Forcep  
23 cm A  
30 cm B



**2620**  
Sterilizing Forcep  
20 cm







**2621**  
3 sharp prongs



**2622**  
2 sharp prongs  
6"



**2623**  
2 sharp prongs  
6"



**2624**  
FOMON  
145 mm

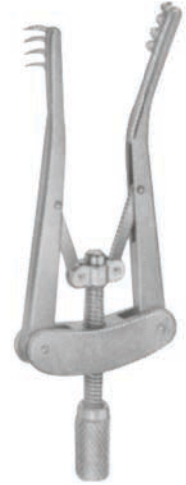

**2625**  
ALM  
70 mm



**2626**  
SENN  
3 sharp prongs  
6 3/8"



**2627**  
TOENNIS  
Dura Retractor  
150mm



**2628**  
JOSEPH  
165 mm



**2629**  
GILLIES  
180 mm



**THE AVION**  
MFG. EXPORT. CO

- ⟨☞⟩ Orthodontic Pliers
- ⟨☞⟩ Orthodontic Cutters
- ⟨☞⟩ Rongeurs
- ⟨☞⟩ Needle Holders



# 07

SECTION





**2630**  
Light Wire Cutter



**2631**  
Wire Cutter



**2632**  
Posterior Band Remover  
Long



**2633**  
Posterior Band Remover  
Short



**2634**  
Jarabak Plier  
Short



**2635**  
Distal End Cutter  
Safety End Cutter



**2636**  
Distal End Cutter



**2637**  
Kim's Plier



**2638**  
Loop Forming Plier

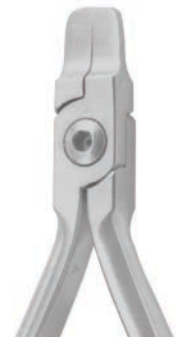

**2639**  
Tweed Arch Bending Plier



**2640**  
Utility Plier



**2641**  
Bonding Bracket Remover



**2642**  
Lingual Arch Plier



**2643**  
Light Wire Plier



**2644**  
Wire Cutter  
12.5 cm

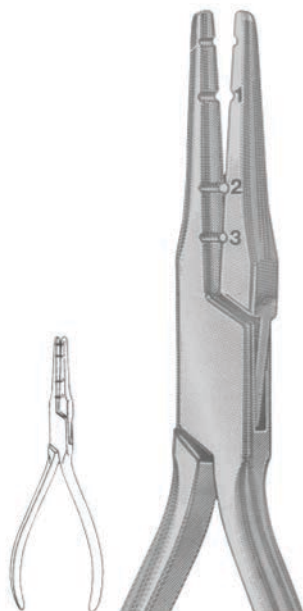

**2645**  
Fig. 101  
Wire Bending

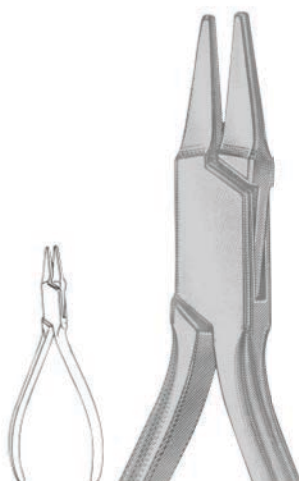

**2646**  
Fig. 118  
PEESO  
Collar

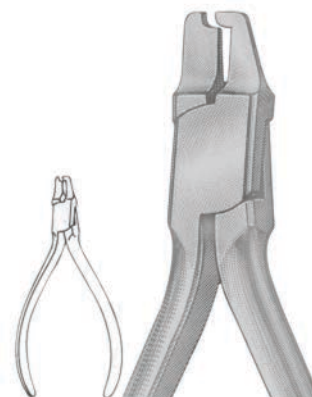

**2647**  
Fig. 417  
Crown Shell

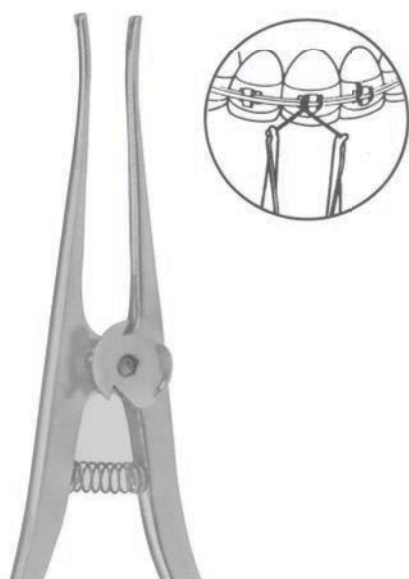

**2648**  
STEINER  
150 mm  
Ligature Pliers

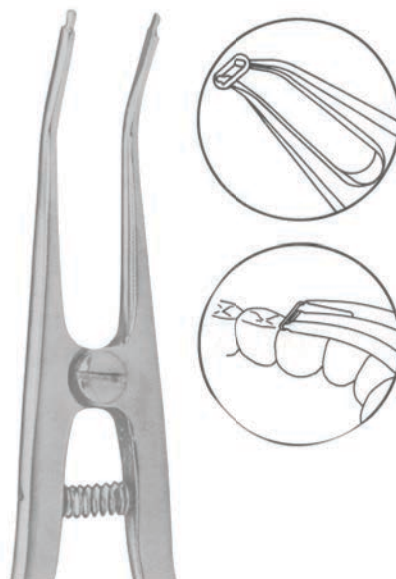

**2649**  
Separating Pliers Elastics  
150 mm



**2650**  
121-Lab & Office



**2651**  
How Plier-Titanium Alloy  
With special coated beaks



**2652**  
How Plier  
Tips are 1/8"(3.2mm)  
diameter



**2653**  
How Plier  
Tips are 1/8"(3.2mm)  
diameter



**2654**  
How Plier-Small  
Tips are 3/32"(2.4mm)  
diameter



**2655**  
How Plier-Offset  
Tips are 1/8"(3.2mm)  
diameter



**2656**  
Weingart Utility Plier  
-Titanium Alloy  
with special coated beaks

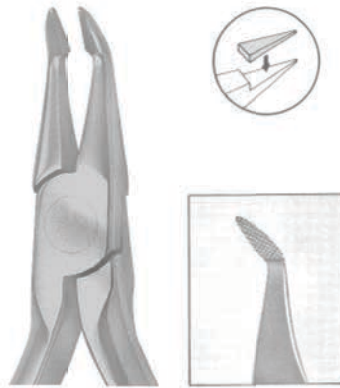

**2657**  
Weingart Utility Plier  
New type of the Weingart Utility Plier  
designed for a more precise operation.



**2658**  
Weingart Utility Plier

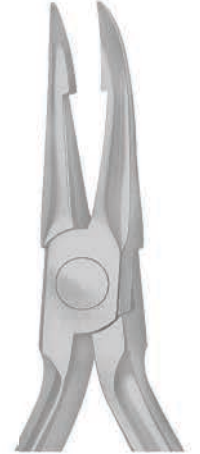

**2659**  
Weingart Utility Plier

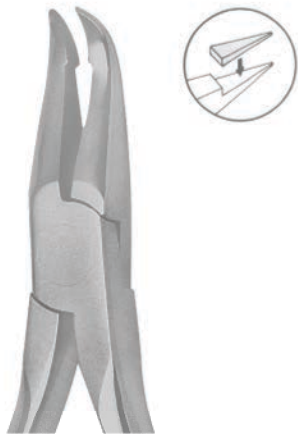

**2660**  
Weingart Utility Plier

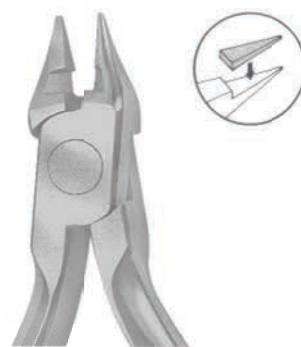

**2661**  
Bird Beak Plier With Cutter  
**Maximum Bending & Cutting Capacity:**  
Wires up to .032"

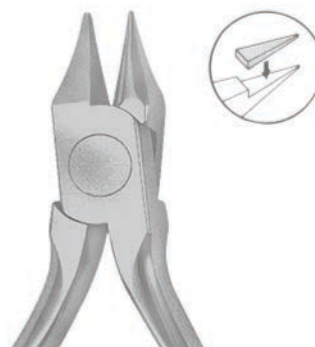

**2662**  
Bird Beak Plier  
**Maximum Bending Capacity:**  
Wires up to .032"



**2663**  
Bird Beak Plier  
**Maximum Bending Capacity:**  
Wires up to .030"



**2664**  
TWEED (Fig. 98)  
13 cm, 5 1/8"  
Tweed Loop Omega Pliers.



**2665**  
TWEED - (Fig. 90)  
14 cm, 5 1/2"



**2666**  
O'BRIEN - (Fig. 97)  
14 cm, 5 1/2"



**2667**  
TWEED (Fig. 96)  
14 cm, 5 1/2"



**2668**  
TWEED (Fig. 95)  
13.5 cm, 5 1/4"

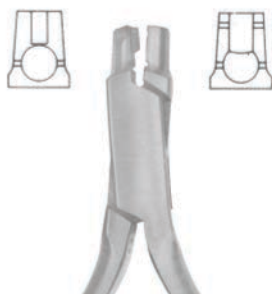

**2669**  
SCHWARZ (Fig. 29)  
12.5 cm, 5"



**2670**  
NANCE (Fig. 80)  
13 cm, 5 1/8"



**2671**  
YOUNG (Fig. 55)  
13 cm, 5 1/8"



**2672**  
SCHWARZ (Fig. 30)  
13 cm, 5 1/8"



**2673**  
Optical Plier (Fig. 53)  
14 cm, 5 1/2"

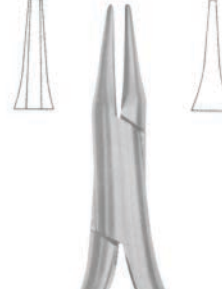

**2674**  
Schwarz (Fig. 79)  
13.5 cm, 5 1/4"



**2675**  
NANCE (Fig. 56)  
12.5 cm, 5"  
Wire bending Pliers



**2680**  
14.0 cm  
Goslee Contouring Plier



**2676**  
JOHNSON (Fig. 59)  
13.5 cm, 5 1/4"  
Contouring Plier.



**2677**  
REYNOLDS (Fig. 61)  
13 cm, 5 1/8"  
Contouring Plier.



**2678**  
De La Rosa (Fig. 34)  
12.5 cm, 5"  
Contouring Plier, Non-Grooved



**2679**  
De La Rosa (Fig. 35)  
12.5 cm, 5"  
Contouring Plier, Grooved



**2681**  
14.0 cm  
Goslee Contouring Plier

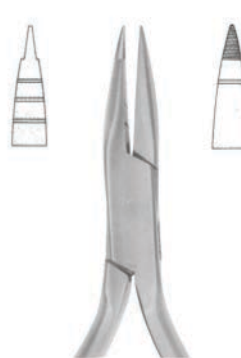

**2682**



**2683**  
Fig. 58  
12.5 cm, 5"  
Lingual Arch Bending Plier

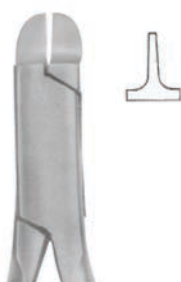

**2684**  
Frevert/Tweed (Fig. 51)  
12.5 cm, 5"  
Tweed Arch Plier/Standard Jaw

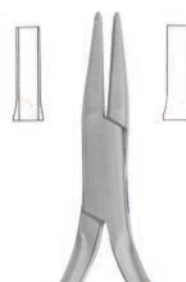

**2685**



**2686**  
ANGLE (Fig. 52)  
13 cm, 5 1/8"  
Arch Forming Plier



**2687**  
Fig. 60  
13 cm, 5 1/8"  
Wire & Clasp Bending Pliers



**2688**  
Fig. 60  
13 cm, 5 1/8"  
Wire & Clasp Bending Pliers

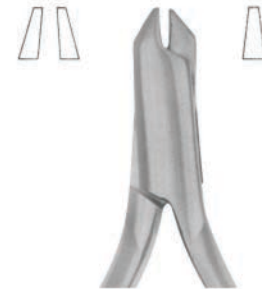

**2689**  
Aderer (Fig. 57)  
12 cm, 4 3/4"  
Wire & Clasp Bending Pliers



**2690**  
49 e 49 TC  
14 cm, 5 1/2"  
Band Removing Plier, short pad



**2691**  
50 e 50 TC  
14 cm, 5 1/2"  
Band Removing Plier, long pad



**2692**  
Fig. 84  
14.5 cm, 5 3/4"  
Band pinshing & ligature  
locking plier, serrated



**2693**  
Fig. 72  
14 cm, 5 1/2"  
Band pinshing & ligature  
locking plier, serrated



**2694**  
BRACKET (Fig. 82)  
13.5 cm, 5 1/4"  
Direct Bonding Bracket Remover



**2695**  
BRACKET (Fig. 83)  
13.5 cm, 5 1/4"  
Direct Bonding  
Bracket Remover





**2696**  
38c, 38TC  
13.5 cm, 5 1/4"  
Contouring closing loop pliers,  
wire bending, cutter.

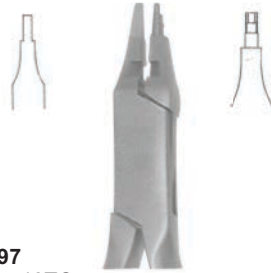

**2697**  
40c, 40TC  
13.5 cm, 5 1/4"  
Contouring pliers light wire pliers  
grooved with cutter.

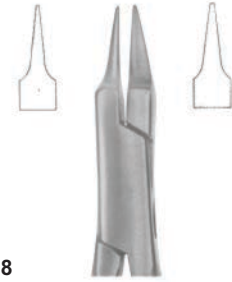

**2698**  
Fig. 81  
12.5 cm, 5"  
Sling clasp & wire bending plier



**2699**  
Fig. 28  
14 cm, 5 1/2"  
Sling clasp & wire bending plier.



**2700**  
Fig. 21  
13 cm, 5 1/8"  
Light wires pliers, grooved



**2704**  
46c - 46 TC  
ADAMS - N. 139c  
12.5 cm, 5"  
Bird beak with cutter.



**2701**  
ADAMS, 23, 23TC  
12.5 cm, 5"  
Sling clasp & wire bending plier.



**2702**  
ADAMS (Fig. 33)  
12.5 cm, 5"  
For retaining elements.



**2703**  
ADAMS (Fig. 44)  
12.5 cm, 5"  
Sling clasp & wire bending plier.



**2705**  
Universal Wire Bending  
Pliers (ADAMS) 47 TC, N.64  
12.5 cm, 5"  
Sling clasp & wire bending plier.



**2706**  
86c, 86 TC  
Angle Bird Beak - N.138  
12.5 cm, 5"  
Sling clasp & wire bending plier.



Ø 1.0 mm  
(0.40")

**2707**  
Fig. 18 TC  
15 cm, 6"



Ø 1.0 mm  
(0.40")

**2708**  
Fig. 92 TC  
14 cm, 5 1/2"



Ø 0.4 mm  
(0.16")

**2709**  
Fig. 91 TC  
13 cm, 5 1/8"



Ø 0.4 mm  
(0.16")

**2710**  
Fig. 99 TC  
13 cm, 5 1/8"



Ø 0.4 mm  
(0.16")

**2711**  
Fig. 94 TC  
13 cm, 5 1/8"  
Angled at 15° with or  
without spring on \  
the handles.



**2712**  
Fig. 85 TC  
13 cm, 5 1/8"



**2713**  
Fig. 87 TC  
13 cm, 5 1/8"



**2714**  
Fig. 85 TC  
Angled at 15°  
13 cm, 5 1/8"



**2715**  
ADAMS 87 TC  
Angled at 15°  
13 cm, 5 1/8"





**2721**  
UNIVERSAL  
150 mm

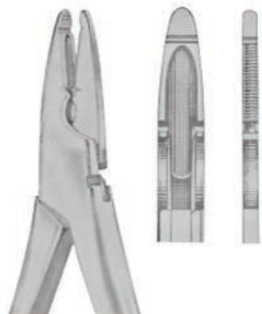

**2722**  
WALDSACHS  
155 mm



**2723**  
ADERER  
125 mm

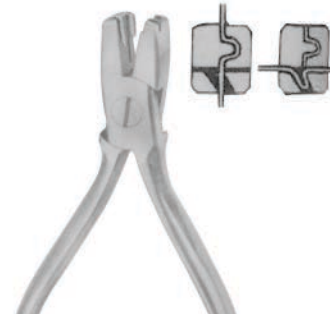

**2724**  
NANCE  
125 mm

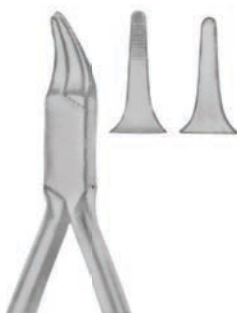

**2725**  
REYNOLDS  
125 mm



**2726**  
HOW  
145 mm



**2727**  
HOW  
140 mm



**2731**  
FURRER  
150 mm



**2728**  
WALDRON  
125 mm

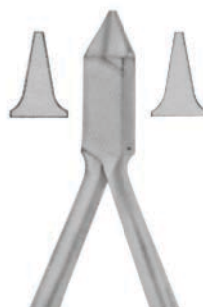

**2729**  
ADAMS  
125 mm



**2730**  
ANGLE  
125 mm

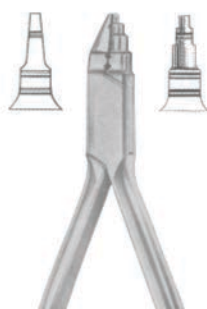

**2732**  
YOUNG  
130 mm



**2733**  
NANCE  
130 mm



**2734**  
LANGEBECK  
125 mm

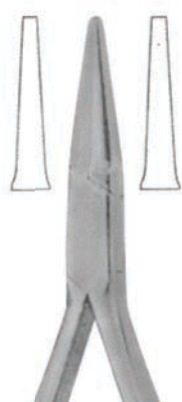

**2735**  
LANGEBECK  
140 mm

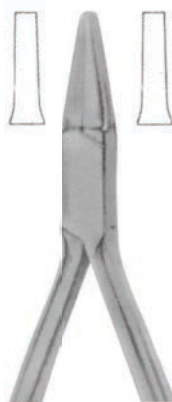

**2736**  
LANGEBECK  
130 mm

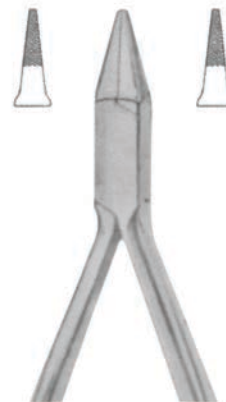

**2737**  
PEESO  
125 mm



**2738**  
GOSLEE  
125 mm

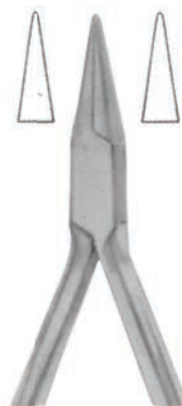

**2739**  
FISCHER  
140 mm



**2740**  
FISCHER  
140 mm



**2741**  
JOHNSON  
130 mm



**2742**  
MSY  
130 mm



**2743**  
MC KELLOPS  
155 mm



**2744**  
ANDRESEN  
130 mm

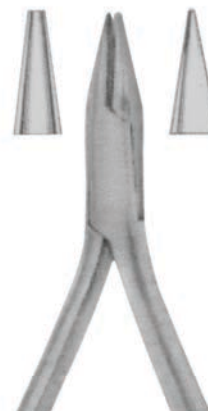

**2745**  
SCHWARZ  
130 mm



**2746**  
BLUMENTHAL  
6", 30°, Standard

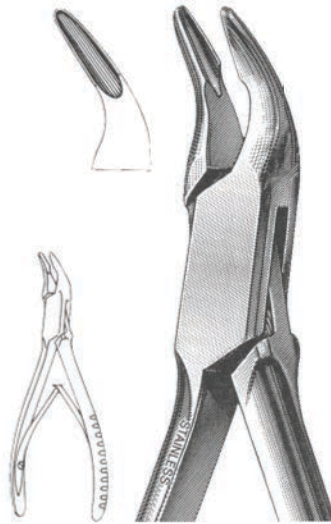

**2747**  
MINI-BLUMENTHAL  
6", 45°

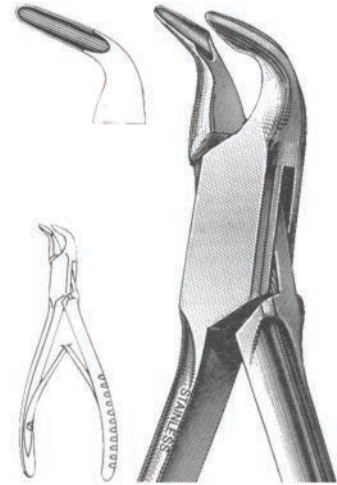

**2748**  
MINI-BLUMENTHAL  
6", 90°

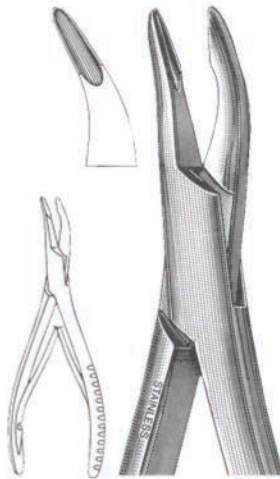

**2749**  
BLUMENTHAL  
7", 30°

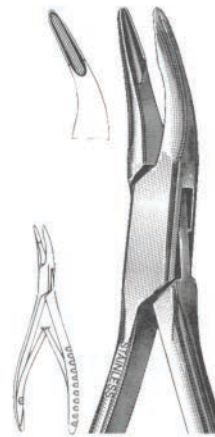

**2750**  
MINI-BLUMENTHAL  
4 1/2", 30°

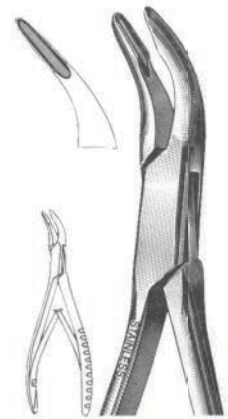

**2751**  
MINI-BLUMENTHAL  
4 1/2", 45°



**2752**  
CLEVELAND  
No. 5-Side Cutting,  
6 3/4"

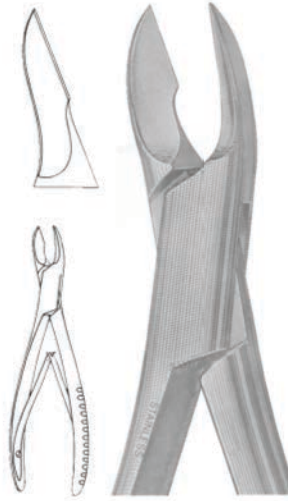

**2753**  
CLEVELAND  
No. 5A-Side Cutting,  
6 1/2"

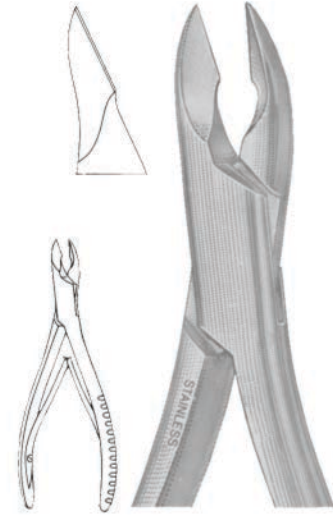

**2754**  
CLEVELAND  
No. 5S-Side Cutting,  
6"

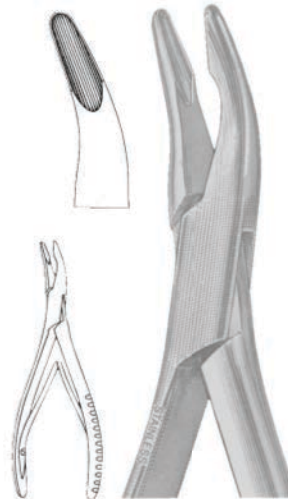

**2755**  
No. 1A-MEAD  
6 1/2"

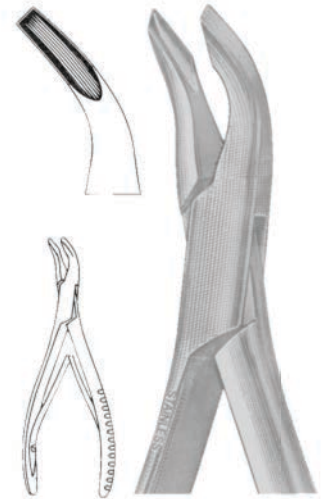

**2756**  
MEAD, Square  
No. 2A  
Tips, 6 1/2"

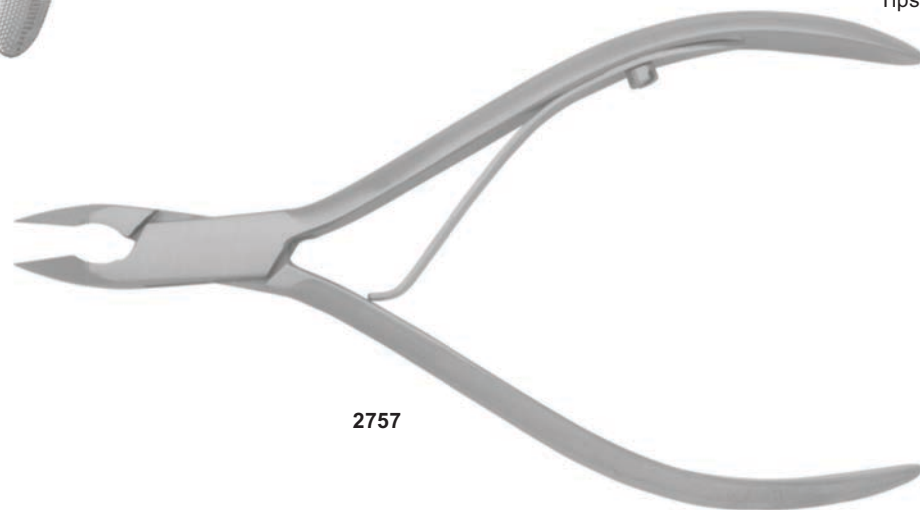

**2757**



**2757**  
FRIEDMAN  
5 1/2"

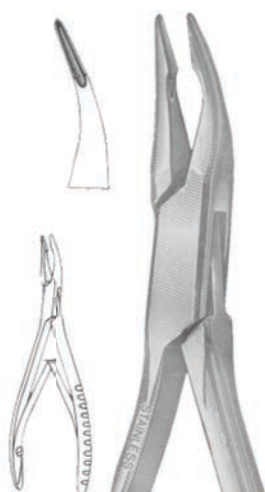

**2758**  
MICRO-FRIEDMAN  
5 1/2", 15° Curved Jaws

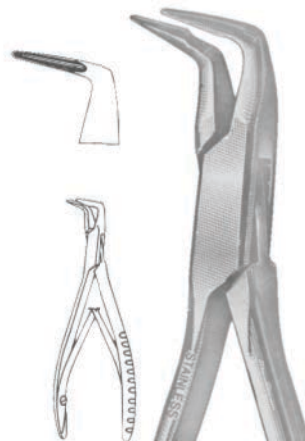

**2759**  
MICRO-FRIEDMAN  
Perio Rongeur, 5 1/2"

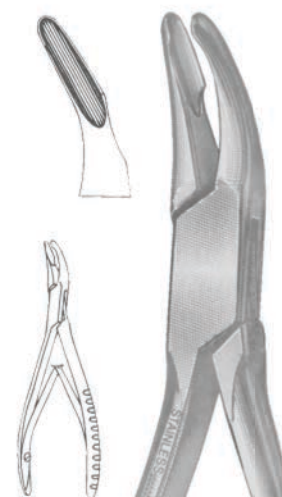

**2760**  
CLEVELAND  
No. 4 - 5 1/2"

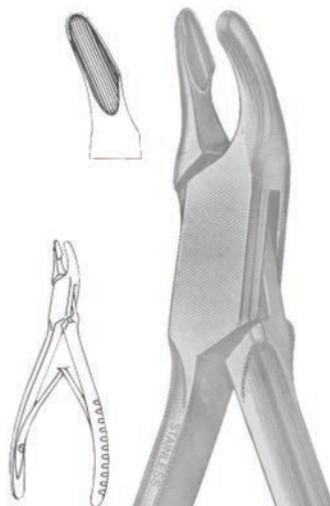

**2761**  
CLEVELAND  
No. 4A - 6 1/2"

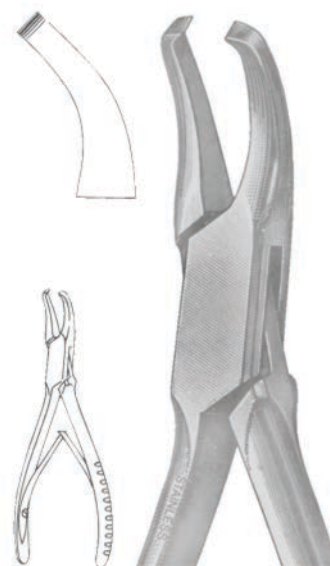

**2762**  
GARDNER  
No. 6A, End Cutting  
6 1/2"





**2763**  
BEYER  
Double Action,  
16,18 cm



**2764**  
No. 1  
6 1/2"

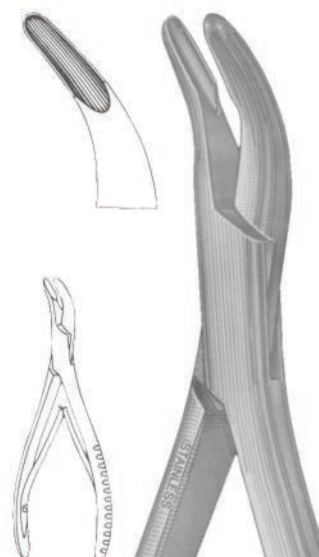

**2765**  
HARTMAN  
5 3/4"  
Strong Curve

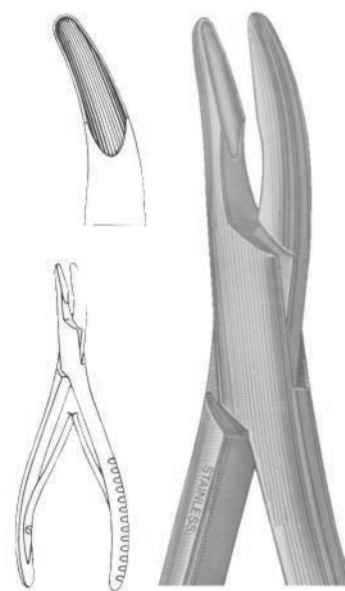

**2766**  
BANE  
Slight Curve  
7"



**2767**  
COLLIER  
5", Fenestrated Jaws



**2768**  
DERF  
4 3/4"



**2769**  
WEBSTER  
Delicate Smooth Jaws  
5"



**2770**  
NEIVERT  
One Offset Ring  
5"



**2771**  
OLSEN-HEGAR  
5 1/2"



**2772**  
BAUMGARTNER  
5 1/2"



**2773**  
CRILE-WOOD  
6"



**2774**  
GARDNER  
5"

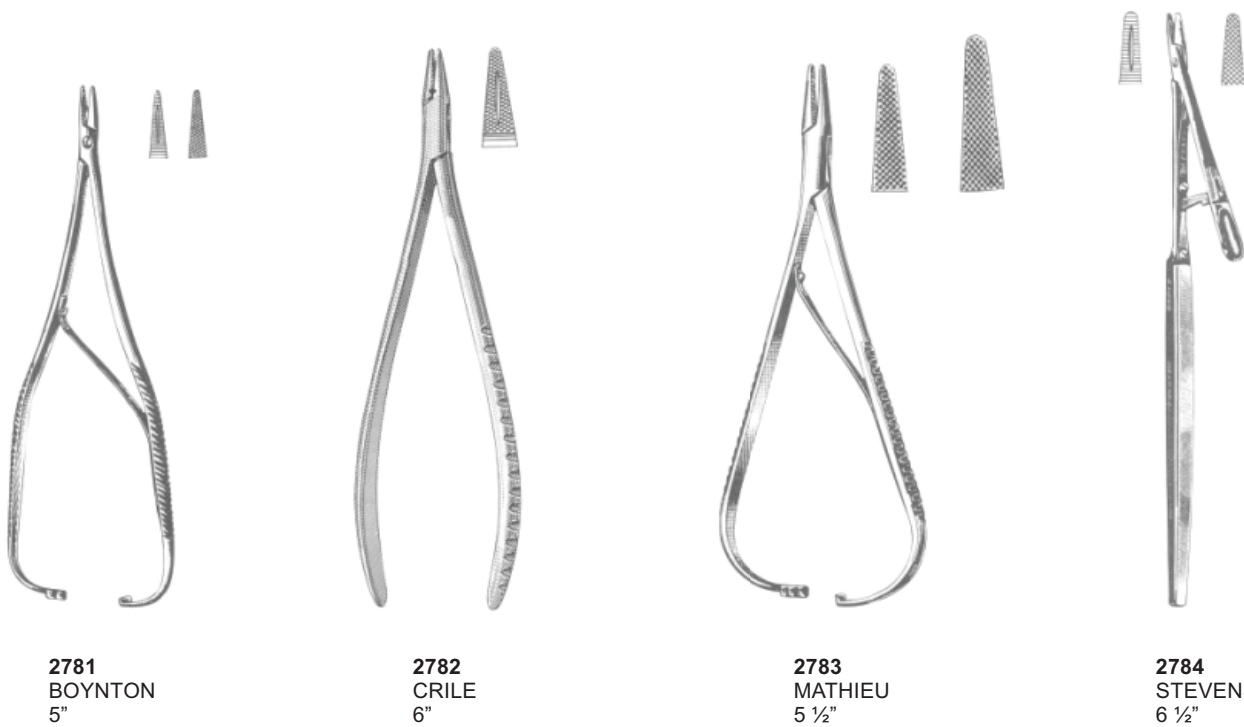
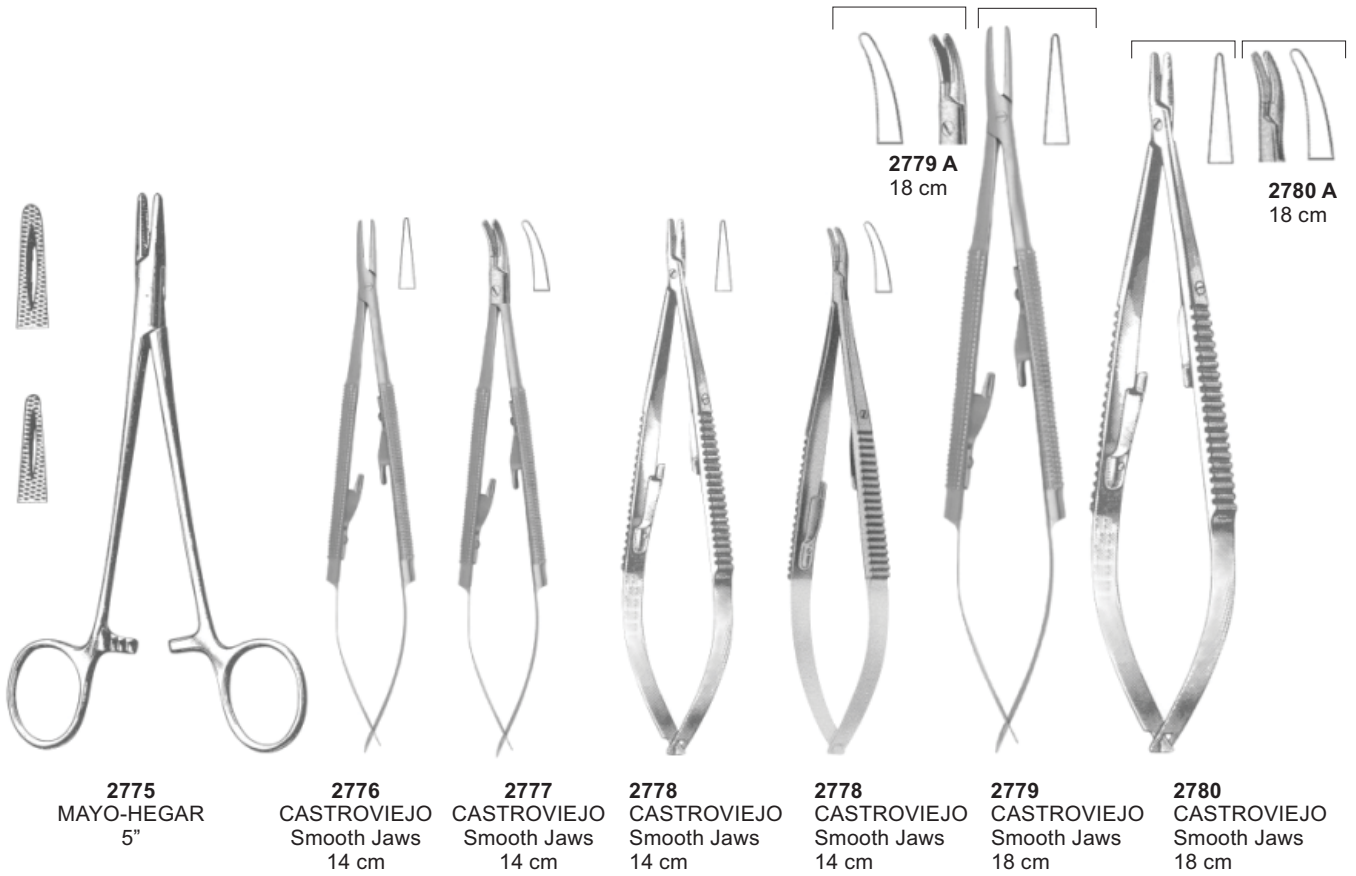



**2785**  
Micro Scissor  
Straight, 155 mm



**2786**  
Micro Scissor  
Straight, 150 mm



**2787**  
Micro Scissor  
Curved, 150 mm



**2788**  
Micro Scissor  
Curved, 155 mm

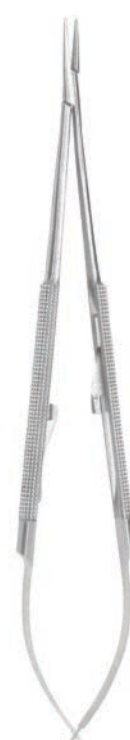

**2789**  
CASTROVIEJO  
T.C.  
Straight, 180 mm



**2790**  
Retractor  
Fig.3  
165 mm



**2791**  
Micro Adson  
120 mm



**2792**  
GERALD  
Curved,  
180 mm



**2793**  
GERALD  
Straight,  
175 mm



**2794**  
Micro Adson  
160 mm

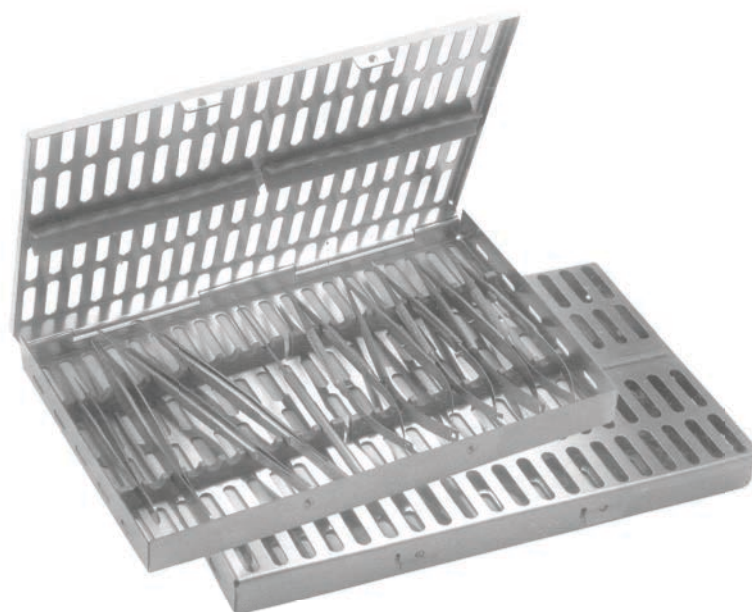

**2795**  
Micro Surgery Set 10 Pieces.



**THE AVION**  
MFG. EXPORT. CO

- ⟨☞⟩ Scissors
- ⟨☞⟩ Impression Trays
- ⟨☞⟩ Articulators
- ⟨☞⟩ Hollow Wares
- ⟨☞⟩ T.C. Instruments



# 08

SECTION



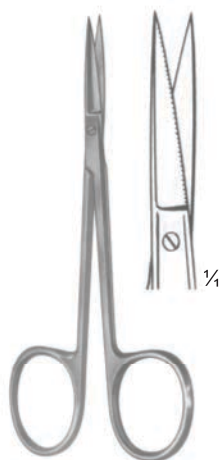

**2796**  
IRIS (Standard)  
Straight  
11.5 cm, 4 1/2"

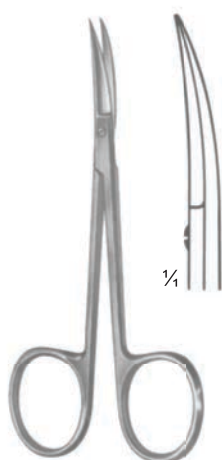

**2797**  
IRIS (Standard)  
Curved  
11.5 cm, 4 1/2"



**2798**  
STEVENS  
Dissecting Scissors  
Size: 115 mm



**2799**  
Sharp



**2800**  
Sharp



**2801**  
Blunt



**2802**  
Blunt



**2803**



**2804**  
JOSEPH  
Size: 150 mm

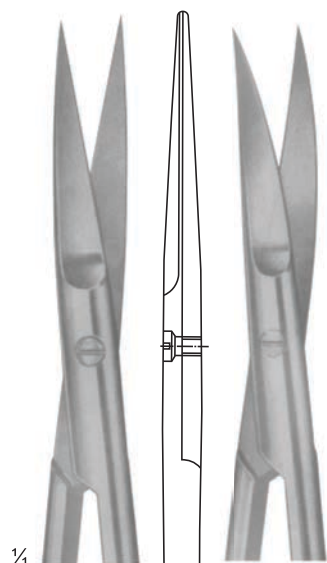

**2805**



**2806**

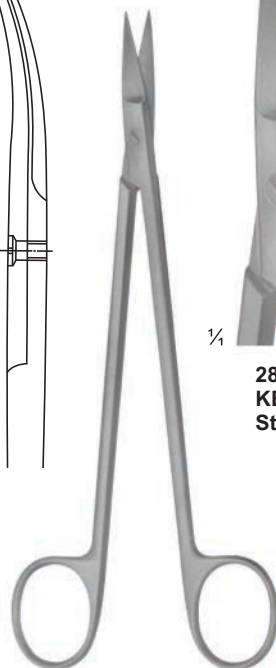

**2807**  
KELLY  
Size: 175 mm

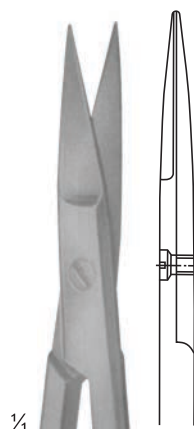

**2808**  
KELLY  
Straight

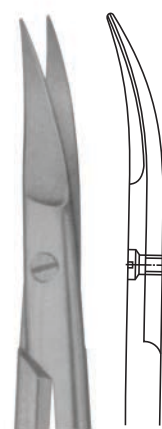

**2809**  
KELLY  
Curved

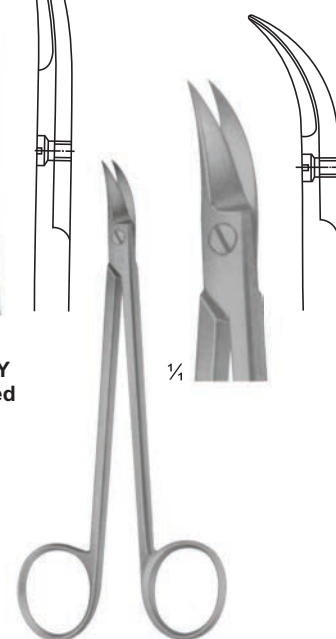

**2810**  
QUINBY  
Size: 130 mm

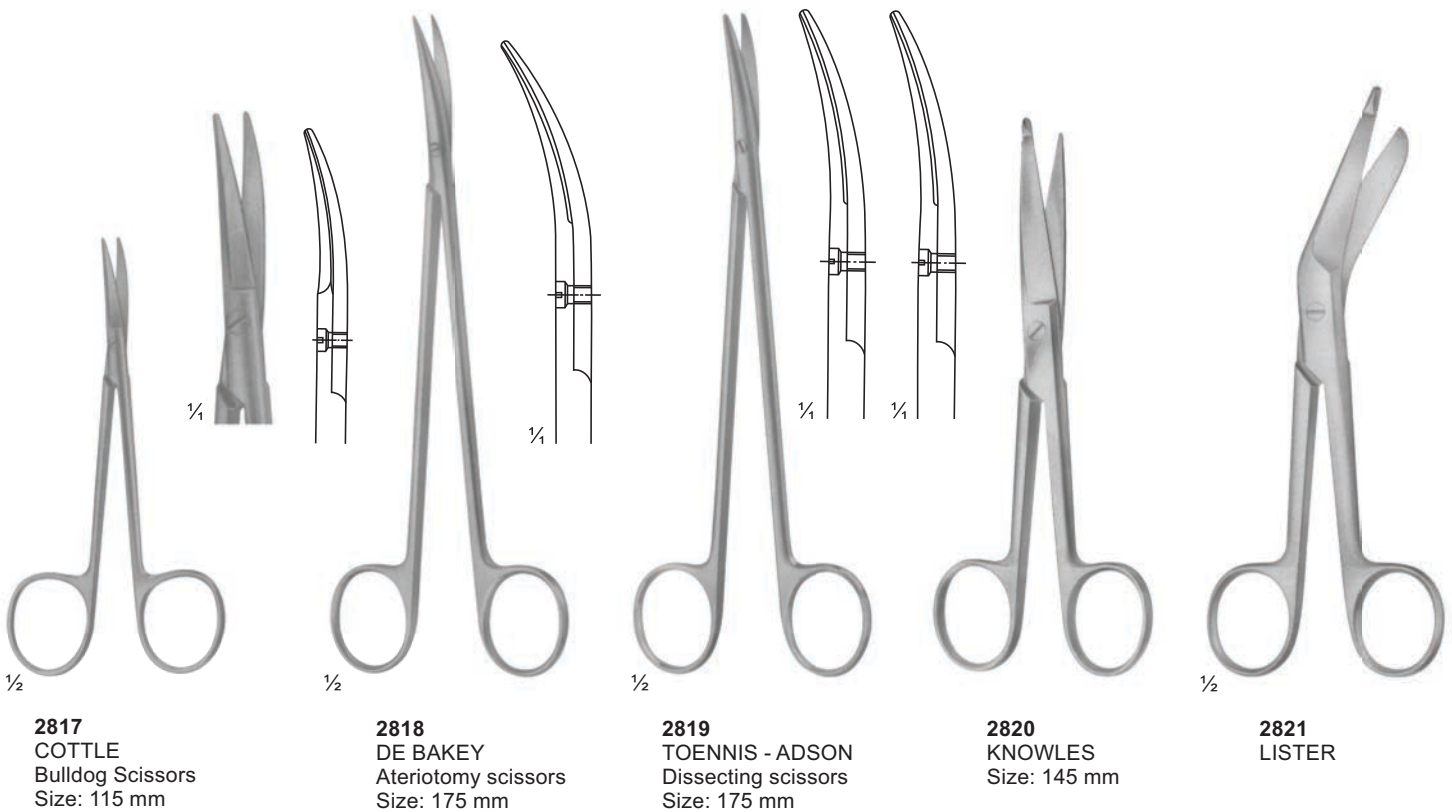
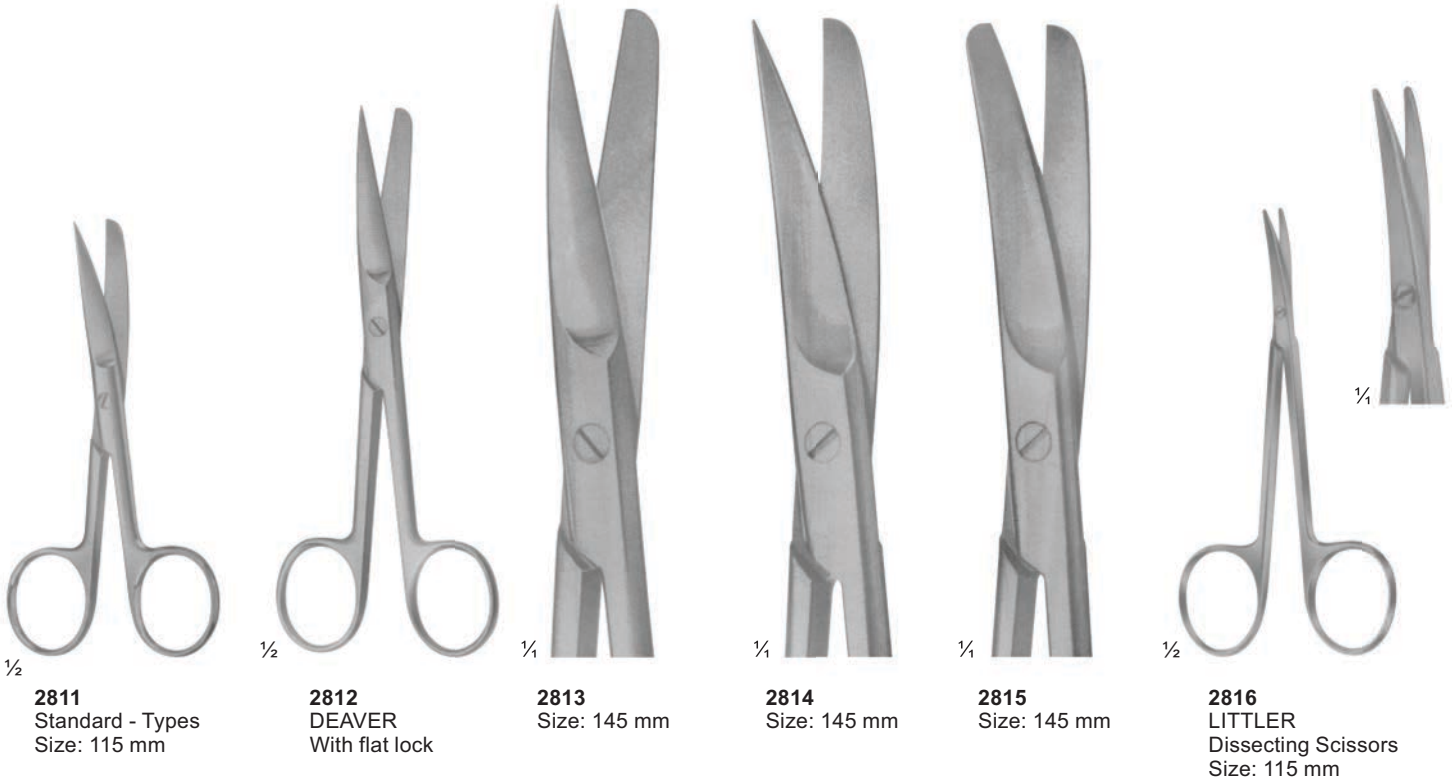

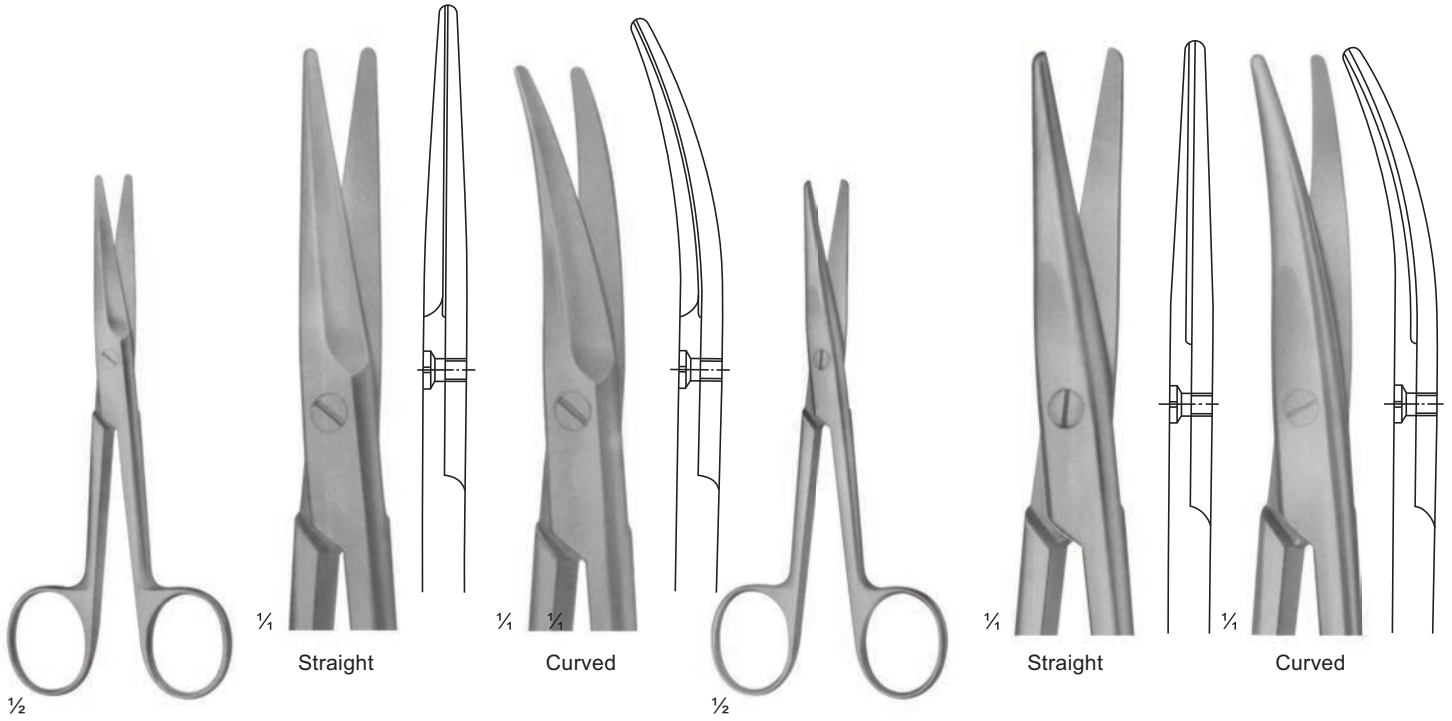

**2822**  
MAYO(straight)  
Size: 140 mm

**2823**  
MAYO-STILLE (straight)  
Size: 140 mm

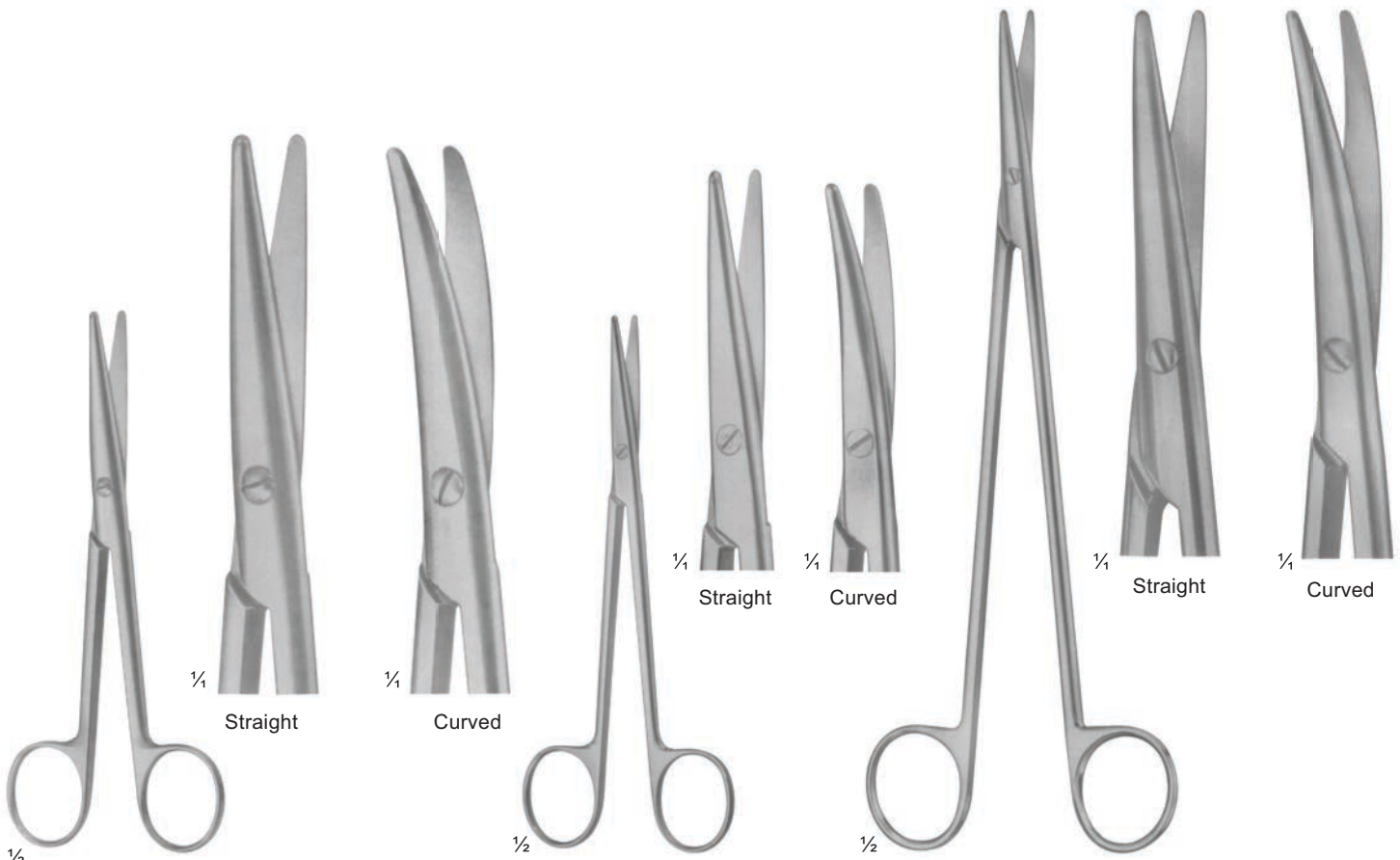

**2824**  
STILLE  
Size: 140 mm

**2825**  
METZENBAUM  
Size: 145 mm

**2826**  
NELSON-METZENBAUM  
Size: 230 mm





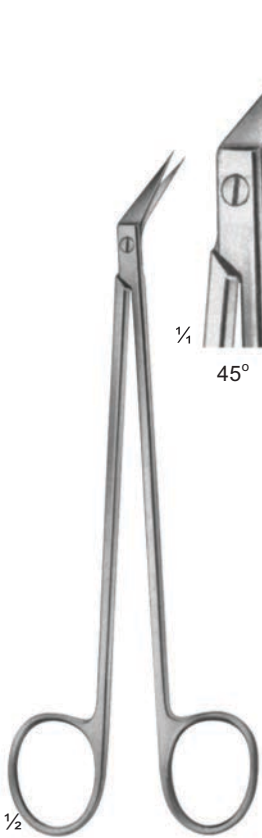

**2827**  
DE BAKEY  
Size: 155 mm

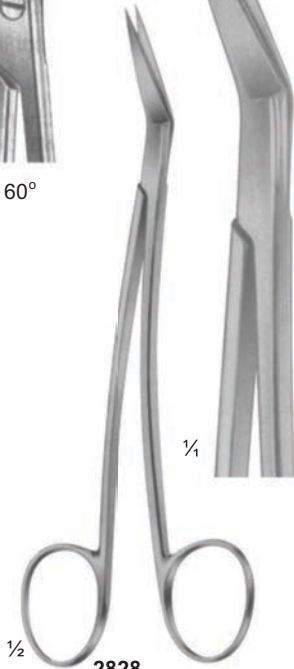
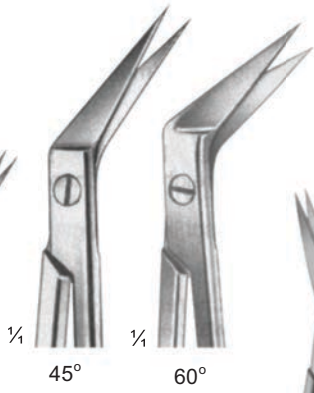

**2828**  
LOCKLIN  
Curved Sideways,  
1 Toothed Blade  
Size: 155 mm



**2829**  
LaGrange  
Double-Curved  
11.5 cm



**2830**  
Goldman-Fox  
Double-Curved  
13cm



**2831**  
SPENCER  
Size: 90 mm

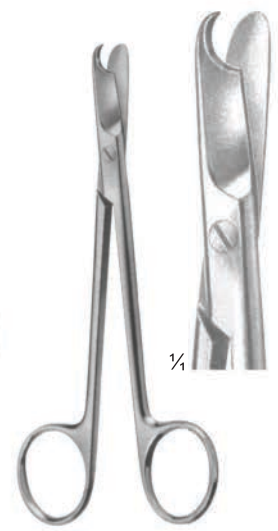

**2832**  
LITTAUER  
Size: 135 mm



**2833**  
BEEBE  
Size: 110 mm

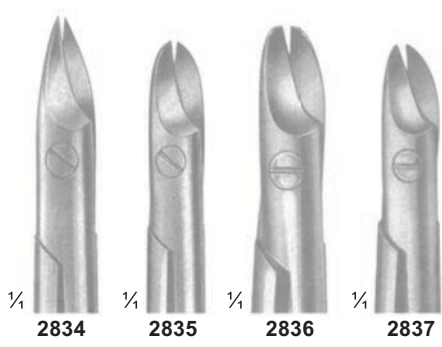

**2834**   **2835**   **2836**   **2837**



**2838**  
Dean  
17cm

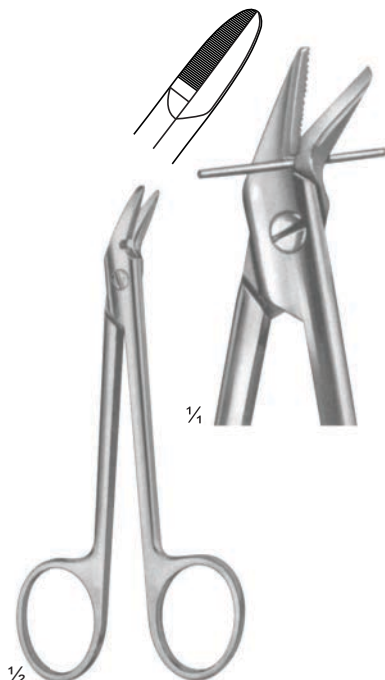

**2839**  
1 Blade Serrated  
Size: 120 mm

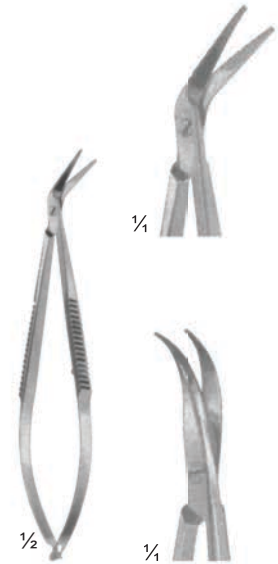

**2840**  
CASTROVIEJO  
Size: 90 mm

Made of 18/8 Stainless Steel, Solid, Set of 10

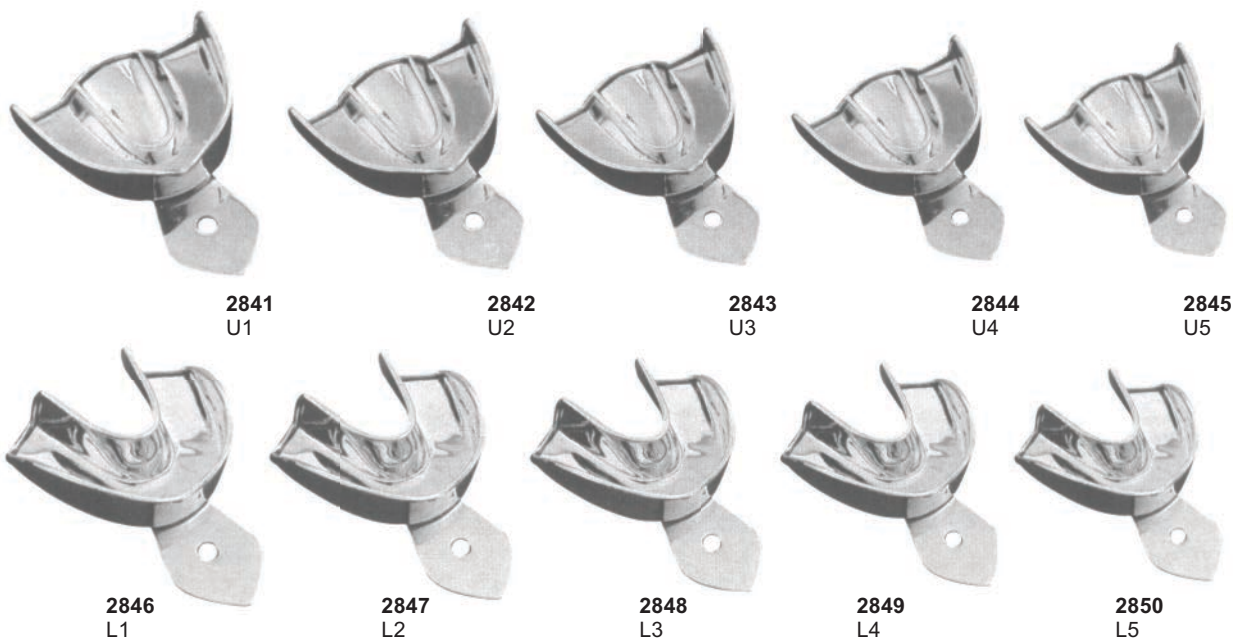

2841  
U1

2842  
U2

2843  
U3

2844  
U4

2845  
U5

2846  
L1

2847  
L2

2848  
L3

2849  
L4

2850  
L5

All The Above Impression Trays are Available in These 5 Sizes

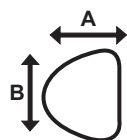

UPPER		U1	U2	U3	U4	U5
	A	62	60	53	54	52
B	83	75	73	69	68	

All Dimension are in mm

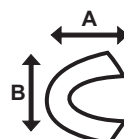

LOWER		L1	L2	L3	L4	L5
	A	63	61	57	60	53
B	82	81	78	74	71	

All Dimension are in mm

Perforated, Set of 10

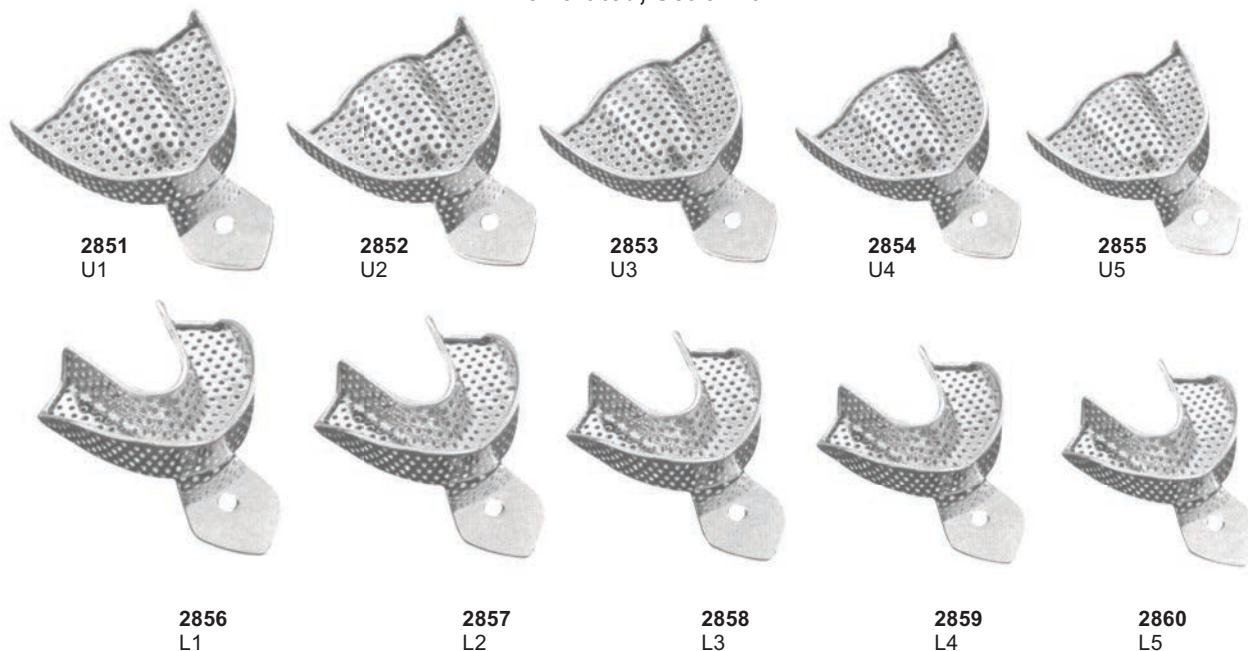

2851  
U1

2852  
U2

2853  
U3

2854  
U4

2855  
U5

2856  
L1

2857  
L2

2858  
L3

2859  
L4

2860  
L5

Made of 18/8 Stainless Steel, Solid Full Denture Set of 8

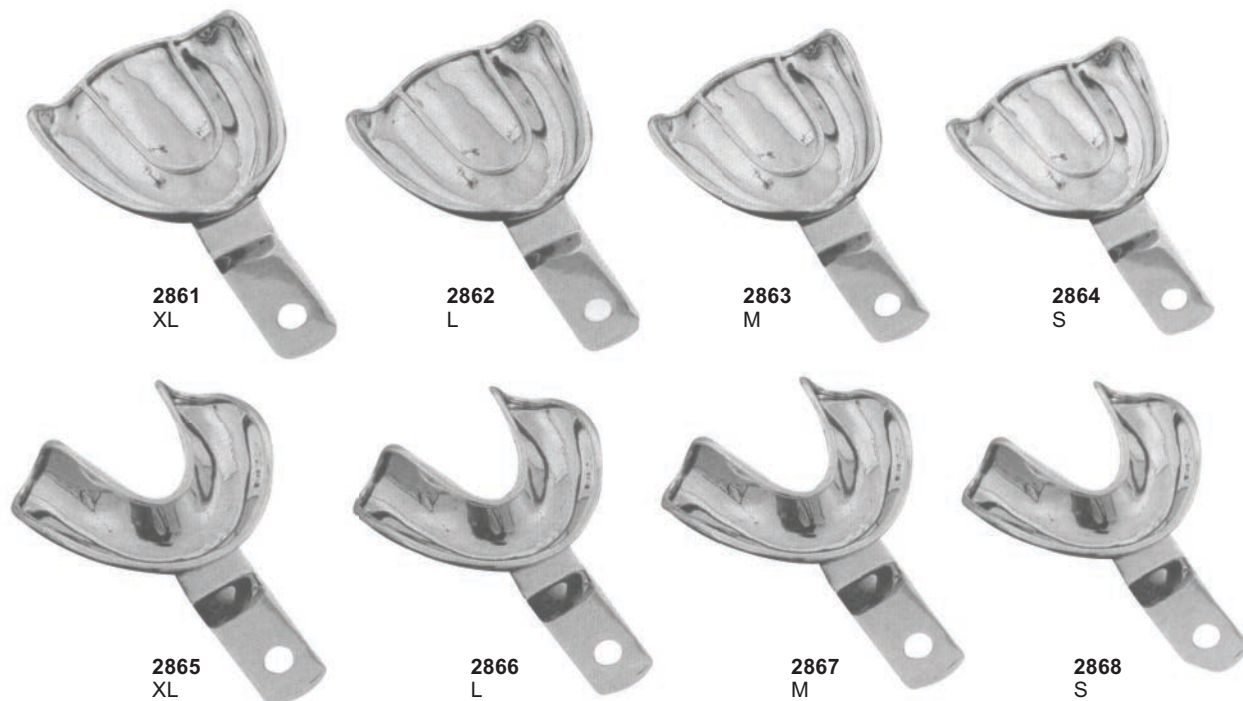

All The Above Impression Trays are Available in These 4 Sizes

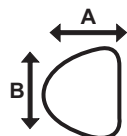

UPPER		XL	L	M	S
	A	70	67	64	60
B	79	76	70	73	

All Dimension are in mm

LOWER		XL	L	M	S
	A	64	64	60	57
B	86	70	73	70	

All Dimension are in mm

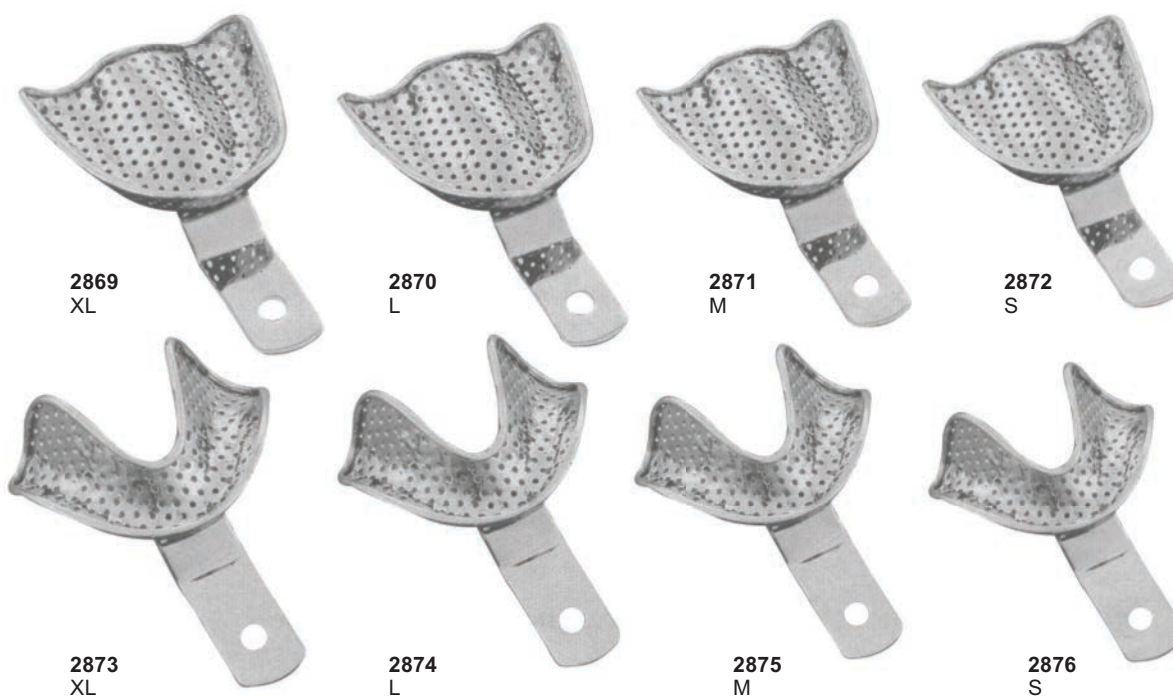
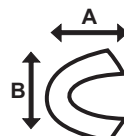

Perforated Full Denture Set of 8

Made of 18/8 Stainless Steel, Solid Set of 6

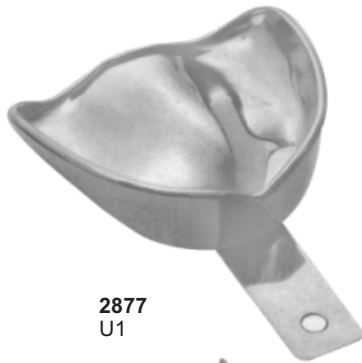

2877  
U1



2878  
U2



2879  
U3

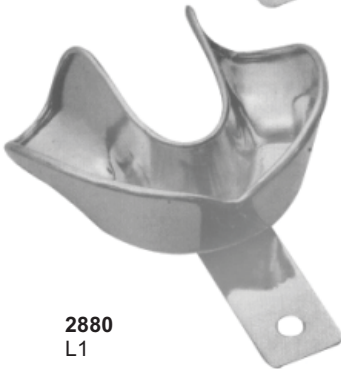

2880  
L1

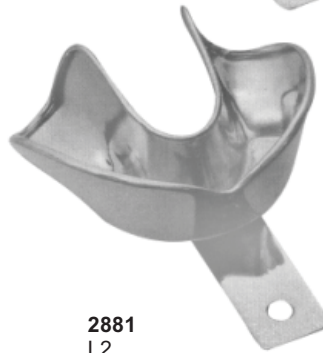

2881  
L2



2882  
L3

All The Above Impression Trays are Available in These 4 Sizes

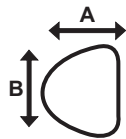

UPPER		U1	U2	U3
	A	67	64	57
B	81	71	70	

All Dimension are in mm

LOWER		L1	L2	L3
	A	60	57	54
B	81	79	76	

All Dimension are in mm

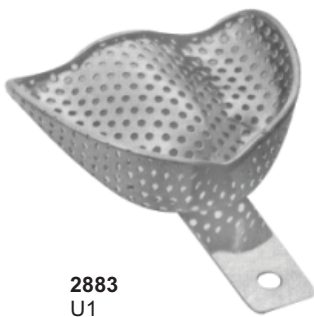

2883  
U1

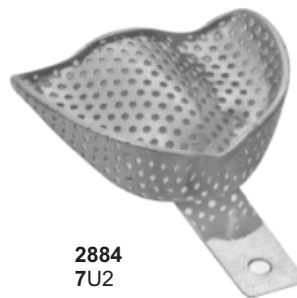

2884  
U2

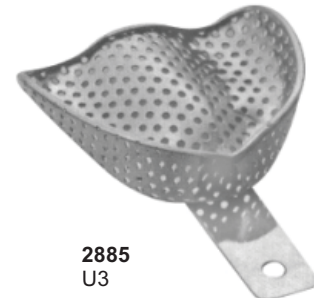

2885  
U3



2886  
L1



2887  
L2



2888  
L3

Perforated Set of 6

Made of 18/8 Stainless Steel, English Pattern Set of 8

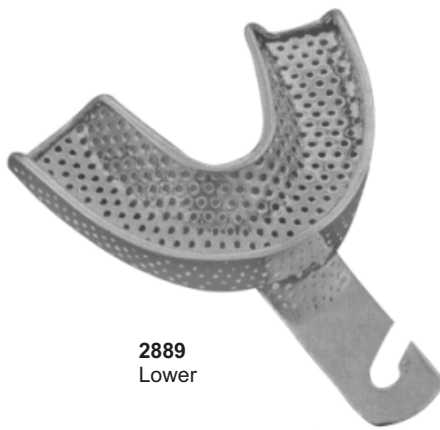

2889  
Lower



2890  
Upper

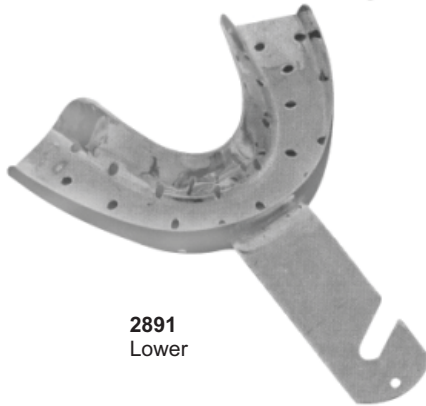

2891  
Lower



2892  
Upper



2893  
Lower



2894  
Upper

All The Above Impression Trays are Available in These 4 Sizes

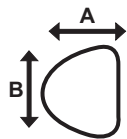

UPPER	Size	A	B	C
	0	67	50	12
	1	72	51	13
	2	78	55	15
	3	80	58	15

All Dimension are in mm

LOWER	Size	A	B	C
	0	70	50	14
	1	77	51	15
	2	79	55	15
	3	80	60	17

All Dimension are in mm

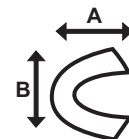

Made of 18/8 Stainless Steel, Solid Full Denture Set of 8

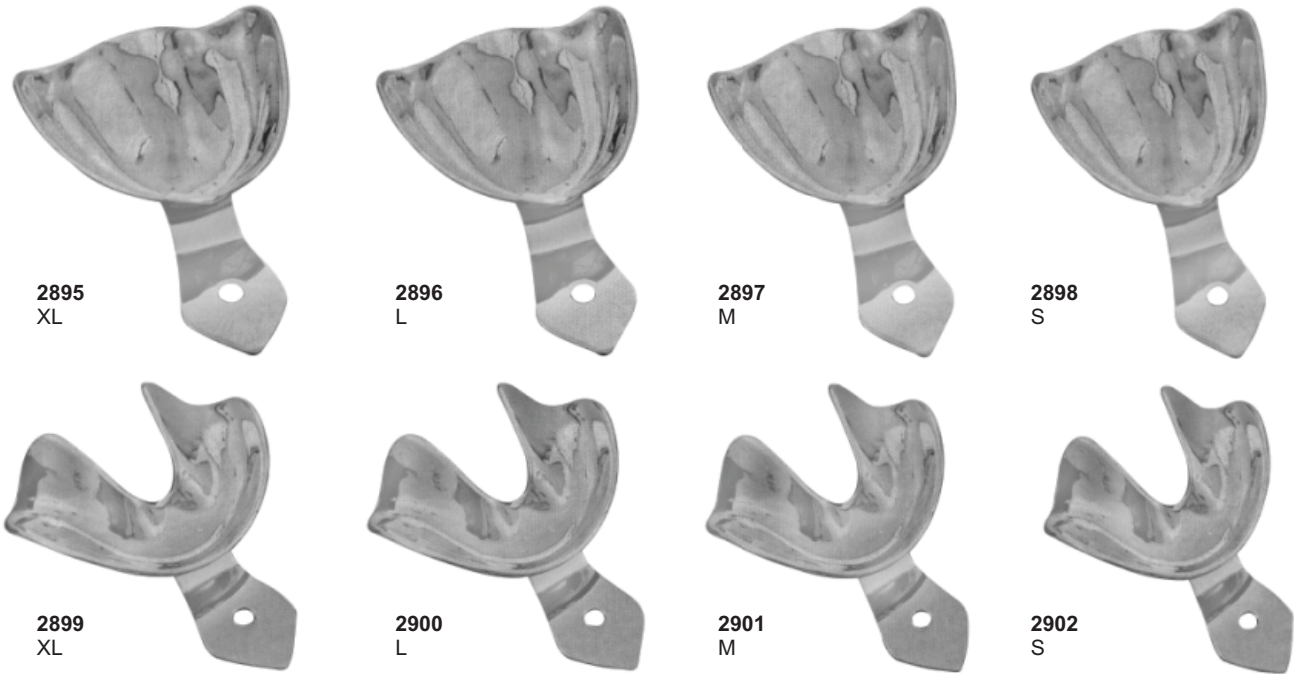

2895  
XL

2896  
L

2897  
M

2898  
S

2899  
XL

2900  
L

2901  
M

2902  
S

All The Above Impression Trays are Available in These 4 Sizes

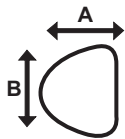

UPPER		XL	L	M	S
	A	70	67	64	60
B	79	76	70	73	

All Dimension are in mm

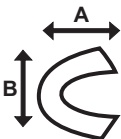

LOWER		XL	L	M	S
	A	64	64	60	57
B	86	70	73	70	

All Dimension are in mm

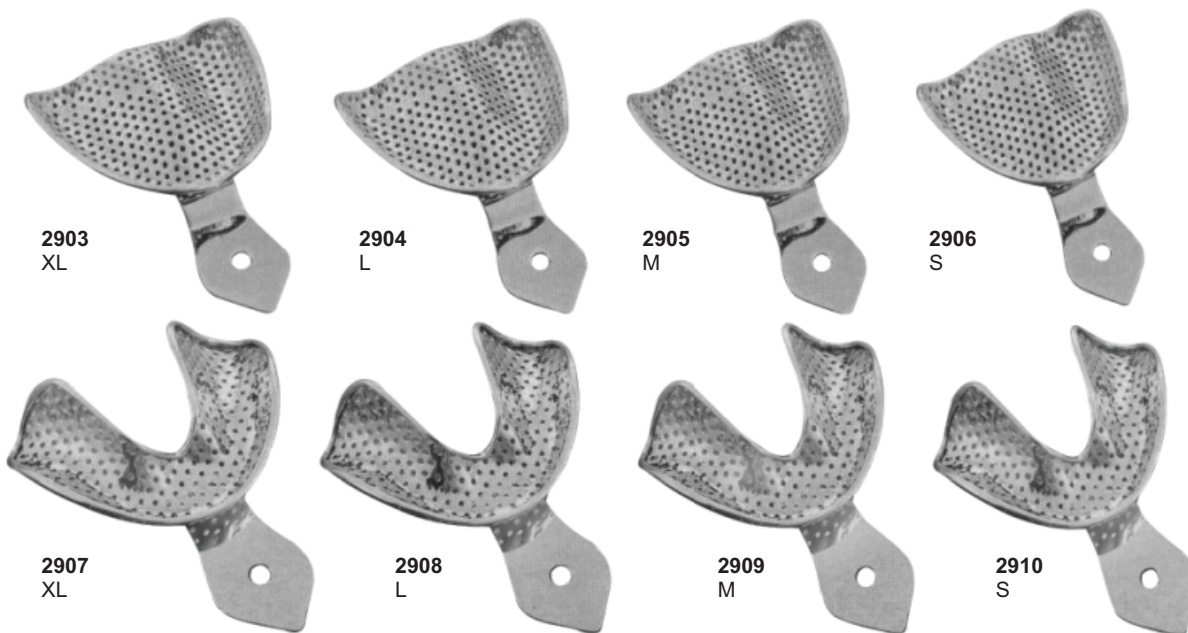

2903  
XL

2904  
L

2905  
M

2906  
S

2907  
XL

2908  
L

2909  
M

2910  
S

Made of 18/8 Stainless Steel, Perforated Full Denture Set of 8

Made of 18/8 Stainless Steel, Solid Full Denture Set of 8

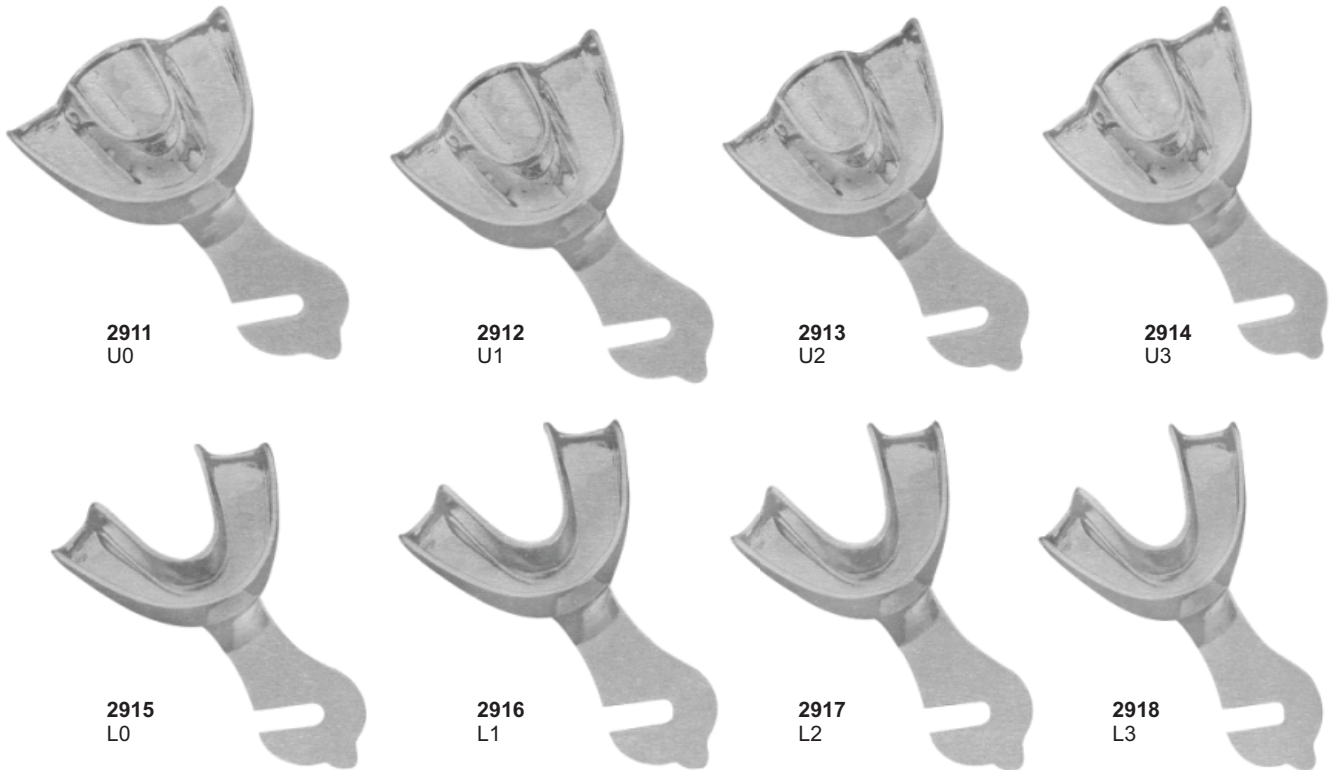

Upper Sizes: 0,1,2,3

Depth of Tray: 15,9 mm, Height of Plate: 12,5 mm

Lower Sizes: 0,1,2,3

Depth of Tray: 12,9 mm

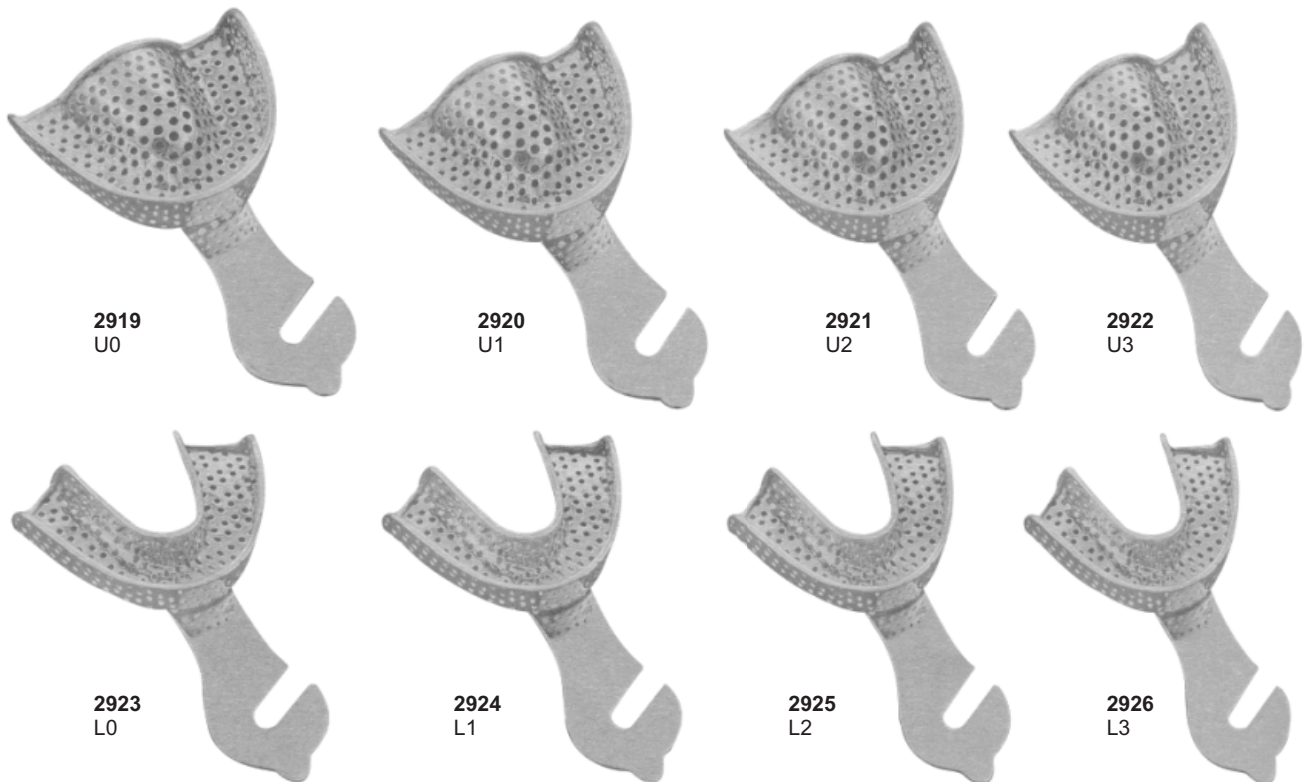

Made of 18/8 Stainless Steel, Perforated Full Denture Set of 8

## Impression Trays For Crown & Bridge Work

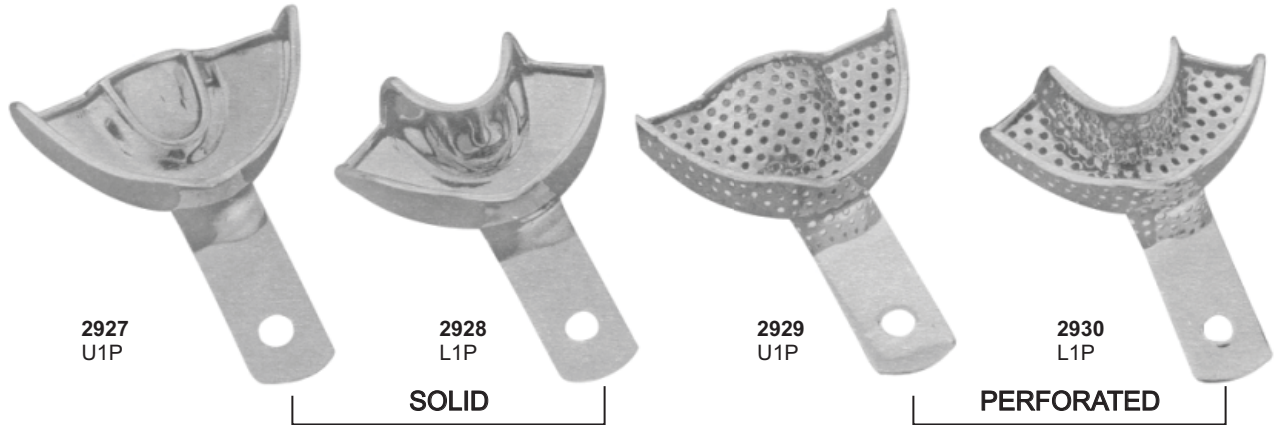

2927  
U1P

2928  
L1P

2929  
U1P

2930  
L1P

SOLID

PERFORATED



2932  
Adjustable  
Perforated



2933  
Adjustable  
Solid

PERFORATED

SOLID



2931-A  
For upper right jaw  
For lower left jaw

2931-B  
For upper left jaw  
For lower right jaw



2931-C  
For upper right jaw  
For lower left jaw

2931-D  
For upper left jaw  
For lower right jaw

**Available in 4 sizes**

- 1.....44 mm
- 2.....55 mm
- 3.....60 mm
- 4.....65 mm

**Available in 4 sizes**

- 1.....44 mm
- 2.....55 mm
- 3.....60 mm
- 4.....65 mm





# Articulators



2934



2935

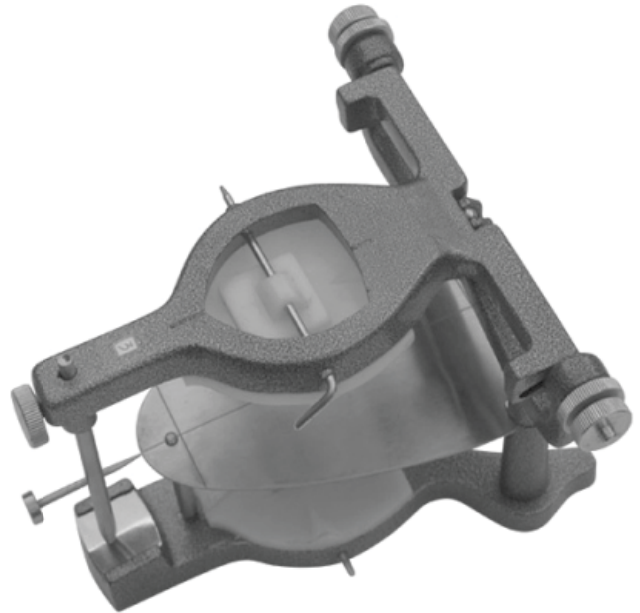

2936



2937



2939

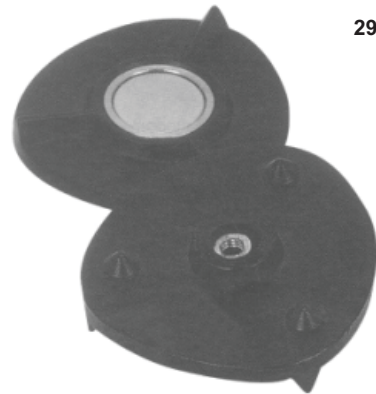

2938



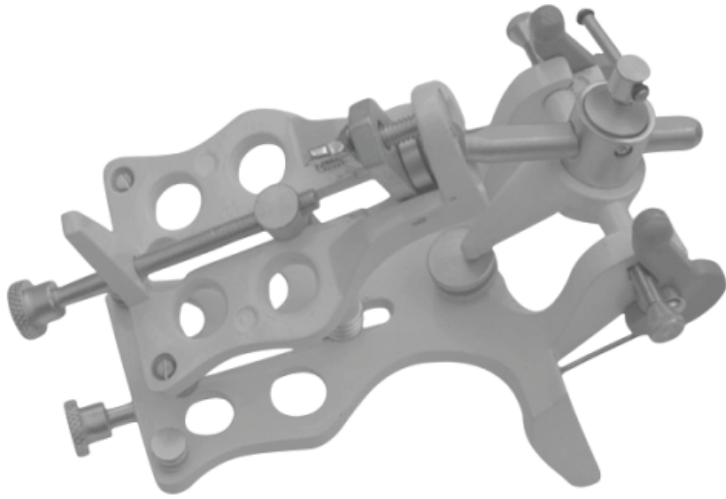

2940



2941



2942



2943

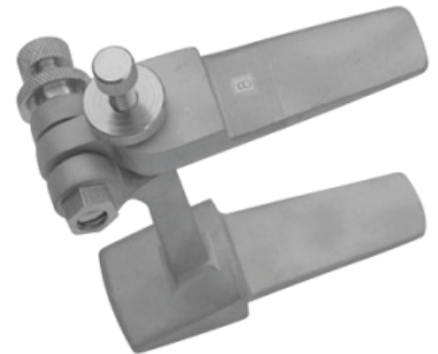

2944



2945



2946



2947

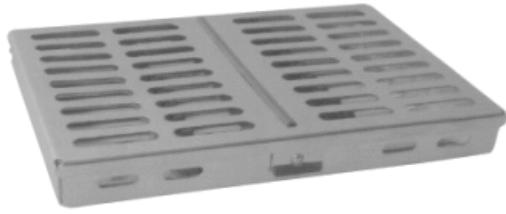

**2948**  
Instruments Tray of 20 Pcs

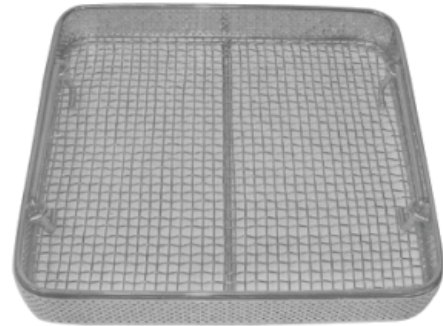

**2951**  
Instruments Riddle



**2949**  
Instruments Tray of 7 Pcs



**2949-A**  
Instruments Tray of 10 Pcs

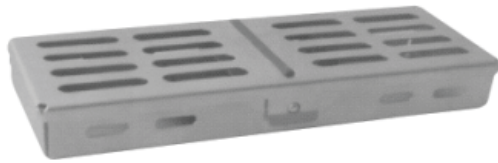

**2950**  
Instruments Tray of 5 Pcs

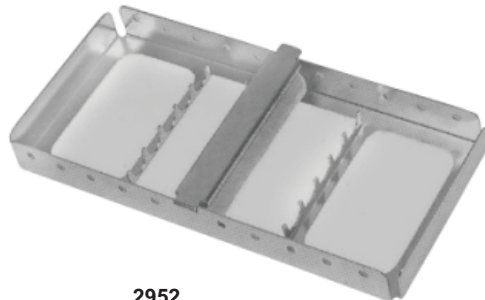

**2952**  
Instruments Tray of 5 Pcs

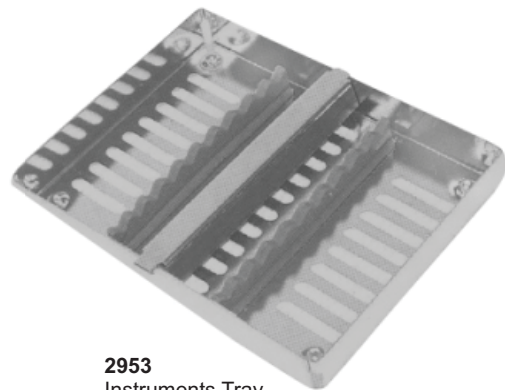

**2953**  
Instruments Tray



**2954**  
Instruments Tray  
Perforated



**2955**  
Instruments Tray  
Perforated Base



**2956**  
Instruments Tray  
Solid Base



**2957**  
Pulpectomy Tray



**2958**  
Sterilizing Box  
Available Sizes:  
17x17x3 cm  
20x10x6 cm  
30x14x6 cm



**2959**  
Endo Tray Box



**2960**  
Finger Cup



**2961**  
Bur Box

**2962**  
Sterilizing Drum  
150x150mm  
175x175mm  
190x190mm  
200x140mm  
200x200mm  
240x120mm  
225x225mm  
240x240mm  
290x160mm



**2963**  
Sterilizing Drum  
280x240mm  
230x150mm  
300x250mm  
340x160mm  
350x250mm  
390x200mm  
380x300mm  
100x100mm  
150x120mm



**2964**  
Instruments Box



**2965**  
Instruments Box



**2966**  
Instruments Box



**2967**  
Instruments Sterilizer  
150x75 mm



**2968**  
Endodontic Box



**2969**  
Sterilizing Box  
320x120 mm



**2970**  
Instruments Tray



**2971**  
Instruments Tray



**2972**  
Instruments Tray  
(Perforated)



**2973**  
Instruments Tray  
Shallow(Mayo)



**2974**  
Scaler Tray  
20.0 x 10.0 x 1.5 cm

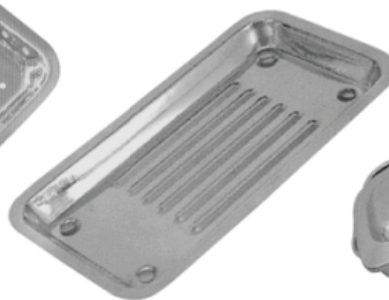

**2975**  
Scalers Tray



**2976**  
Scalers Tray



2982  
Spitten Mug

2983  
Spirit Burner With Wick  
Stainless Steel 18/10  
Capacity: 150 ml, 60 ml

2984  
Spirit Burners With Wick  
Stainless Steel 18/10  
Capacity: 70ml



2985  
Dressing Jar

2986  
Dressing Jar

2987  
Irrigator(Douch Can)

2988  
Measuring Jug



**2989**  
Sponge Bowl

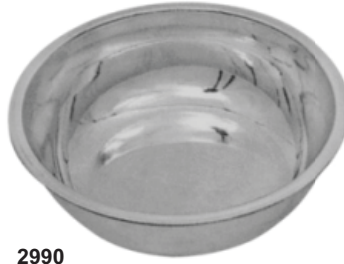

**2990**  
Wash Basin  
300mm-350mm-400mm



**2994**  
Kick Bucket With Trolley



**2991**  
Sponge Bowl



**2992**  
Gallipot



**2993**  
Medicine Cup



**2995**  
Kidney Tray Shallow  
150mm-200mm-240mm-300mm



**2996**  
Kidney Tray Without Lid  
150mm-200mm-250mm-300mm



**2997**  
Kidney Tray With Lid  
150mm-200mm-250mm-300mm

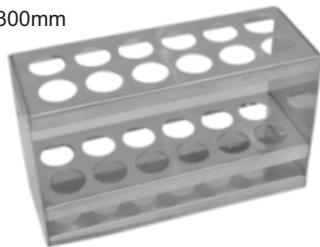

**2998**  
Tube Rack, Stainless Steel 18/10

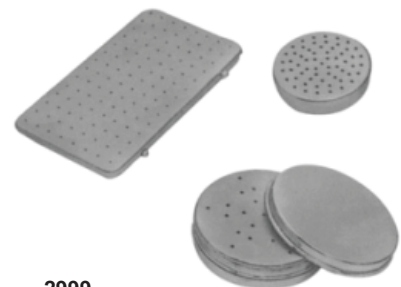

**2999**  
Needle Case Rectangle  
Needle Case Round With Cover  
90x15



**3000**  
Dustbin Without Stand  
6-10-12 Ltr



**3001**  
Tube Rack, Round Model  
Stainless Steel 18/10



**3002**  
Dustbin Without Stand & Cap  
6-10-12 Ltr

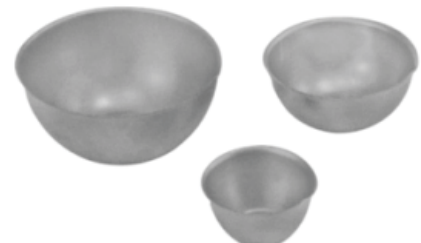

**3003**  
Lotion Bowl With Lip  
40-60-80-100-120-150-180-200mm



**3004**  
Standard



14,5cm  
16,5cm  
18,5cm



**3005**  
Standard



14,5cm  
16,5cm  
18,5cm



**3006**  
Standard



14,5cm  
16,5cm  
18,5cm



**3007**  
Standard

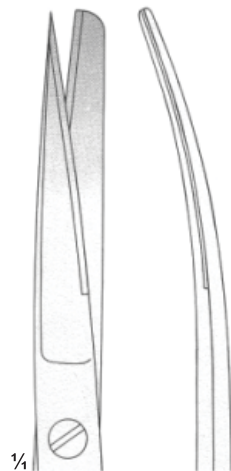

14,5cm  
16,5cm  
18,5cm



**3008**  
Standard



14,5cm  
16,5cm  
18,5cm



**3009**  
Standard

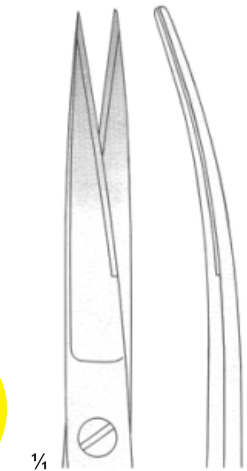

14,5cm  
16,5cm  
18,5cm



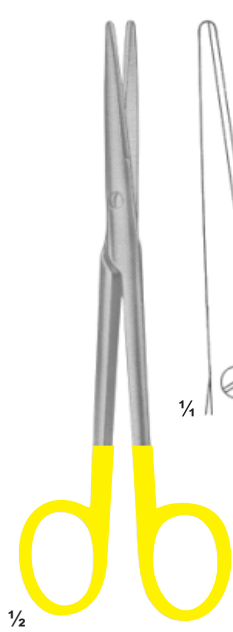

**3010**  
MAYO-LEXER  
Straight  
16 cm

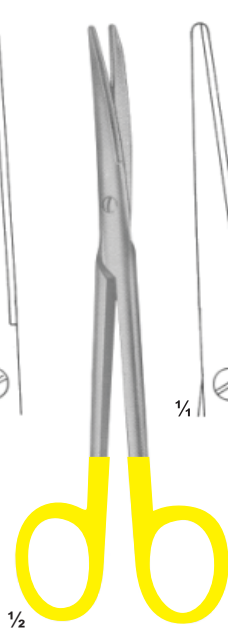

**3011**  
MAYO-LEXER  
Curved  
16 cm

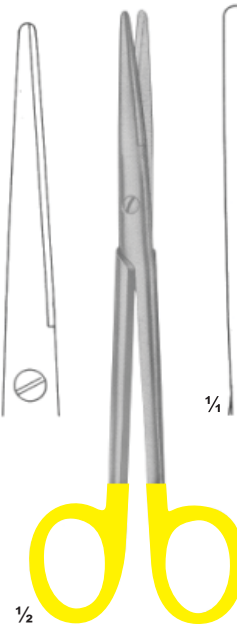

**3012**  
LEXER  
Straight  
16, 21 cm

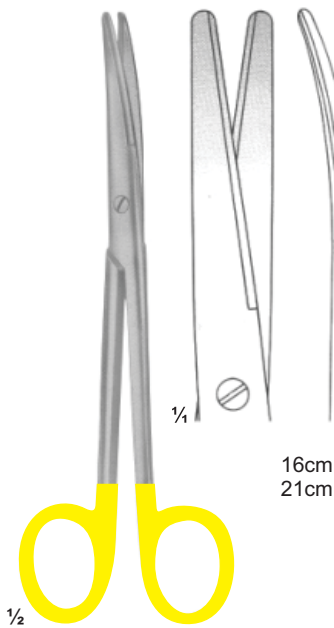

**3013**  
LEXER  
Curved  
16, 21 cm

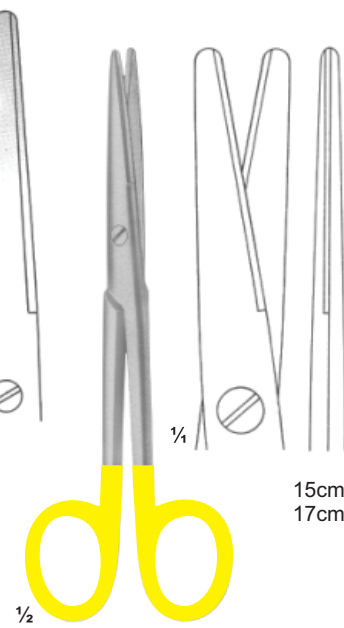

**3014**  
MAYO-STILLE  
Straight  
15, 17 cm

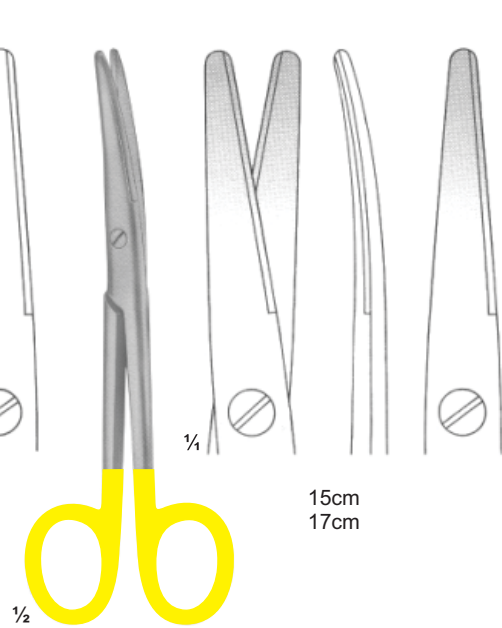

**3015**  
MAYO-STILLE  
Curved  
15, 17 cm

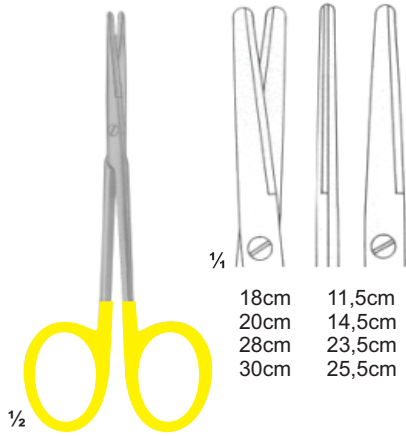

18cm 11,5cm  
20cm 14,5cm  
28cm 23,5cm  
30cm 25,5cm

**3016**  
METZENBAUM  
Straight

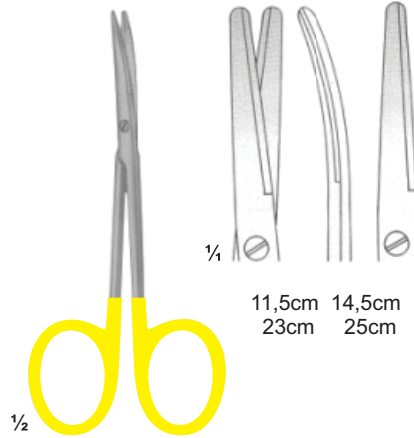

11,5cm 14,5cm  
23cm 25cm

**3017**  
METZENBAUM  
Curved

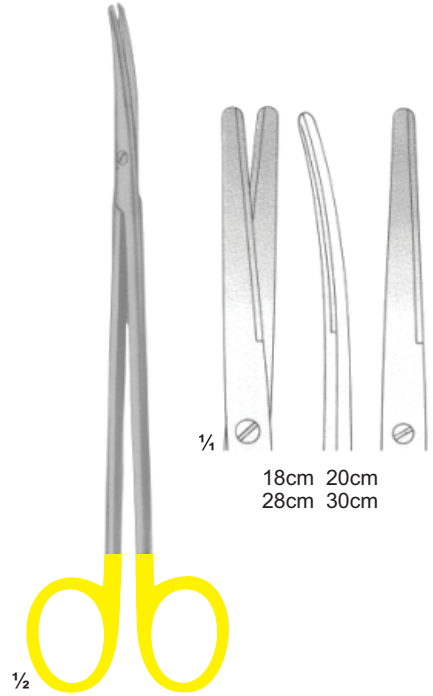

18cm 20cm  
28cm 30cm

**3018**  
METZENBAUM  
Curved



14cm 18cm 20cm  
23cm 25cm 28cm

**3019**  
METZENBAUM FINO  
Straight

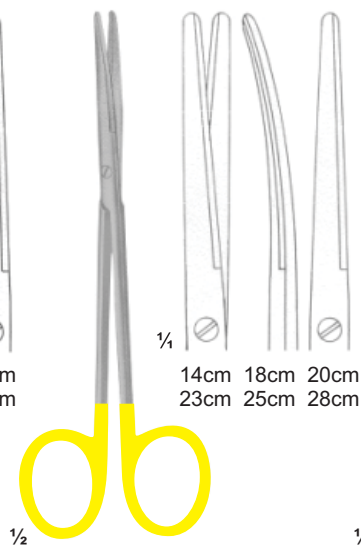

14cm 18cm 20cm  
23cm 25cm 28cm

**3020**  
METZENBAUM FINO  
Curved

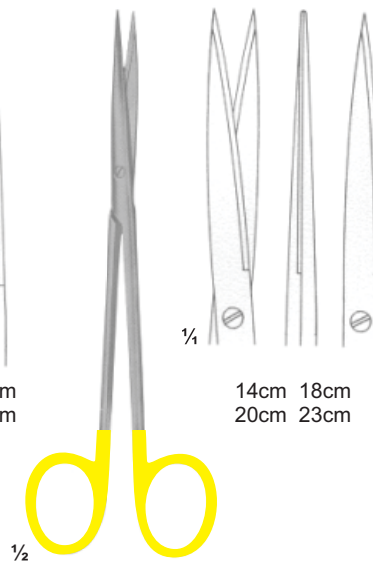

14cm 18cm  
20cm 23cm

**3021**  
METZENBAUM FINO  
Sharp

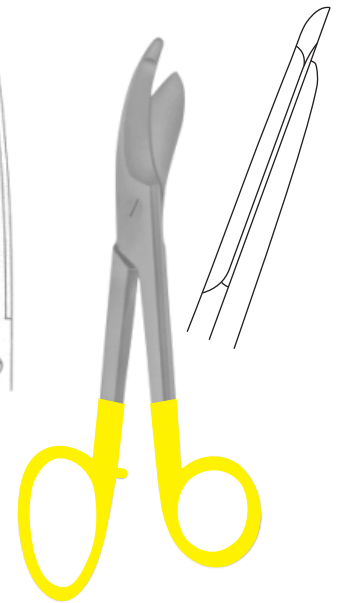

**3022**  
BRUNS  
235 mm

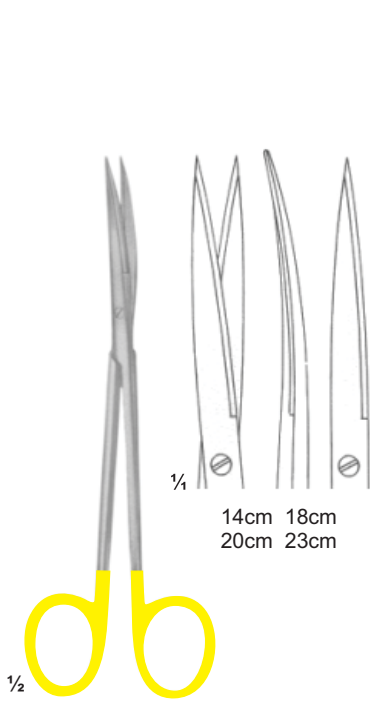

3023  
METZENBAUM FINO

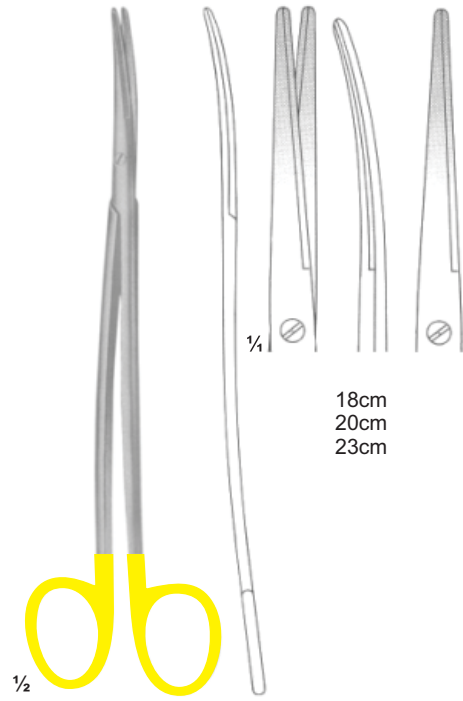

3024  
METZENBAUM FINO

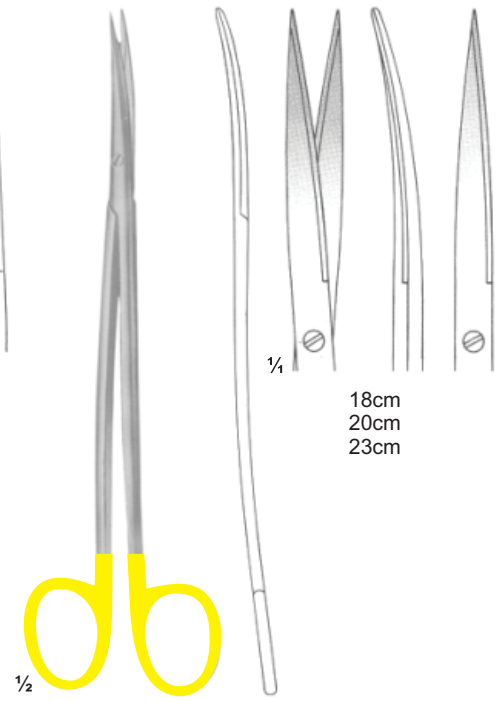

3025  
METZENBAUM FINO

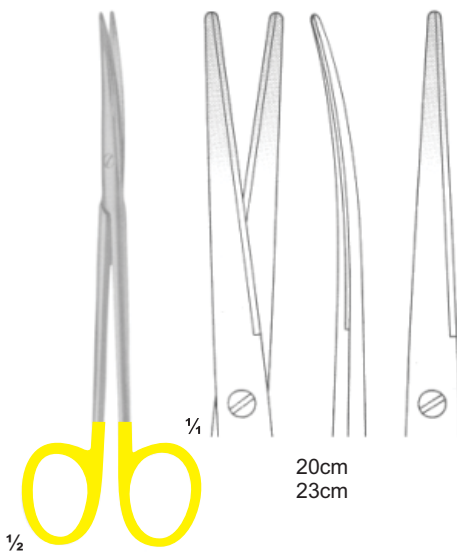

3026  
METZENBAUM FINO

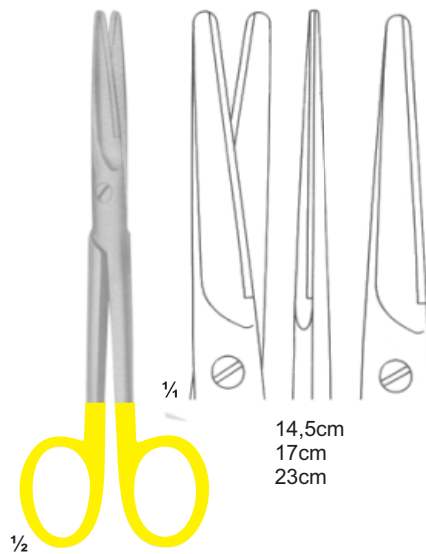

3027  
MAYO  
Straight

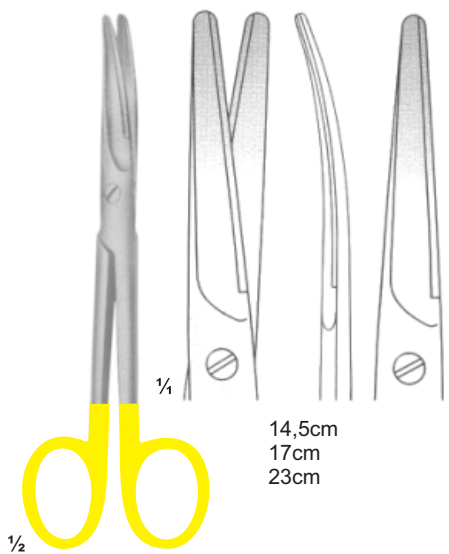

3028  
MAYO  
Curved

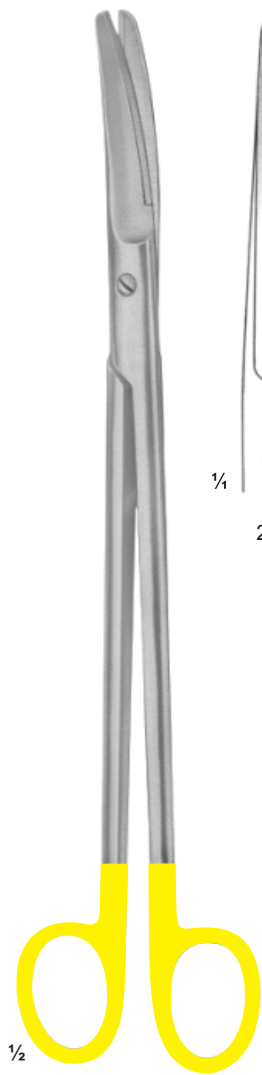

3029  
SIMS

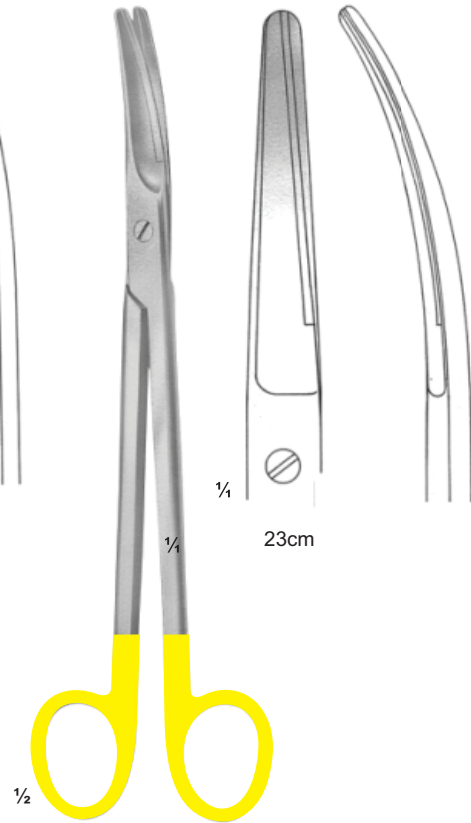
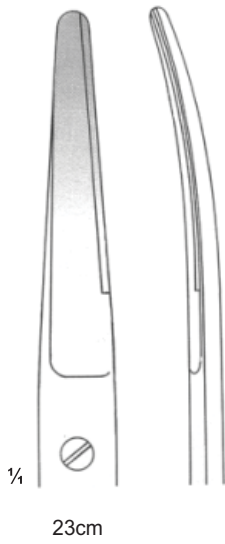

3030  
PARAMETRIUM

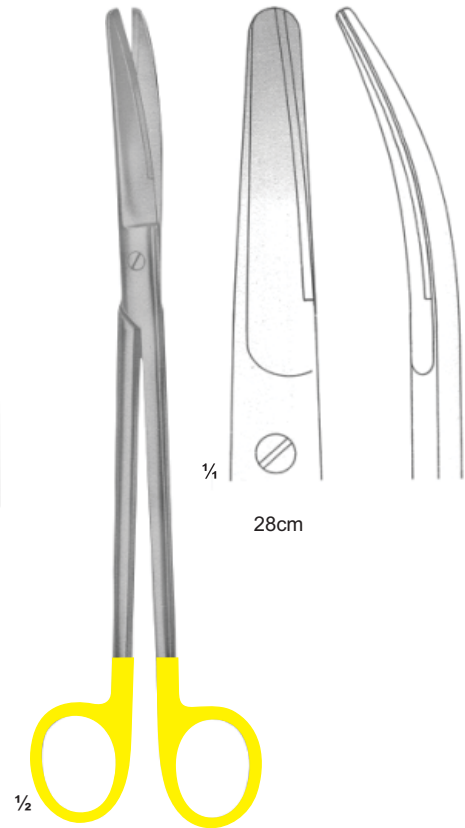

3031  
MAYO-HARRINGTON



3032  
KELLY  
Straight 16 cm



3033  
KELLY  
Curved 16 cm



3034  
DEAN  
17 cm

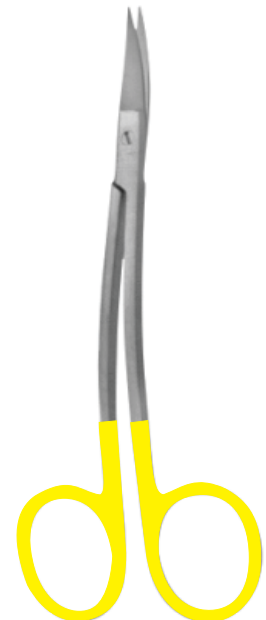

3035  
LAGRANGE  
Double-Curved  
11.5 cm



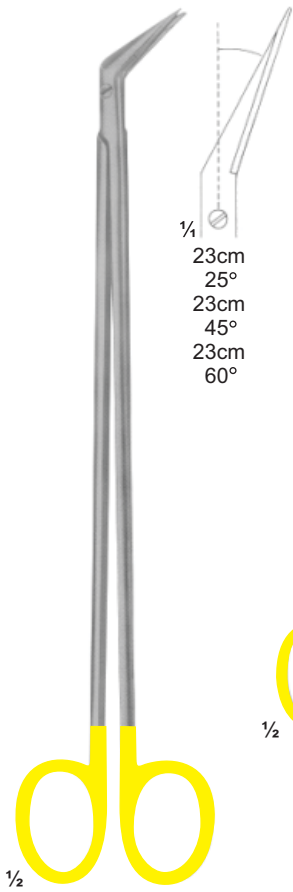

**3036**  
DE-BAKEY



**3037**  
DE-BAKEY

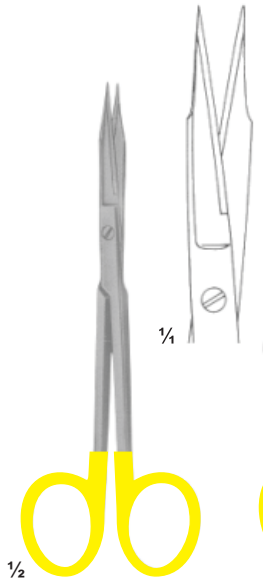

**3038**  
GOLDMAN FOX  
13 cm

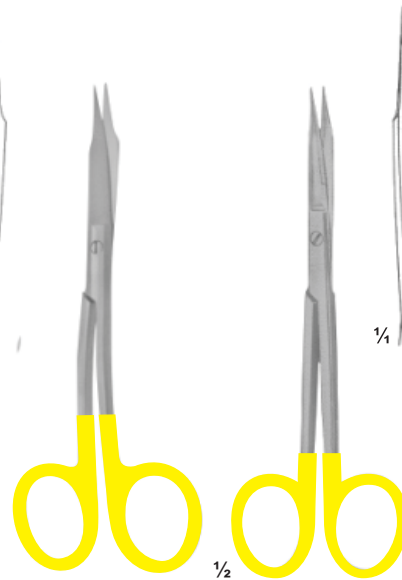

**3039**  
GOLDMAN FOX  
Double-Curved  
13 cm

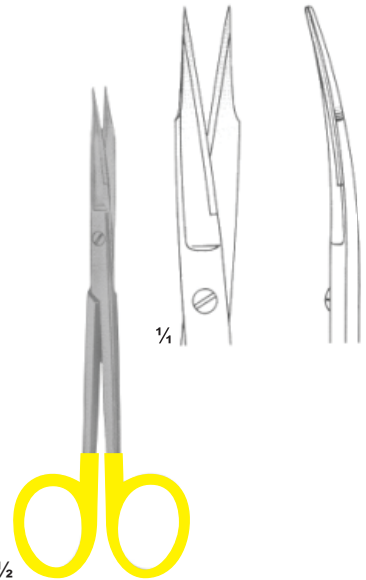

**3040**  
GOLDMAN FOX  
13 cm

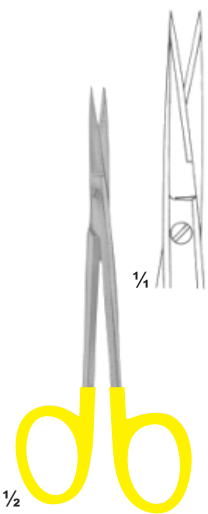

**3041**  
Fine Scissors  
Straight  
11, 5 cm

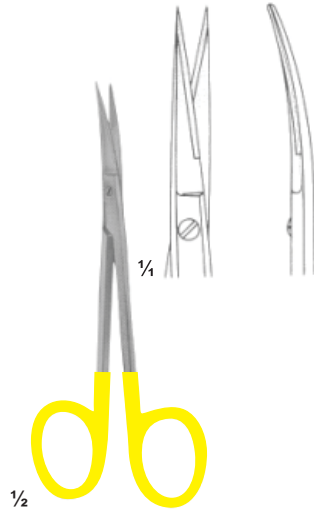

**3042**  
Fine Scissors  
Curved  
11, 5 cm

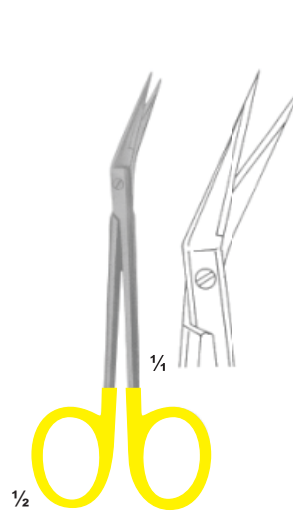

**3043**  
Fine Scissors  
Angled  
11, 5 cm

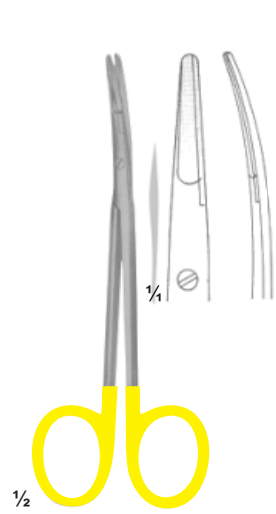

**3044**  
RAGNELL  
Curved  
12 cm

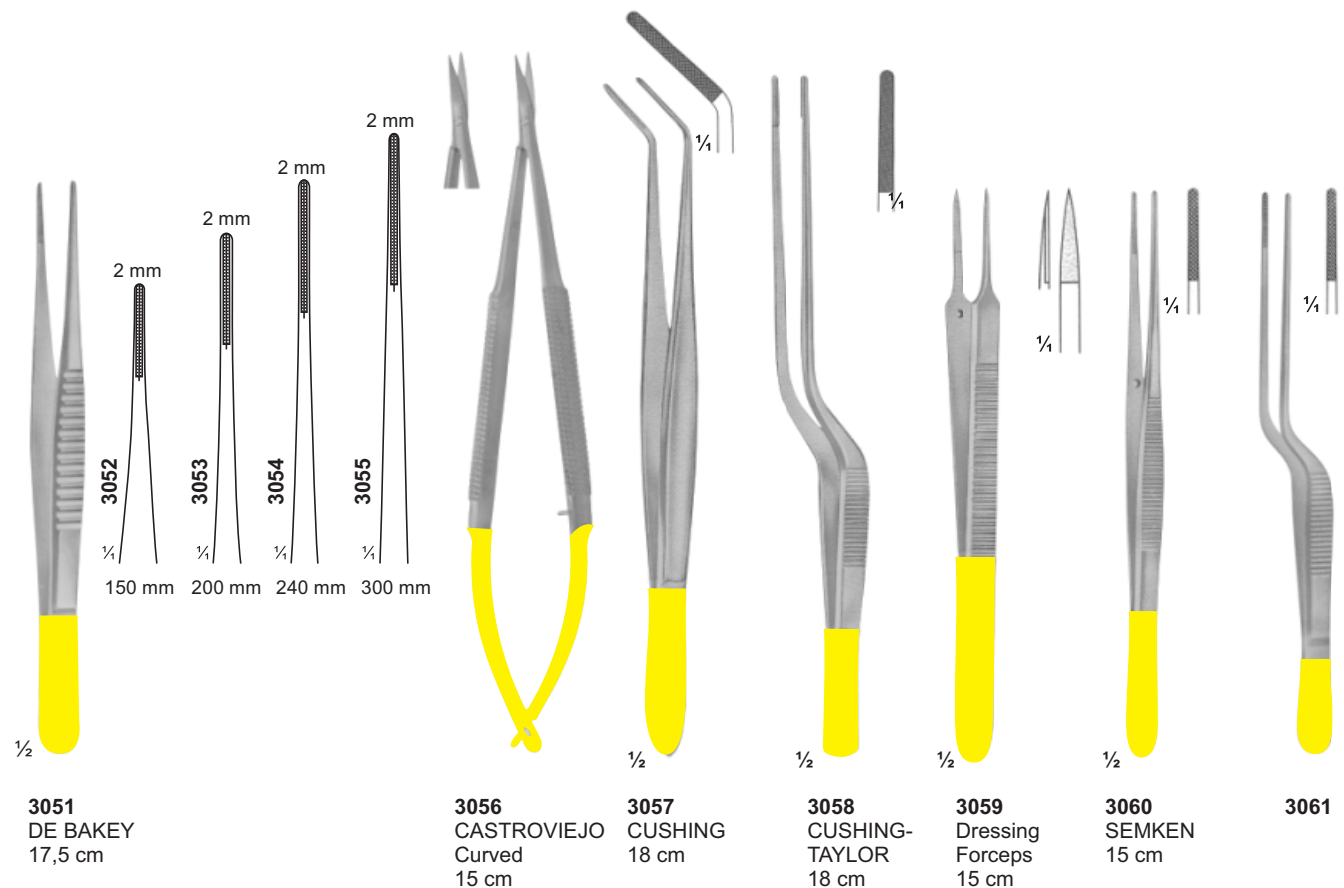
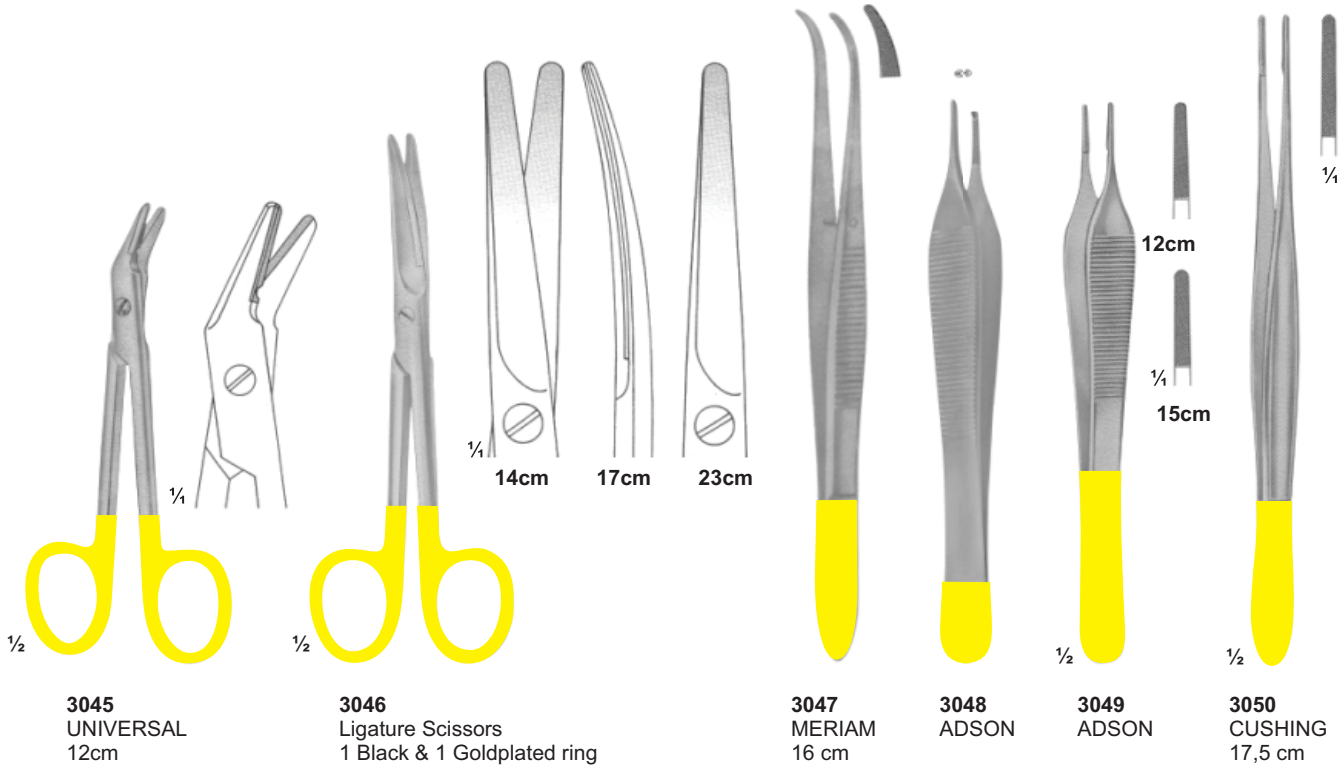

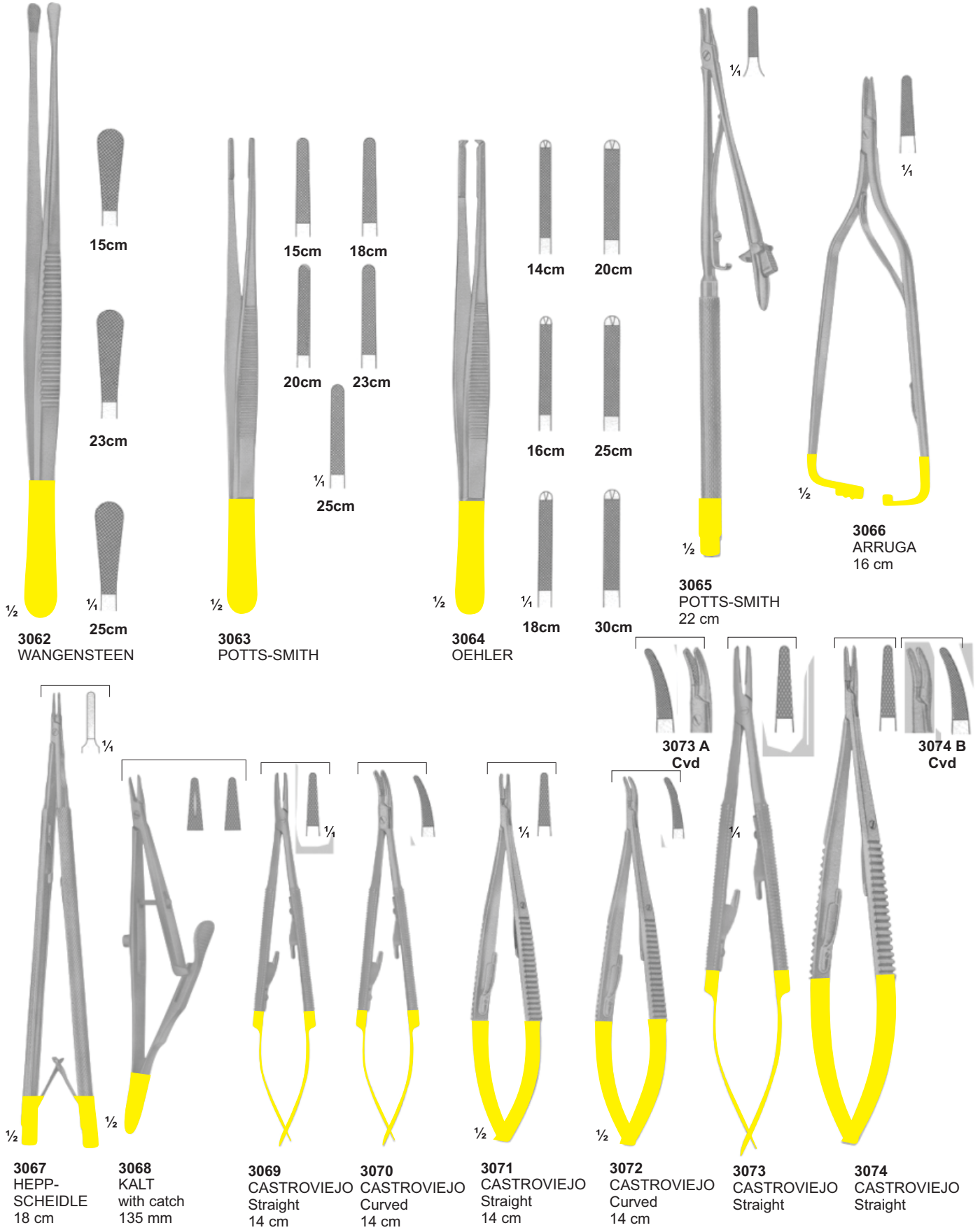

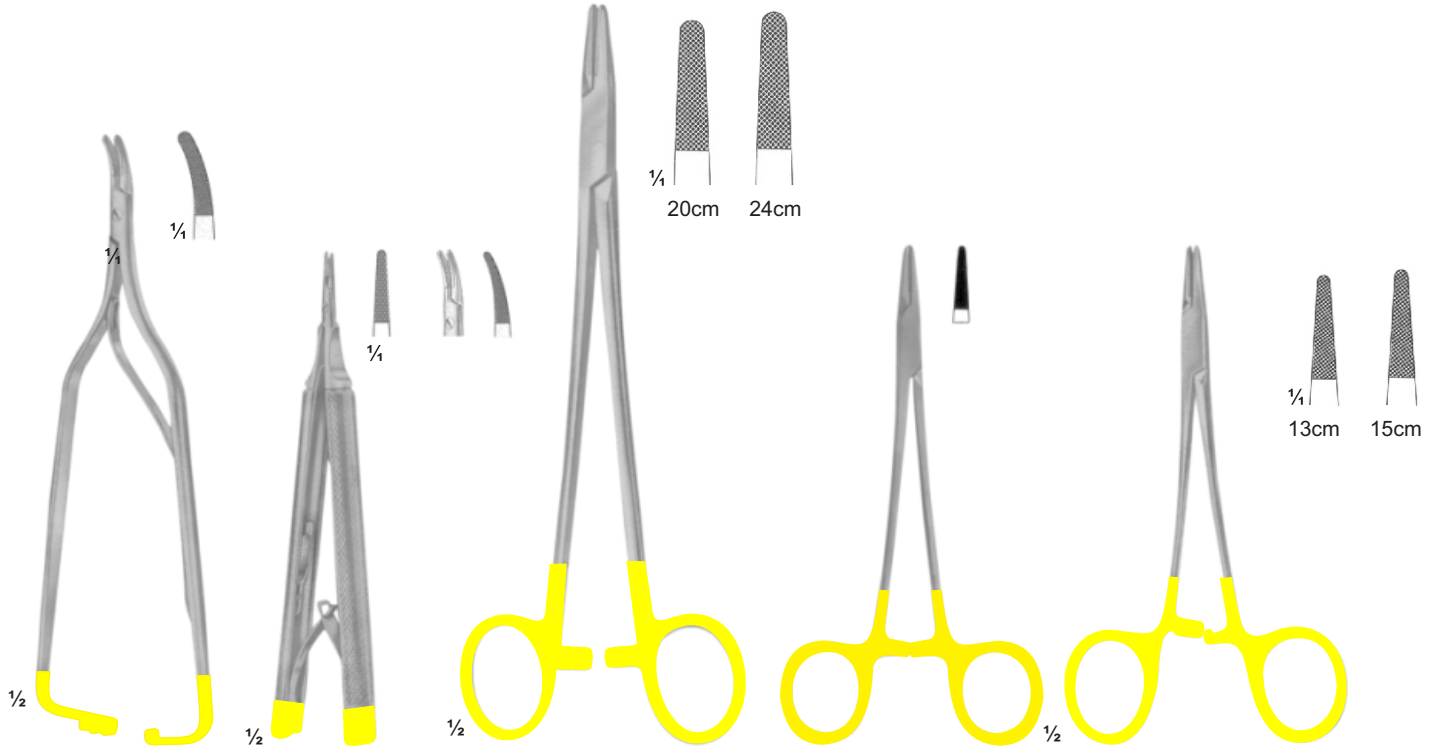

**3075**  
ARRUGA  
Curved  
16 cm

**3076**  
CASTROVIEJO  
13 cm

**3077**  
HEGAR  
20,24 cm

**3078**  
SMOOTH TIP  
15 cm

**3079**  
HALSEY  
13,15 cm

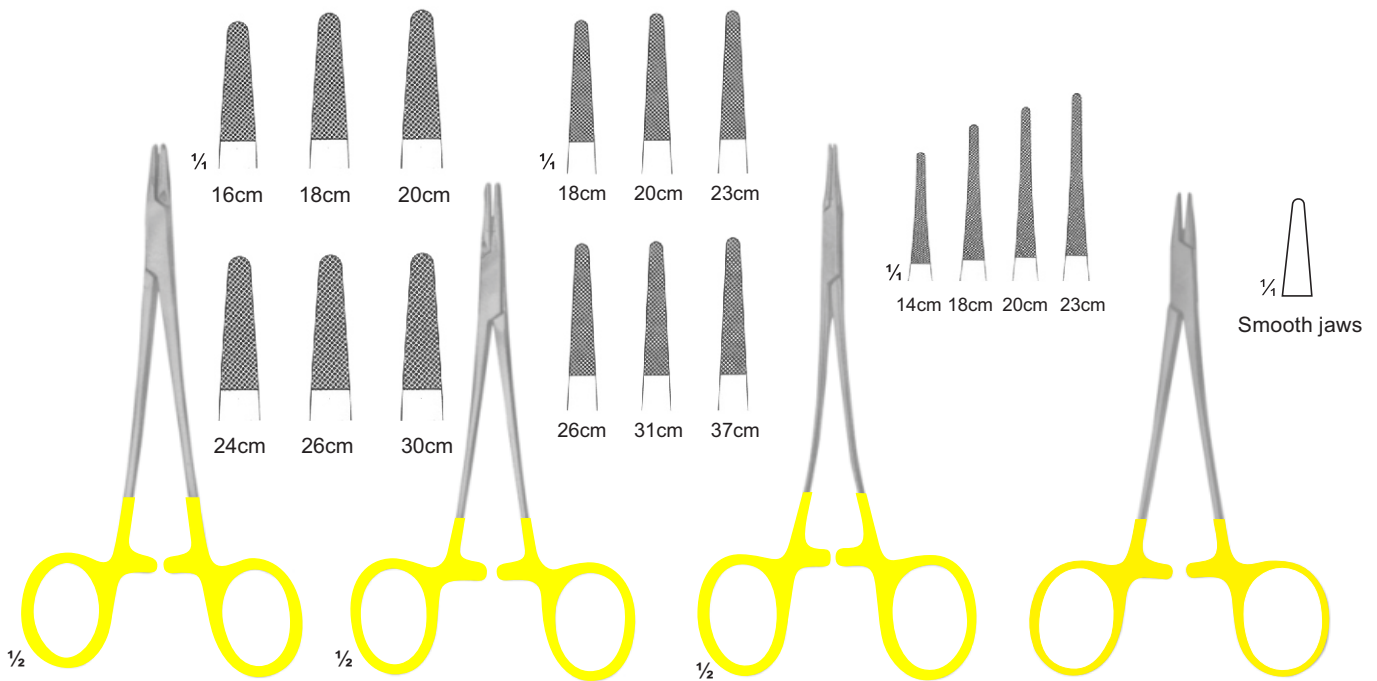

**3080**  
MAYO-HEGAR

**3081**  
DE BAKEY

**3082**  
HEGAR-VASCULAR

**3083**  
WEBSTER  
125 mm

1/4  
Smooth jaws



# Needle Holders With Tungsten Carbide Inserts

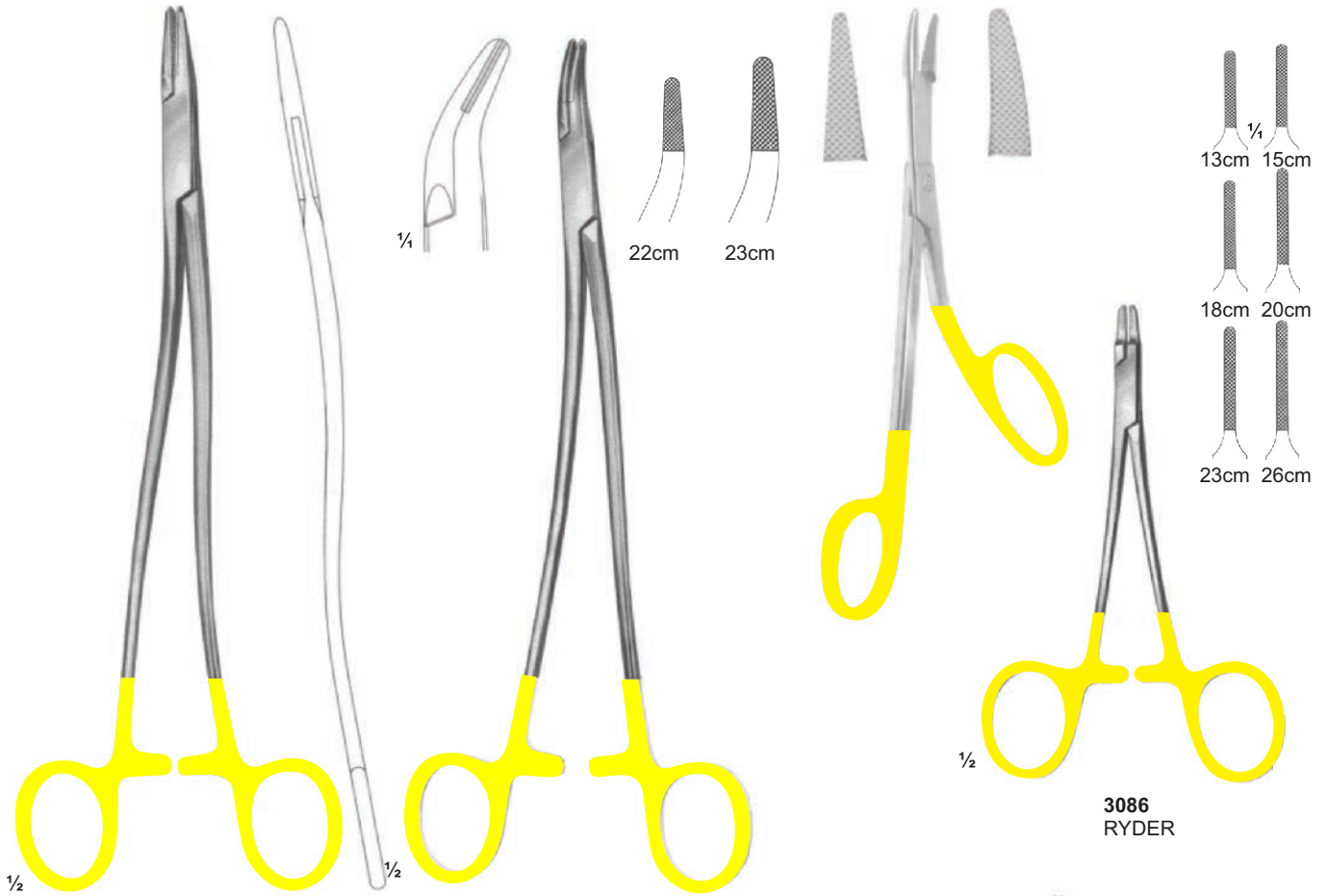

**3084**  
BOZEMANN-WERTHEIM  
20, 24, 26 cm

**3085**  
STRATTE

**3086**  
RYDER



**3087**  
RYDER-VASCULAR

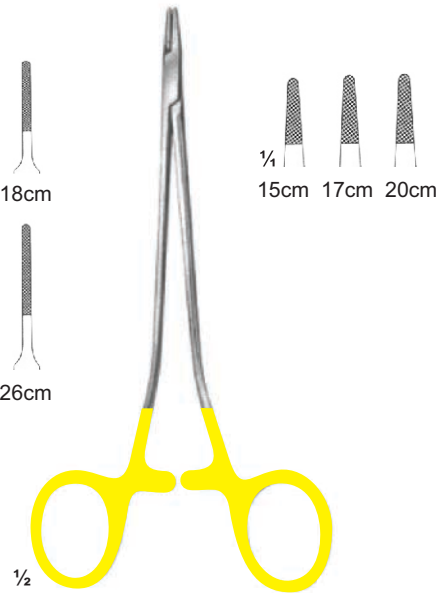

**3088**  
MARTIN

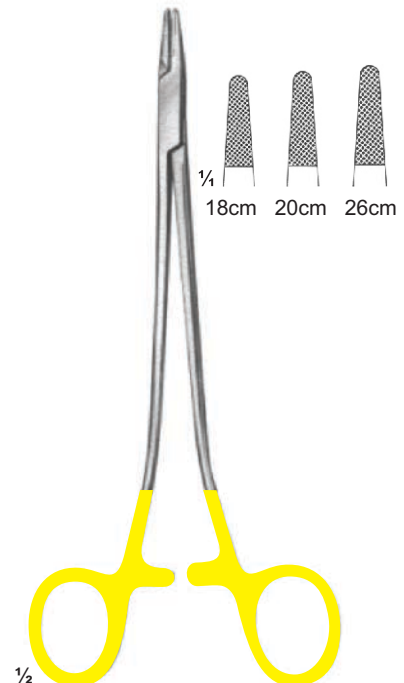

**3089**  
SAROT

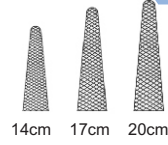

**3090**  
FINOCHIETTO  
27 cm

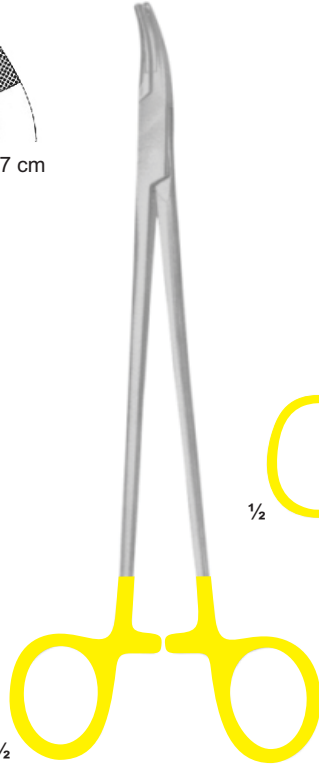

**3091**  
HEANEY  
27,24 cm

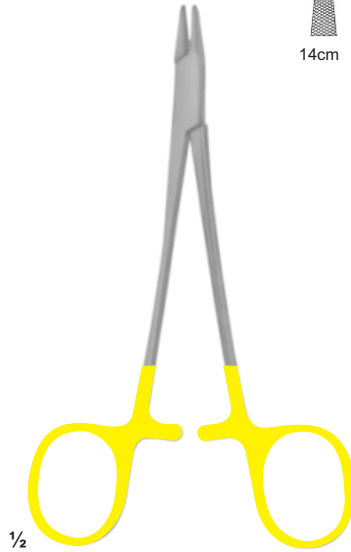

**3092**  
BAUMGARTNER  
145 mm

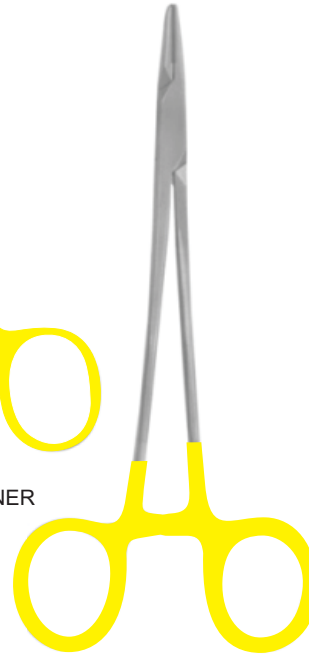

**3093**  
CRILE-WOOD  
15 cm



**3094**  
MATHIEU



**3095**  
MATHIEU  
14,17,20 cm



**3096**  
MATHIEU-KOSHER  
14,17,20,24 cm



**3097**  
MATHIEU-KOSHER  
17,20,24 cm



**3098**  
MATHIEU-VASCULAR  
17,20,24 cm



**3099**  
MATHIEU-VASCULAR  
Hosel  
17,20 cm

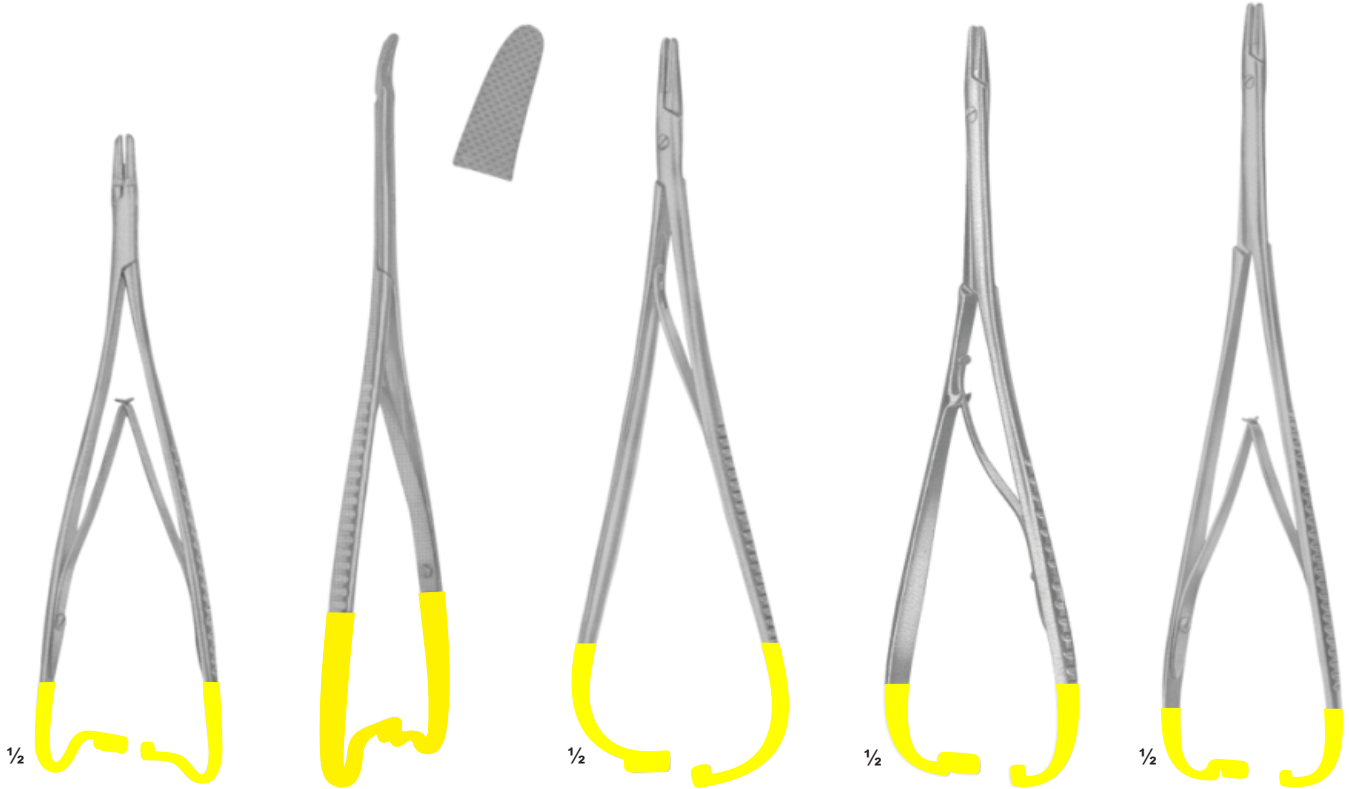

**3100**  
MATHIEU-RYDER  
17,20,24 cm

**3101**  
Hosel  
Curved  
20 cm

**3102**  
LICHTENBERG  
20 cm

**3103**  
LANGHALS  
20,25 cm

**3104**  
LICHTENBERG  
20,25 cm

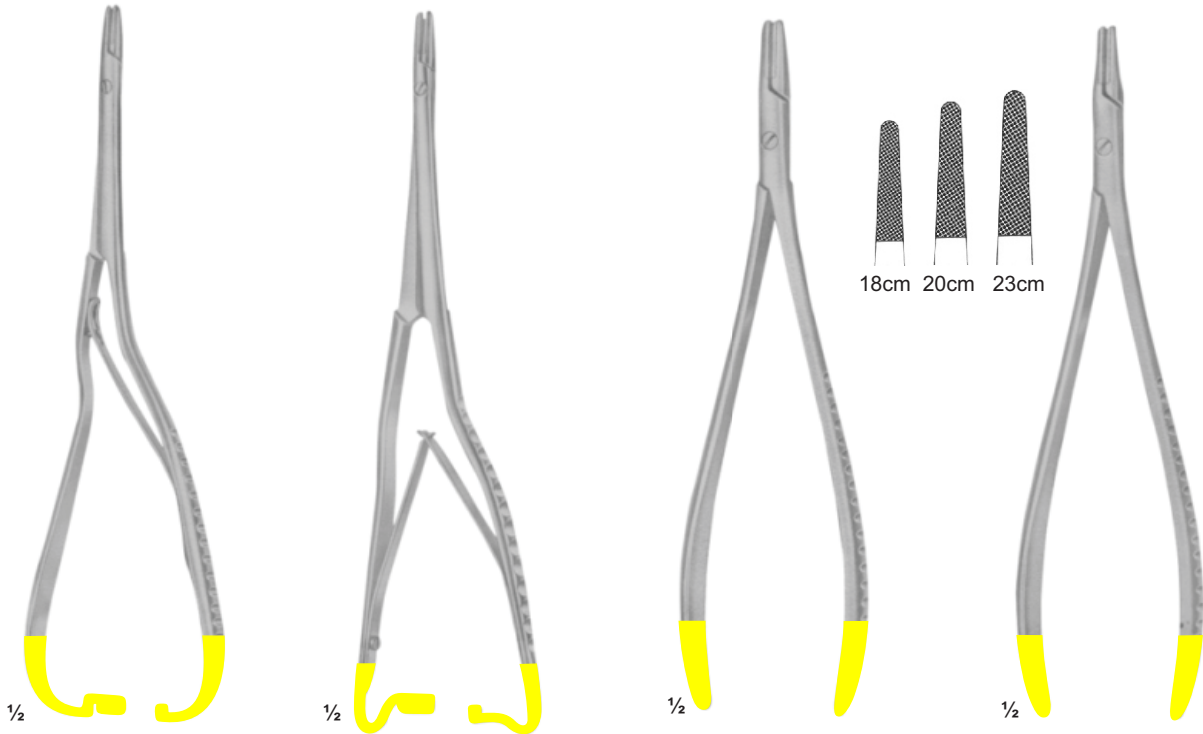

**3105**  
LUEHTY-BECK  
20,25 cm

**3106**  
LUEHTY-BECK  
20,25 cm

**3107**  
LANGENBECK  
18,20,23 cm

**3108**  
LANGENBECK  
18,20,23 cm



**3109**  
TOENNIS  
Elastic pattern for  
dura-or intestinal suture  
180 mm



**3110**  
Cutting Plier  
12 cm

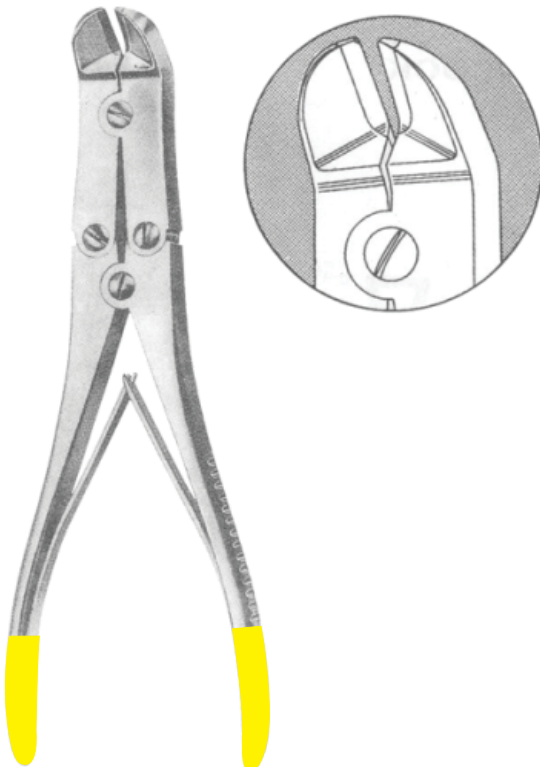

**3111**  
MULLAR CLAUS  
22 cm

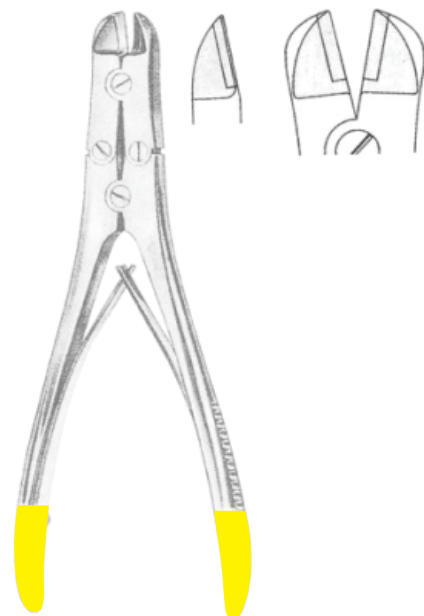

**3112**  
Plier  
17.5 cm



**3201**  
Root Elevator



**3202**  
Root Elevator



**3203**  
Osteotomes  
Pointed



**3204**  
Osteotomes  
Pointed



**3205**  
Osteotomes Convex  
Rounded Set of Five



**3206**  
Luxator Set 7 Pcs

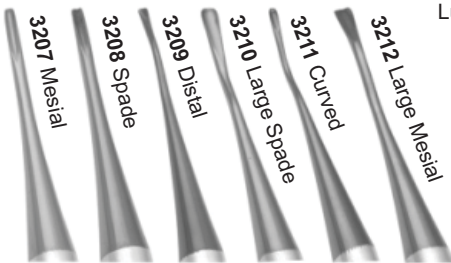

**3213**  
Periodontal chisel  
5mm / 3mm



**3214**  
Sinus lift # 1  
Set of Five

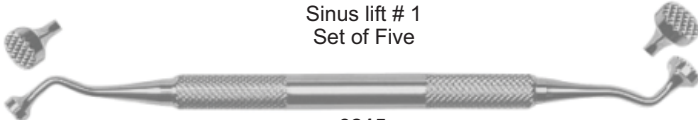

**3215**  
Large Bone Packer  
Serrated 5mm 7mm



**3216**  
Labanca



**3217**  
Sinus lift instruments



**3218**  
Sinus lift instruments



**3219**  
Replacement blade bone scraper  
(curved) Three Type



**3220**  
Adjustable-angle  
Scalpel Blade Handle



**3221**  
Replacment Blade  
Bone Screper (streight)



**3222**  
Bone Tamper 4mm  
Searted Tip



**3223**  
Bone Chisel



**3224**  
Double Ended  
Explorer



**3225**  
Scaler



**3226**  
Scaler



**3227**  
Scaler



**3228**  
Scaler





**3229**  
Frazier Suction tube  
2.5 mm diameter



**3230**  
luxator set 7 pcs  
mesial curved



**3231**  
luxator set 7 pcs  
mesial curved



**3232**  
Bone Grafting  
Syringe



**3233**  
inter-ligmental  
Syringes



**3234**  
inter-ligmental  
Syringes



**3235**  
Adjustable Torque  
Wrench



**3236**  
Mucotomes  
(straight)



**3237**  
Bone Miller

**3238**  
Bone Well

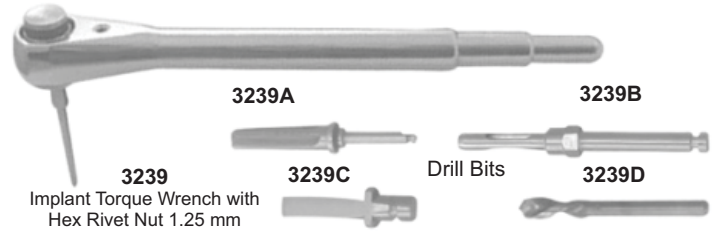

**3239A**  
**3239**  
Implant Torque Wrench with  
Hex Rivet Nut 1.25 mm

**3239B**  
**3239C** **3239D**  
Drill Bits



**3240**  
Fig. 1 / Hemingway

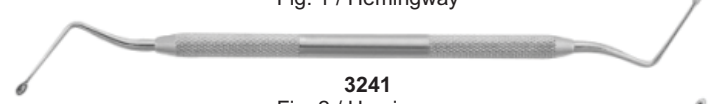

**3241**  
Fig. 2 / Hemingway

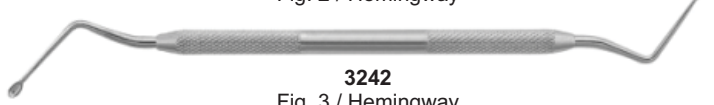

**3242**  
Fig. 3 / Hemingway



**3243**  
Fig. 3

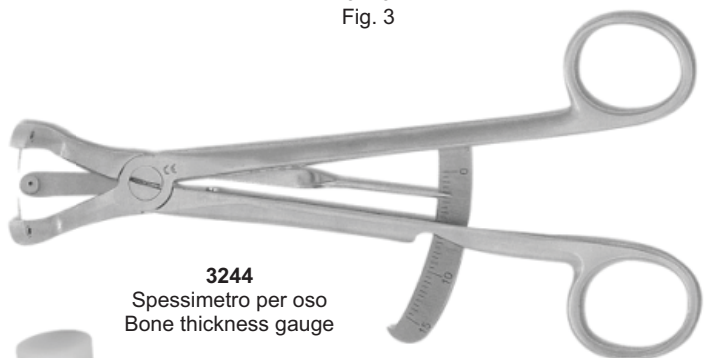

**3244**  
Spessimetro per oso  
Bone thickness gauge



**3245**  
MALLET



**3246**  
Dental implant fixture  
removal kit

- >trephines
- >drivers
- >end cutters

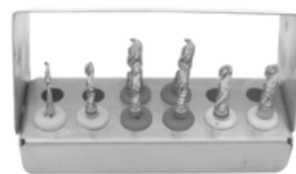

**3247**  
Dental Trepine Drills  
Set of Seven

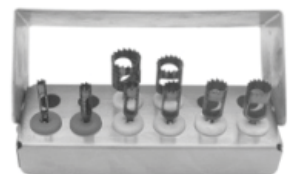

**3248**  
Dental Trepine Drills  
Set of Ten



**3249**  
Set of 8 Pcs

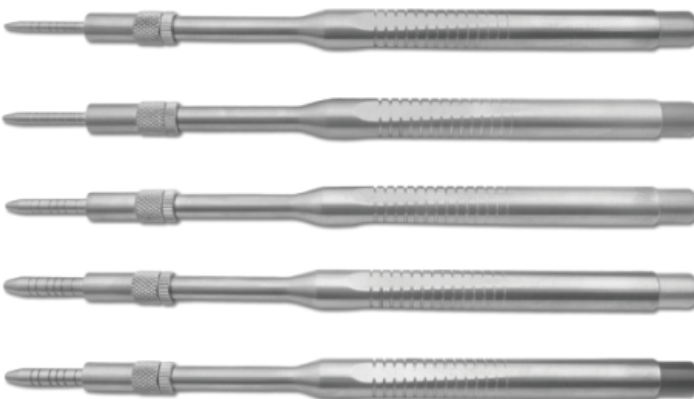

**3250**  
Set of 5 Pcs



**3251**  
Set of 5 Pcs



**3252**  
Set of 7 Pcs





**3253**  
Tooth Extracting Forceps Kit (Set of 12 pcs)  
Fig #: 1,7,13,17,18,51A,67A,73,74N,86,89,90



**3254**  
Pedo Forceps Kit (Set of 7 pcs)  
Fig #: 560,561,562,563,565,566,567



**3255**  
Root Elevators Kit (Set of 9 pcs)  
A) Cross Bar Elevator #775/7  
B) Cross Bar Elevator # 775/8  
C) Elevator, Str. Hospital Pattern (Semi-Pointed)  
D) Elevator-Coupland Back Crurver #2 (Lindoleven)  
E) Elevator # 720/10  
F) Elevator # 120/11  
G) Elevator # 720/27  
H) Elevator # 720/28



**3256**  
Oral Surgical Instruments Kit  
A) B.P. Handle # 3 - Round, Str.  
B) Artery Forceps, Str. 5.5"  
C) Needle Holder, Str. 6"  
D) Gum Scissors # 1  
E) Gum Scissors # 2  
F) Moons Probe, (Flat Beak)  
G) Bone Curettes # 780 (Lucas)  
H) Bone Nibbler, Large with Hole  
J) Periosteal Elevator



**3257**  
Crown Remover Set  
Full Automatic



**3258**  
Rubber Dam  
Instruments Set



**3259**  
Gracey Curettes, (Set of 8 pcs)  
Fig # 1/2,3/4,5/6,7/8,9/10,  
11/12,13/14,15/16



**3260**  
Subgingival Scalers  
(Set of 8 pcs S/E)



**3261**  
Titanium Coated Filling Instruments  
Hollow Handle (Set of 6 pcs)



**3262**  
Titanium Coated Filling Instruments  
(Set of 6 pcs)







**993**  
Physics Forceps Set of 4 Pcs



**994**  
Root Elevators Set of 7 Pcs



**995**  
P.K. Thomas Set of 5 Pcs



**996**  
Luxator Set of 10 Pcs



**997**  
Automatic Crown Remover  
Set of 4 Pcs



**998**  
Laboratory Instruments Set of 10 Pcs



**987**  
Root Elevator Set of 7 Pcs



**988**  
Root Elevator Set of 7 Pcs



**989**  
Impression Tray  
Set of 10 Pcs



**990**  
Root Elevator Set of 7 Pcs



**991**  
Rubber Dam Kit



**992**  
Orthodontic Kit



A

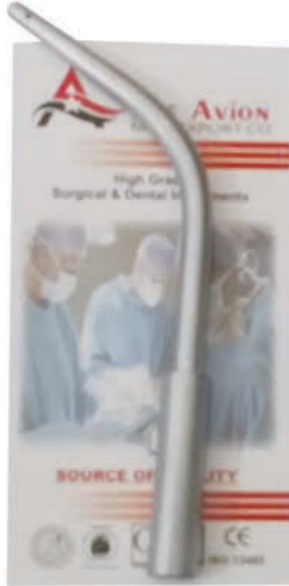

B



C



D

**999**  
Suction Tubes  
Set of 4 Pcs



**1000**  
Dental Laboratory Saw



## Alphabetical Index



<b>A</b>	
Adams, Pliers	174
Aderer, Pliers	174
Adson, Forceps	158,207
Adson, Tweezers	151
Ainsworth, Rubber Dam Punch	147
Albee	143
Albrecht, Tweezers	155
Allen, Tweezers	155
Allis, Tissue Forceps	158
Amalgam Applicators	97
Amalgam Condensers	97
Amalgam Pluggers	97
Amalgam Carriers	145
Amalgam Guns	145
Andresen, Pliers	175
Andrews, Tongue Depressor	160
Angle, Pliers	169,174
Apical, Elevator	57,63
Arruga, T.C. Needle Holder	208,209
Articulators	194-195
Aspirating Syringes	149
Allen 9A, Elevator	50
<b>B</b>	
Baby-Allis, Tissue Forceps	158
Band Removing Pliers	170
Bane, Rongeurs	179
Barnhart, Curettes	110,116
Barry, Elevator	66,69
Baum Gartner, Needle Holder	180,211
Bee Be, Scissors	186
Bein, Elevator	54,61
Beyer, Rongeurs	179
Bird Beak Pliers	167
Blumenthan, Rongeurs	176
Boley Gauge	143
Bone Curettes	129
Boynton, Needle Holder	181
Bozemann-Wertheim, T.C. Needle Holder	210
Bracket, Pliers	170
Brewer, Rubber Dam Instruments	147
Brown, Tissue Forceps	158
Brown-Adson, Tissue Forceps	158
Bruns, T.C. Scissors	203
Buchs, Retractor	162
Burnishers	99-100
Ball Chain	146
Boley Gauge,	143
Bone Gauge,	144
Bone Mill Forcep,	139
Bone Pluggers,	140
Bracket, Gauge	144
Buser, Elevator	52
<b>C</b>	
Carvers	102,103
Castroviejo, Needle Holder	181,208,209
Castroviejo, scissors	186
Castroviejo, Gauge	144
Castroviejo, Sclerer Marker	144
Cement Instruments	118,119,121
Cement Spatulas	120,122
Chisels	103
Chompret, Elevator	63
Cleveland, Rongeurs	177,178
College, Tweezers	152,154
Collier, Needle Holder	180
Collin, Retractor	162
Columbia, Curettes	110,111,116
Composite Placement	104,105
Con Scodellino, Wax Knives	126
Cord Packers	95
Cottle, Scissors	184
Coupland, Elevator	58
Crane-Kaplan	128
Crile, Forceps	157
Crile, Needle Holder	181
Crile-Wood, Needle Holder	180
Crown Instruments	135,136
Crown Removers	134,135
Crown Shell, Pliers	166
Cryer, Elevator	55,58,69
Cushing , T.C. Forceps	207
Cushing, Tweezers	151
Cushing-Taylor , T.C. Forceps	207
<b>D</b>	
De Bakey , T.C. Forceps	207
De Bakey, Scissors	184,186,206
De Bakey, T.C. Needle Holder	209
De La Rosa, Pliers	169
Deaver, Scissors	184
Denhart, Mouth Gag	160
Dental Implants Instruments	214,216
Dental Instruments Sets	217
Derf, Needle Holder	180
Disposable Products	117
Dr.Sader, Elevator	69
Dressing Forceps	207
Dean Scissors	186,205
<b>E</b>	
Elevators	51
Endodontic Condensers	86,87
Ernert, Wax Knives	126
Excavators	89-91
Explorers	80-82,91-94
Extracting forceps (American Pattern)	36-49
Extracting forceps (English Pattern)	1-24
Extracting forceps (fitting handle)	25-33
Extracting forceps (For Children)	34
<b>F</b>	
Fahnenstock, Wax Knives	126
Files	125
Filling Instruments	106,107
Fine, T.C. Scissors	206
Finochietto, T.C. Needle Holder	211
Finochietto, T.C. Needle Holder	211
Fischer, Pliers	175
Flagg, Tweezers	154
Flohr, Elevator	56
Fomon, Tissue Retractor	164
Freer, Elevator	52
Friedman, Rongeurs	178
Furrer, Pliers	174
Film Hanger	146
Finger Cup	197
Flohr, Elevator	57
Freer	15,16





# Alphabetical Index



Elevator	52	Langenbeck, Retractor	162
<b>G</b>		Langenbeck, T.C. Needle Holder	212
Gardner, Bone Chisels	132	Langer, Curettes	110,116
Gardner, Needle Holder	180	Langhals, T.C. Needle Holder	212
Gardner, Rongeurs	178	Lecluse, Elevator	65
Gillies, Hook	164	Lessmann, Wax Knives	126
Gillies, Tweezers	151	Lexer, T.C. Scissors	202
Goldman Fox , T.C. Scissors	206	Lichtenberg, T.C. Needle Holder	212
Goldman Fox, Curettes	112,113	Ligature , T.C. Scissors	207
Goldman Fox 14, Elevator	50	Lip & Cheek Retractors	161,162
Goldman Fox, knives	114	Lister, Scissors	184
Goslee, Pliers	175	Littauer, Scissors	186
Gracey Curettes	108,109,116	Littler, Scissors	184
		Locklin, Scissors	186
<b>H</b>		London Hospital, Elevator	62
Halsey, T.C. Needle Holder	209	London-College, Tweezers	154,155
Handles	72	Lucae, T.C. Forceps	
Hartman, Rongeurs	179	Luehty-Beck, T.C. Needle Holder	212
Hatchets	95	Lwanson, Crown Gauge	143
Heaney, T.C. Needle Holder	211	Lagrange, Scissors	186,205
Hegar, T.C. Needle Holder	209	Littaire, Scissors	186
Hegar-Vascular, T.C. Needle Holder	209	Lwanson, Crown Gauge	143
Heidbrink, Elevator	64,67,69	<b>M</b>	
Heidbrink, Elevator	57	Martin, T.C. Needle Holder	210
Howard 9H, Elevator	52	Mathieu, Needle Holder	181,211
Height Gauge,	143	Mathieu-Kosher, T.C. Needle Holder	211
Hepp-Scheidle, T.C. Needle Holder	208	Mathieu-Ryder, T.C. Needle Holder	212
Hlsted-Mosquito, Forceps	159	Mathieu-Vascular, T.C. Needle Holder	211
Hoes	95,125	Mayo Harrington, T.C. Scissors	205
Hollow Wares	196-200	Mayo, Scissors	185,204
How, Pliers	167,174	Mayo-Hegar, Needle Holder	181
Howard, Bone Files	131	Mayo-Hegar, T.C. Needle Holder	209
Hylin, Elevator	61	Mayo-Lexer, T.C. Scissors	202
		Mayo-Stille, T.C. Scissors	202
<b>I</b>		Mayo-Stille Scissors	185
Implants Instruments	137-141	Mc Kellops, Pliers	175
Impression Trays	187-193	Mccalls, Curettes	110,111,116
Iris Scissors	183	Mcindoe, Tweezers	151
Ivory, Rubber Dam Instruments	147	Mead, Bone Mallets	133
		Mead, Elevator	64
<b>J</b>		Mead, Rongeurs	179
Jarabak, Pliers	165	Meriam , T.C. Forceps	207
Jeseeph, Scissors	183	Meriam, Tweezers	153,155
Johnson, Pliers	169,175	Metzenbaum Fino, T.C. Scissors	203,204
Joseph, Tissue Retractor	164	Metzenbaum, Scissors	185,203
		Micro Surgery Set	182
<b>K</b>		Micro-Adson, Tweezers	151
Kalt, T.C. Needle Holder	208	Micro-Friedman, Rongeurs	178
Kelly, Forceps	159	Middledorpf Retractor	162
Kelly, Scissors	183	Miller, Articulating Forceps	147
Kelly Scissors	205	Miller, Bone Files	130
Kim's Plier	165	Mini-Blumenthan, Rongeurs	176
Kirkland, knife	114	Molt, Elevator	50
Knives	125	Molt, Mouth Gag	160
Knowles, Scissors	184	Molt 9, Elevator	50
Kocher, Retractor	162	Morrison, Elevator	56
Kocher-Langenbeck, Retractor	162	Mouth Mirrors with Handles	73
Kopp, Elevator	60,68	MSY, Pliers	175
Kopp , Tweezers	151	Mullar Claus, Wire Cutting Pliers T.C.	213
		<b>N</b>	
<b>L</b>		Nance, Pliers	168,169,174
Lab & Office Pliers	166	Napkin Holders	146
Landgraf, Tweezers	154	Neivert, Needle Holder	180
Langenbeck, Pliers	175	Nelson-Metzenbaum, Scissors	185
		Non Chill	146



## Alphabetical Index

<b>O</b>			
O'Brien, Pliers	168	Spreaders	87
Obturation Instruments	88	Split Chisels,	128
Ochsenbein	128	Spring Bow Divider	143
Ordan, knife	114	Standard, T.C. Scissors	201
Oehler, T.C. Forceps	208	Standard, Tweezers	151
Olsen-Hegar, Needle Holder	180	Steiner, Pliers	166
Optical Pliers	168	Sterilizing & Lab Instruments	156
Orthodontic Cutters, T.C.	172	Sterilizing Forceps,	163
Orthodontic Distal & Cutters	173	Stevens, Needle Holder	181
Orthodontic Pliers, T.C.	171	Stevens, Scissors	183
Ott, Elevator	62	Stille, Scissors	185
<b>P</b>		Stratte, T.C. Needle Holder	210
Parametrium, T.C. Scissors	205	Strip Holder Clips	146
Partsch, Bone Chisels	133	Syringes	150
Partsch, Bone Mallet	133	Suction Tubes,	140,142
Pean, Forceps	157	Sugarman, File	114
Peeso, Pliers	166,175	<b>T</b>	
Peets, Forceps	157	Toennis, Wire Cutting Pliers T.C.	213
Perry, Tweezers	151	Toennis-Adson, Scissors	184
P.K. Thomas,	9696	Toennis, Tissue Retractor	164
Pich,	9898	Towel Clamps, Napkin Holders	159
Pluggers,	9898	Tweed, Pliers	168
Prichard, Elevator	5050	Telescope, Crown Plier	136
Plastic Handle Elevators	70	Traymann, Crown Remover	128
Polokoff, Bone File	131	<b>U</b>	
Pott, Elevator	51	Universal , T.C. Scissors	207
Potts-Smith, T.C. Forceps	208	Universal, Pliers	174
Potts-Smith, T.C. Needle Holder	208	Universal, Elevator	135
Probes	82-85,91,94	Utility Plier	165
<b>Q</b>		<b>V</b>	
Quinby, Scissors	183	Vernier, Measuring Instruments	143
<b>R</b>		Vernier Gauge	143
Ragnell , T.C. Scissors	206	<b>W</b>	
Retainers, Bands	146	Wakefield, Bone Chisels	132
Reynolds, Pliers	169,174	Waldron, Pliers	174
Root Planning Curettes	115	Waldsachs, Pliers	174
Root splinter forceps	35	Wangensteen, T.C. Forceps	208
Roux, Retractor	162	Warwick-James, Elevator	62
Rubber Dam Clamps	148	Waugh, Tweezers	151
Rubber Dam Holder	147	Wax & Modeling Carvers	120
Rule, Curette	110	Wax & Plaster Knives	127
Russian, Tissue Forceps	158	Wax Carvers	101
Ryder, T.C. Needle Holder	210	Wax, Porcelain Instruments	118,119,121
Ryder-Vascular, T.C. Needle Holder	210	Webster, Needle Holder	180,209
<b>S</b>		Weingart , Utility Pliers	167
Sarot, T.C. Needle Holder	210	Weitlaner, Retractor	160
Scalers	75-79	West, Elevator	50
Scalpel Handles	71	White, Rubber Dam Instrument	147
Schwarz, Pliers	168,175	Wieder, Tongue Depressor	160
Schluger, File	114	Winter, Elevator	65,69
Seldin, Elevator	50,55,67	Wire & Clasp Bending Pliers	170
Select, Tweezers	151	Wire Bending Pliers	166
Semken, T.C. Forceps	207	West, Elevator	50
Semkin, Tissue Forceps	158	Wire Cutter	165
Senn, Tissue Retractor	164	Woodson,	98
Separating Pliers	166	<b>Y</b>	
Sims, T.C. Scissors	205	Young, Pliers	168,174
Spatulas	123	<b>Z</b>	
Spencer, Scissors	186	Zuricher, Measuring Instrument	143
Spencer-Wells, Forceps	157	Zuricher, Gauge	143



 **THE AVION**  
MFG. EXPORT. CO

Yasrab Street, Kotli Behram, Sialkot (51310) Pakistan.

Tel: +92-321-9619659 / Fax: +92-524-264558

E-mail: [sales@the-avion.com](mailto:sales@the-avion.com)

[theavionco@gmail.com](mailto:theavionco@gmail.com)

[www.the-avion.com](http://www.the-avion.com)

